

# Assembly Instructions for - 38809

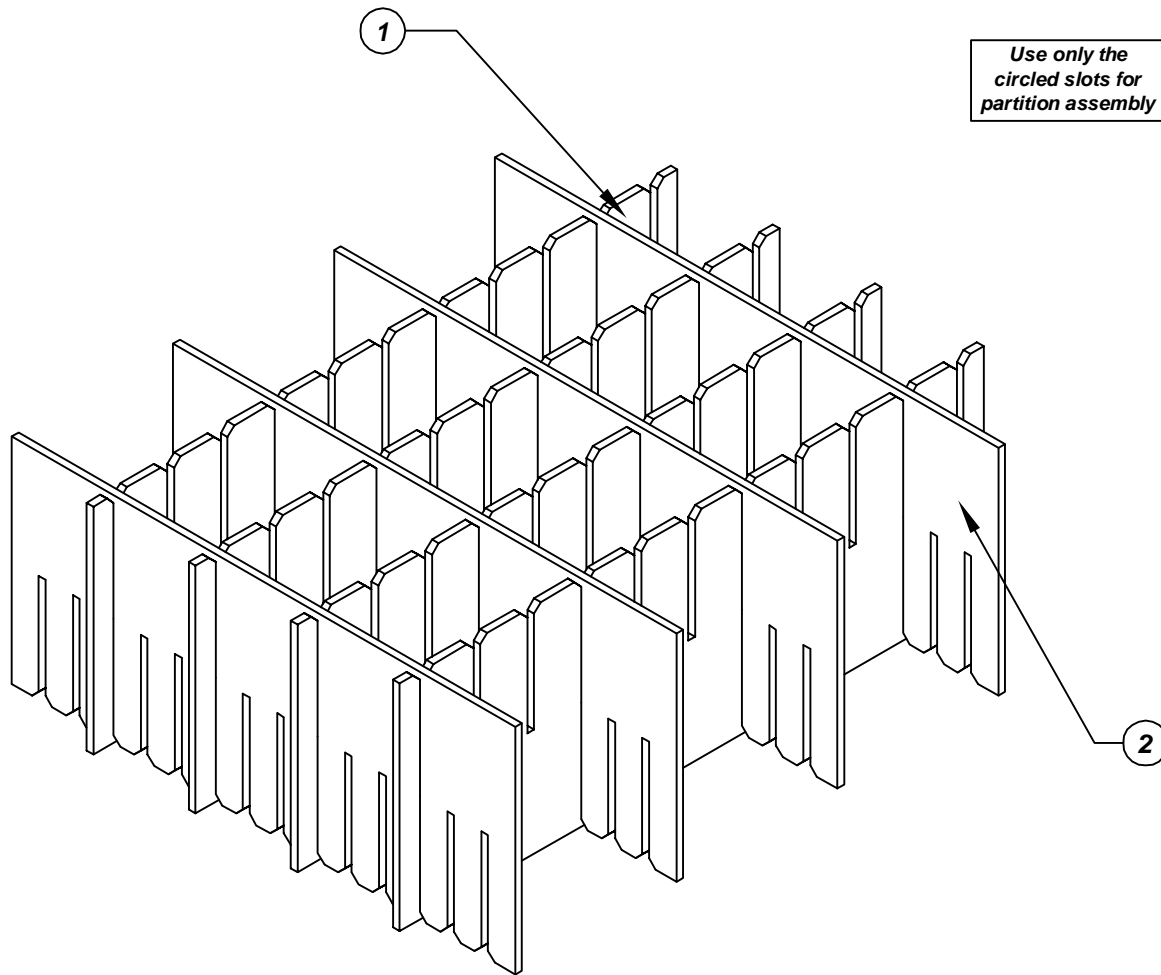

Use only the circled slots for partition assembly

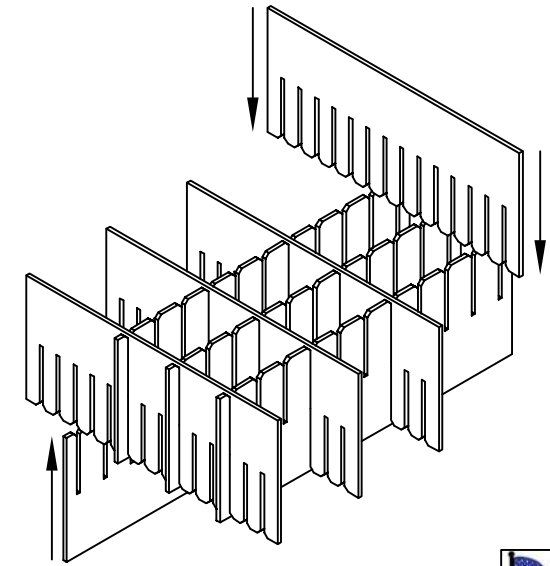
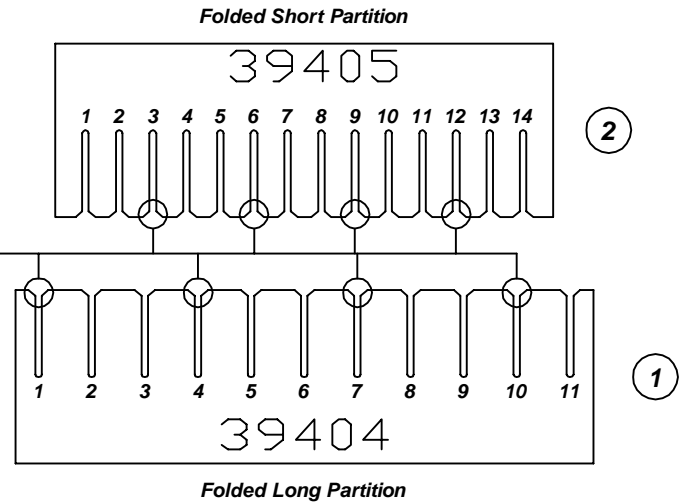

Made in America

F/N ①	Part # <b>39404</b>	Dimensions: <b>16-3/16" x 21-3/4"</b>	Description: <b>Adjustable Long Partition</b>	Qty: <b>4</b>
F/N ②	Part # <b>39405</b>	Dimensions: <b>16-3/16" x 18-3/4"</b>	Description: <b>Adjustable Short Partition</b>	Qty: <b>4</b>

## 38809 - 15 Cell Inplant Handler Cell Size - 8" x 5-3/4" x 3-1/2"

Notes:  
For use with the following storage container & lid:  
37532 - Storage Container  
37557 - Lid

PROTEKTIVE PAK  
13520 MONTE VISTA AVENUE, CHINO, CA 91710  
PHONE (909) 627-2578, FAX (909) 363-7331  
ProtektivePak.com



DRAWING NUMBER  
**IPH-38809**

DATE  
**Dec. 2007**