

1

2

3

4

PRODUCT NUMBER

SEE TABLE

KIT PARTS
SCALE 1.000

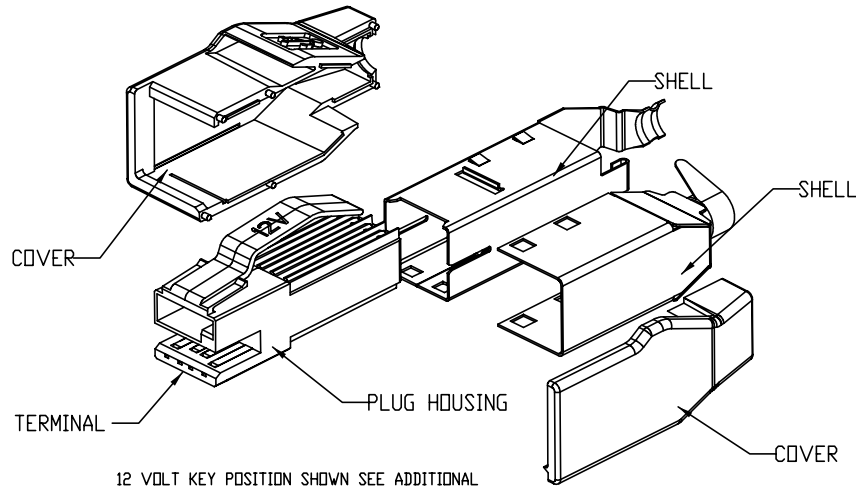

12 VOLT KEY POSITION SHOWN SEE ADDITIONAL SHEETS FOR OTHER KEYING OPTIONS

MATERIALS	SPECIFICATIONS
SHELLS	STAINLESS STEEL
HOUSINGS	THERMOPLASTIC UL94V-0 RATED
TERMINALS	HIGH STRENGTH COPPER ALLOY
COVERS	THERMOPLASTIC UL94V-0 RATED; COLOR: SEE TABLE.
PLATING	
SHELL	UNDERPLATE; 40 MICROINCHES Ni MIN 100 MICROINCHES MIN TIN (TIN/LEAD)
TERMINALS	UNDERPLATE; 40 MICROINCHES Ni CONTACT AREA; 30 MICROINCHES GXT TAIL AREA; 100 MICROINCHES TIN (TIN/LEAD)
ELECTRICAL	
VOLTAGE RATING	USB;5.25VDC,+POWER;12VDC,24VDC,5VDC,48VDC
DIELECTRIC WITHSTANDING VOLTAGE	750 VAC
INSULATION RESISTANCE	1000 MEG OHMS AT 500 VDC
CURRENT RATING (NOTE 1)	1.50A USB SECTION 3.00A POWER SECTION

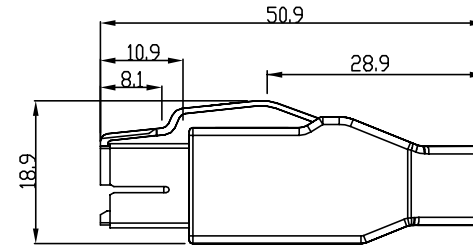
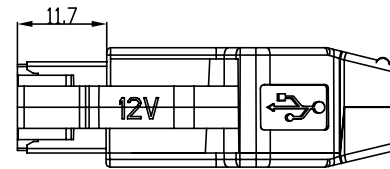

FOR ALL PRODUCT EXCEPT 74233-221LF

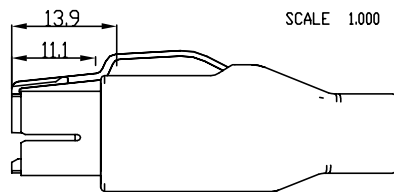
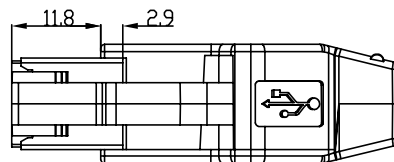
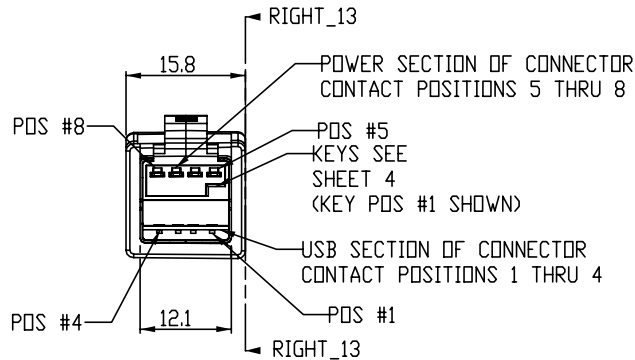

ONLY FOR 74233-221LF

REV F - 2006-04-17

1

2

3

4

PDS: Rev :R

STATUS:Released

Printed: Mar 28, 2012



Copyright FCI.

mat'l code		SEE NOTE		tolerances unless otherwise specified		CUSTOMER		FCI			
ltr	ecn no.	dr	date	linear	.X ± 0.3	COPY		www.fciconnect.com			
J	N04-0069	PH	10/18/2004		.XX ± 0.13	projection		title			
K	N05-0255	PH	09/09/2005		.XXX ± 0.05			USB+ POWER PLUG KIT ASSEMBLY			
L	N08-0122	BS	06/16/2008	angles	0° ± 2°			product family			
M	N09-0123	R.B	04/24/2009	dr	P. HSU	10/6/97	MM		USB		
N	N09-0340	R.B	10/22/2009	engr	R. MACMULLIN	10/6/97	←→		code		
P	EDN-ELX-N-006068	A.ZH	09/20/2011	chr	R.MACMULLIN	10/6/97	scale		size		
R	EDN-ELX-N-010944	A.ZH	03/22/2012	appd	R. MACMULLIN	10/6/97	1:1		dwg no		
sheet		revision	R					A4		74233	sheet
index		sheet	1-3								1 of 3

PRODUCT NUMBER

SEE TABLE

12V KEY POSITION
SCALE 1.500

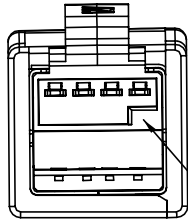

KEY POS. 1

24 KEY POSITION
SCALE 1.500

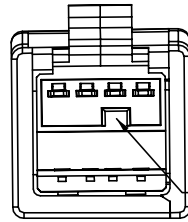

KEY POS. 2

5V KEY POSITION
SCALE 1.500

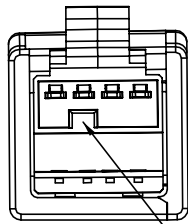

KEY POS. 3

UNASSIGNED KEY
SCALE 1.500

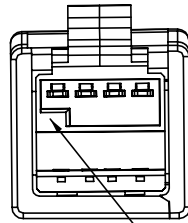

KEY POS. 4

ABOVE ASSEMBLIES ARE SHOWN ONLY FOR
KEY INFORMATION, FOR ASSEMBLY INFORMATION
AND DIMENSIONS SEE PREVIOUS SHEETS

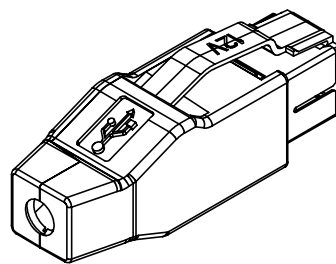
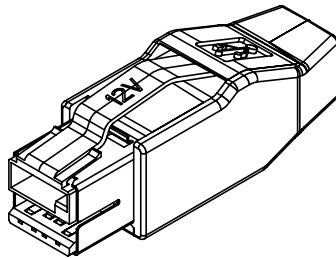

NOTES:

1. CURRENT AS LISTED IS AMPS PER CONTACT WITH ALL CONTACTS POWER;
2. DIMENSIONS AND TOLERANCES ARE IN ACCORDANCE WITH ASME Y14.5M, 1994;
3. MATING SEQUENCE WHEN MATED WITH USB+POWER RECEPTACLE PRODUCT NUMBER 55917-XXX;
4. PRODUCT NUMBER 74233-XXXLF

LEAD FREE OPTION

WITH 'LF' SUFFIX, TERMINAL AND SHELL PLATING IS TIN,
WITHOUT 'LF' SUFFIX, TERMINAL AND SHELL PLATING IS TIN/LEAD;

5. PRODUCT SPECIFICATION REFERS TO GS-12-130;
6. PACKAGE SPECIFICATION REFERS TO GS-14-395;
7. PACKING STANDARD GS-14-920 WILL BE APPLIED FOR LEAD FREE P/N'S;
8. FOR LEAD FREE PART NUMBER, THE PRODUCT MEET EUROPEAN UNION DIRECTIVES AND OTHER COUNTRY REGULATION AS DESCRIBED IN GS-22-008;
9. FOR LEAD FREE PART NUMBERS, THE HOUSING WILL WITHSTAND EXPOSURE TO 260°C PEAK TEMPERATURE FOR 40 SECONDS IN A CONVECTION, INFRO-RED OR VAPOR PHASE REFLOW OVEN;
10. INSULATION MYLAR MUST COVER WITH ALL TERMINALS AND SOLDERED POINTS ON BOTH TWO SIDES (ONE PIECE EACH SIDE) AFTER SOLDERING AND BEFORE ASSEMBLE SHIELDS, RECOMMENDED DIMENSION OF MYLAR IS 27.00±0.10*10.00*±0.10*0.10±0.03 (LENGTH*WIDTH*THICKNESS), AND IT MUST BE OF HIGH TEMPERATURE RESISTANCE. PLEASE REFER TO THE THE APPLICATION SPEC AS GS-20-043.

CONTACT NUMBER	PRODUCT DASH NUMBER			
	-1XX(X)	-2XX(X)	-3XX(X)	MATING SEQ.
1	VCC	VCC	VCC	2
2	- DATA	- DATA	- DATA	3
3	+ DATA	+ DATA	+ DATA	3
4	GROUND	GROUND	GROUND	2
5	12V GROUND	24V GROUND	5V GROUND	2
6	12V	24V	5V	3
7	12V	24V	5V	3
8	12V GROUND	24V GROUND	5V GROUND	2
SHELL	SHIELD	SHIELD	SHIELD	1

mat'l code		SEE NOTE		tolerances unless otherwise specified		CUSTOMER		 www.fciconnect.com				
ltr	ecn no.	dr	date	linear	.X ± 0.3		COPY	projection	title			
R					.XX ± 0.13							
				angles	.XXX ± 0.05				USB+ POWER PLUG KIT ASSEMBLY			
					0° ± 2°							
				dr	P. HSU	10/6/97	 MM	 scale	product family	USB	code	
				enrg	R. MACMULLIN	10/6/97			size	dwg no		
				chr	R. MACMULLIN	10/6/97			A4	74233		
				appd	R. MACMULLIN	10/6/97			1:1			
sheet	revision											
index	sheet										sheet 2 of 3	

A

B

C

D

A

B

C

D

PRODUCT NUMBER (NOTE 4)	DESCRIPTION	VOLTAGE	PLUG HOUSING COLOR	CABLE OD	CURRENT RATING	COVER COLOR	REMARK
74233-100	KEY POSITION 1	12V	TEAL	5.80±0.25	3 AMPS	GRAY	NON LEAD FREE PART, NOT AVAILABLE
74233-100LF	KEY POSITION 1	12V	TEAL	5.80±0.25	3 AMPS	GRAY	LEAD FREE PART, SUBSTITUTE OF 74233-100
74233-1009LF	KEY POSITION 1	12V	TEAL	5.80±0.25	3 AMPS	BLACK	
74233-101	KEY POSITION 1	12V	TEAL	5.10±0.25	3 AMPS	GRAY	NON LEAD FREE PART, NOT AVAILABLE
74233-101LF	KEY POSITION 1	12V	TEAL	5.10±0.25	3 AMPS	GRAY	LEAD FREE PART, SUBSTITUTE OF 74233-101
74233-1019LF	KEY POSITION 1	12V	TEAL	5.10±0.25	3 AMPS	BLACK	
74233-102	KEY POSITION 1	12V	TEAL	6.60±0.25	3 AMPS	GRAY	NON LEAD FREE PART, NOT AVAILABLE
74233-102LF	KEY POSITION 1	12V	TEAL	6.60±0.25	3 AMPS	GRAY	LEAD FREE PART, SUBSTITUTE OF 74233-102
74233-1029LF	KEY POSITION 1	12V	TEAL	6.60±0.25	3 AMPS	BLACK	
74233-200	KEY POSITION 2	24V	RED	5.80±0.25	3 AMPS	GRAY	NON LEAD FREE PART, NOT AVAILABLE
74233-200LF	KEY POSITION 2	24V	RED	5.80±0.25	3 AMPS	GRAY	LEAD FREE PART, SUBSTITUTE OF 74233-200
74233-2009LF	KEY POSITION 2	24V	RED	5.80±0.25	3 AMPS	BLACK	
74233-201	KEY POSITION 2	24V	RED	5.10±0.25	3 AMPS	GRAY	NON LEAD FREE PART, NOT AVAILABLE
74233-201LF	KEY POSITION 2	24V	RED	5.10±0.25	3 AMPS	GRAY	LEAD FREE PART, SUBSTITUTE OF 74233-201
74233-2019LF	KEY POSITION 2	24V	RED	5.10±0.25	3 AMPS	BLACK	
74233-211	KEY POSITION 2	48V	RED	5.10±0.25	3 AMPS	GRAY	NON LEAD FREE PART, NOT AVAILABLE
74233-211LF	KEY POSITION 2	48V	RED	5.10±0.25	3 AMPS	GRAY	LEAD FREE PART, SUBSTITUTE OF 74233-211
74233-2119LF	KEY POSITION 2	48V	RED	5.10±0.25	3 AMPS	BLACK	
74233-221LF	KEY POSITION 2	48V	RED	5.10±0.25	3 AMPS	GRAY	SPECIAL PART, LATCH BACKWARD 3mm BASE ON 74233-211LF
74233-202	KEY POSITION 2	24V	RED	6.60±0.25	3 AMPS	GRAY	NON LEAD FREE PART, NOT AVAILABLE
74233-202LF	KEY POSITION 2	24V	RED	6.60±0.25	3 AMPS	GRAY	LEAD FREE PART, SUBSTITUTE OF 74233-202
74233-2029LF	KEY POSITION 2	24V	RED	6.60±0.25	3 AMPS	BLACK	
74233-300	KEY POSITION 3	5V	NATURAL	5.80±0.25	3 AMPS	GRAY	NON LEAD FREE PART, NOT AVAILABLE
74233-300LF	KEY POSITION 3	5V	NATURAL	5.80±0.25	3 AMPS	GRAY	LEAD FREE PART, SUBSTITUTE OF 74233-300
74233-3009LF	KEY POSITION 3	5V	NATURAL	5.80±0.25	3 AMPS	BLACK	
74233-301	KEY POSITION 3	5V	NATURAL	5.10±0.25	3 AMPS	GRAY	NON LEAD FREE PART, NOT AVAILABLE
74233-301LF	KEY POSITION 3	5V	NATURAL	5.10±0.25	3 AMPS	GRAY	LEAD FREE PART, SUBSTITUTE OF 74233-301
74233-3019LF	KEY POSITION 3	5V	NATURAL	5.10±0.25	3 AMPS	BLACK	
74233-302	KEY POSITION 3	5V	NATURAL	6.60±0.25	3 AMPS	GRAY	NON LEAD FREE PART, NOT AVAILABLE
74233-302LF	KEY POSITION 3	5V	NATURAL	6.60±0.25	3 AMPS	GRAY	LEAD FREE PART, SUBSTITUTE OF 74233-302
74233-3029LF	KEY POSITION 3	5V	NATURAL	6.60±0.25	3 AMPS	BLACK	



Copyright FCI.

mat'l code				SEE NOTE		tolerances unless otherwise specified		CUSTOMER		 www.fciconnect.com	
ltr	ecn no.	dr	date	linear	.X ± 0.3		COPY		 title USB+ POWER PLUG KIT ASSEMBLY		
R					.XX ± 0.13		projection				
					.XXX ±0.05		 product family USB code				
				angles	0° ±2°		 MM		size		
				dr	P. HSU	10/6/97	 1:1		dwg no		
				engr	R. MACMULLIN	10/6/97			74233		
				chr	R.MACMULLIN	10/6/97			sheet		
				appd	R. MACMULLIN	10/6/97			3 of 3		
sheet	revision										
index	sheet										