

6

5

4

3

2

1

APPROVED: \_\_\_\_\_

DATE: \_\_\_\_\_ TITLE: \_\_\_\_\_

Rev	AWO #	Description	Date	Appr
-		RELEASED	9/26/08	
A		UPDATE SPEC.	2/15/16	AY/MY

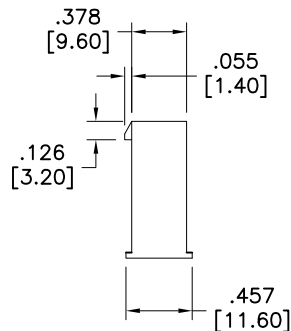
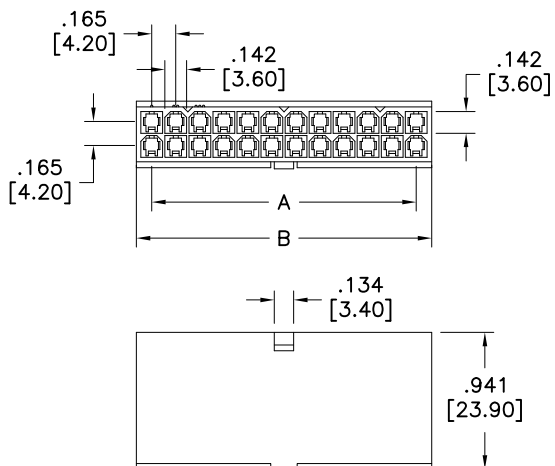

2 POSITION



8 POSITION



4 POSITION



10 POSITION

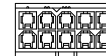

6 POSITION



12 POSITION

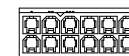

14 POSITION

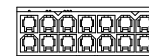

20 POSITION

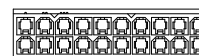

16 POSITION

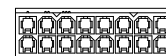

22 POSITION

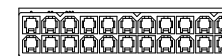

18 POSITION



24 POSITION

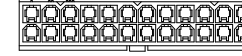

Wire Size AWG	Positions			
	2	4, 6	8, 10	12~24
#18	9A	8A	7A	6A
#20	7A	6A	5A	5A
#22	5A	4A	4A	4A
#24	4A	3A	3A	3A

SPECIFICATIONS:

Material:

Insulator: Nylon 66, rated UL 94V-2

Insulator color: Natural

Electrical:

Operating voltage: 600 VAC max

Current rating: See chart

Insulation resistance: 1000 Mohms min @ 500 VDC

Dielectric withstanding voltage: 1500 VAC for 1 minute

Mechanical:

Wire size: 18 Awg thru 24 Awg

Temperature Rating:

Operating temperature: -40°C to 105°C

Environmental:

Lead free, RoHS compliant.



Positions: 2 thru 24

A = .165 [4.20] X No. of Spaces per row

B = .165 [4.20] X No. of Positions per row + .047 [1.20]

UNLESS OTHERWISE SPECIFIED  
 ALL DIMENSIONS ARE MM [INCHES]  
 TOLERANCES: EXCEPT AS NOTED

INCHES		HOLES	
.X ± .10	∅X ± .10		
.XX ± .020	∅XX ± .015		
.XXX ± .015	∅XXX ± .010		

**ADAM TECH**

909 Rahway Avenue, Union, NJ 07083  
Phone: 908-687-5000 Fax: 908-687-5710

APPROVALS		DATE
DRAWN	DY	9/26/08
CHECKED		
APPROVED		

TITLE PLUG HOUSING, DUAL ROW, .165 [4.20] PITCH WITHOUT MOUNTING EARS		
SIZE X	PART NO. DMF-XX-W-NE	REV. A
REF: S00123T	SCALE: NTS	SHEET 1 OF 1

6

5

4

3

2

1