

Click to  
**ORDER**  
samples

**AMFE30503**



Encapsulated

Aimtec's AMFE30503 series is designed to offer protection against AC power surges. These filters can assist the AC-DC converters in meeting the Surge level of IEC/EN61000-4-5 standard  $\pm 1KV$  ( $2\Omega$  internal resistance) or  $\pm 2KV$  ( $12\Omega$  internal resistance) and EMI requirement of CISPR22/EN55022 Class B standard.

With a wide input voltage range of 85-305 VAC in a compact package these filter modules are best suited for AC-DC application that are sensitive to noise interference.

**Features**



- Universal Input: 85 - 305VAC
- Operating Temp:  $-40^{\circ}C$  to  $+85^{\circ}C$
- High isolation voltage: 2000VAC
- Surge Suppression: L-N:  $\pm 1KV$ , L-G:  $\pm 2KV$
- EMI Meet EN55032 Class B

**Summary**

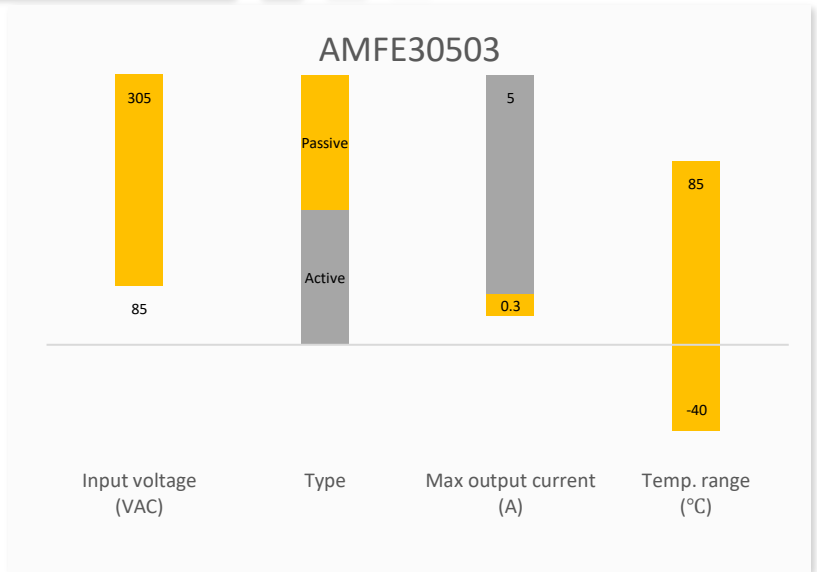

**Training**

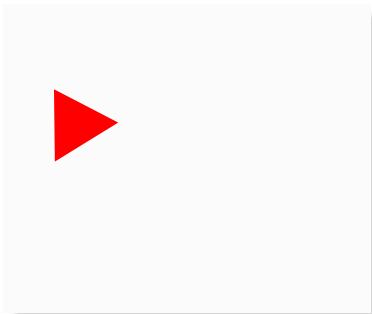

Product Training Video  
(click to open)

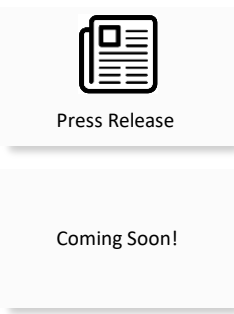

Application Notes

**Applications**



Power Grid



Industrial



Telecom



Instrumentation

## Models & Specifications

### Models

Model	Input Voltage (VAC)	Max Current (A)
AMFE30503-LN11	85 - 305	0.3

### General Specifications

Parameters	Conditions	Typical	Maximum	Units
Operating temperature		-40 to +85		°C
Storage temperature		-40 to +105		°C
Case temperature rise	220VAC / 0.3A		5	°C
Isolation Voltage (L/GND ; N/GND)	1 min, 1mA leakage current	2000		VAC
Case material	Heat resistant black Plastic (flammability to UL 94V-0)			
Weight		20		g
Dimensions (L x W x H)		1.33 x 0.87 x 0.71 inches (33.70 x 22.20 x 18.00mm)		

NOTE: All specifications in this datasheet are measured at an ambient temperature of 25°C, humidity < 75%, nominal input voltage and at rated output load unless otherwise specified.

### Safety Specifications

#### Parameters

#### Standards

Put AMFE30503-LN11 on to the input of AC/DC module can ensure the module meet Surge level of IEC/EN61000-4-5 standard  $\pm 1\text{KV}$  ( $2\Omega$  internal resistance) /  $\pm 2\text{KV}$  ( $12\Omega$  internal resistance) and EMI requirement of CISPR32/EN55032 Class B.

## Dimensions

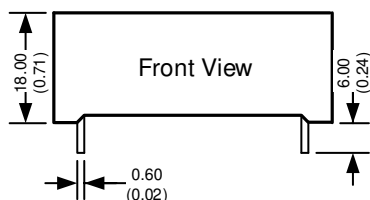
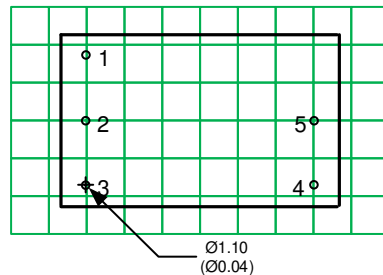
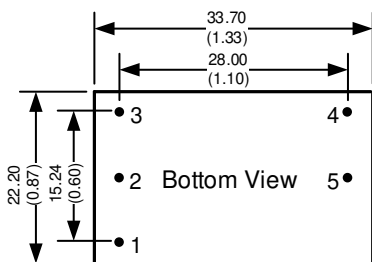

Dimensions mm (inch).  
Pin diameter tolerance  $\pm 0.1$  ( $\pm 0.004$ )  
Pin height tolerance  $\pm 0.5$  ( $\pm 0.02$ )

### Pin Output Specifications

Pin	Single
1	GND
2	Input (N)
3	Input (L)
4	Output (L)
5	Output (N)

## Application Circuit

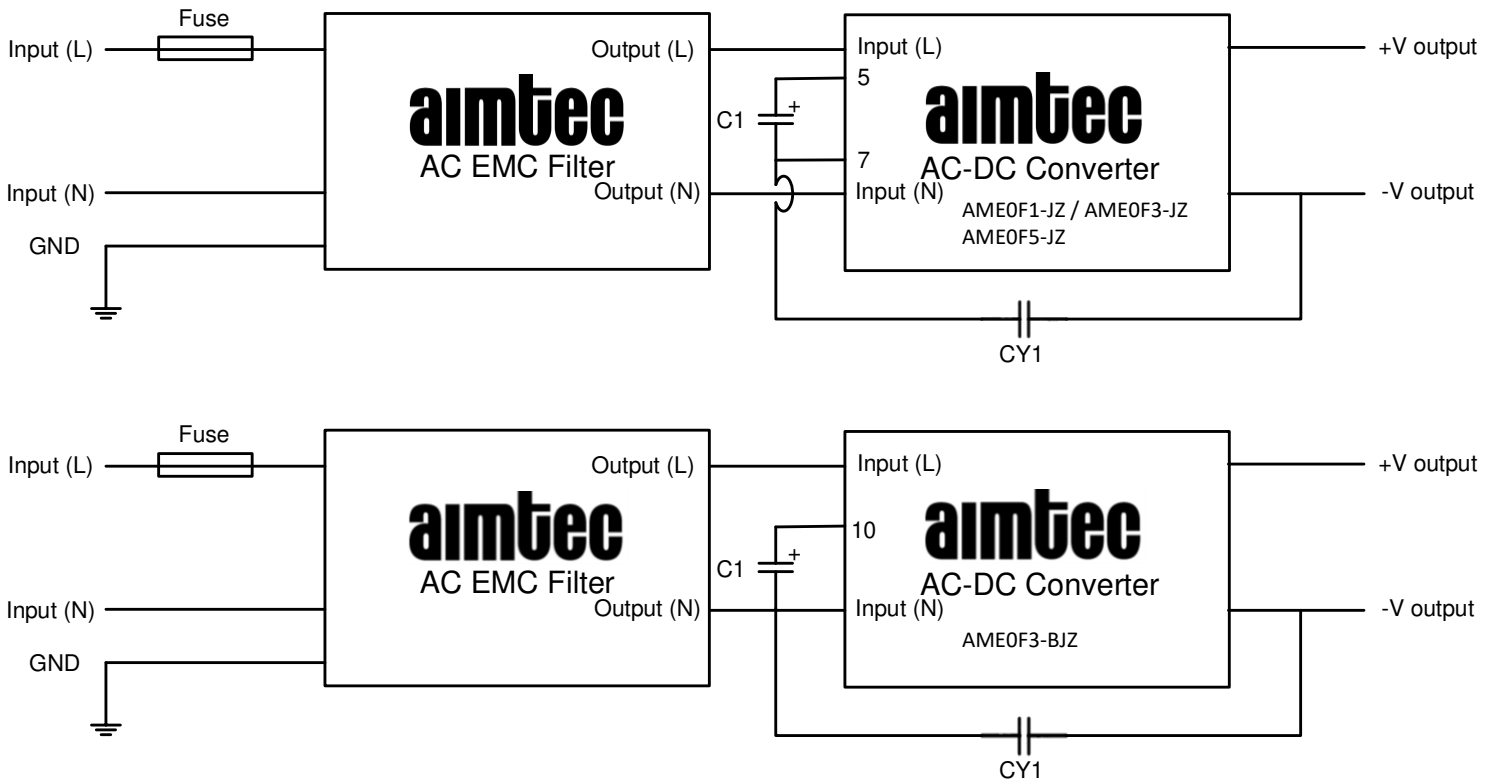

Model	Recommended external circuit parameters
Fuse	Due to the different of the power module input current, the fuse of the recommended values, please refer to the technical manual for the power module.
C1 / CY1	Parameter selection please refer to power supply technical manual.

## Supporting the power module product model

Model	EMI (Without External Circuit)	EMI (With AMEF30503-LN11)	EFT (Without External Circuit)	EFT (With AMEF30503-LN11)	Surge (Without External Circuit)	Surge (With AMEF30503-LN11)
AME0F1-JZ AME0F3-BJZ AME0F3-JZ AME0F5-JZ		CISPR32/EN55032 CLASS B		IEC/EN61000-4-4 ± 4KV Perf. Criteria B		IEC/EN61000-4-5 ± 1KV / ± 2KV Perf. Criteria B

**NOTE:** 1. Datasheets are updated as needed and as such, specifications are subject to change without notice. Once printed or downloaded, datasheets are no longer controlled by Aimtec; refer to [www.aimtec.com](http://www.aimtec.com) for the most current product specifications. 2. Product labels shown, including safety agency certifications on labels, may vary based on the date manufactured. 3. Mechanical drawings and specifications are for reference only. 4. All specifications are measured at an ambient temperature of 25°C, humidity<75%, nominal input voltage and at rated output load unless otherwise specified. 5. Aimtec may not have conducted destructive testing or chemical analysis on all internal components and chemicals at the time of publishing this document. CAS numbers and other limited information are considered proprietary and may not be available for release. 6. This product is not designed for use in critical life support systems, equipment used in hazardous environments, nuclear control systems or other such applications which necessitate specific safety and regulatory standards other the ones listed in this datasheet. 7. Warranty is in accordance with Aimtec's standard Terms of Sale available at [www.aimtec.com](http://www.aimtec.com).