

## STRADA-SQ-FT

Forward throw beam for area lighting. Assembly with installation tape. Version with location pins.

### SPECIFICATION:

Dimensions	25.0 x 25.0 mm
Height	12.7 mm
Fastening	pin, screw, tape
ROHS compliant	yes ⓘ

### MATERIALS:

Component	Type	Material	Colour	Finish
STRADA-SQ-FT	Single lens	PMMA	clear	
ROSE-TAPE	Tape	Acrylic foam	black	

### ORDERING INFORMATION:

Component	Type	Qty in box	MOQ	MPQ	Box weight (kg)
CA13752_STRADA-SQ-FT » Box size: 480 x 280 x 300 mm	Single lens	1568	294	98	7.2



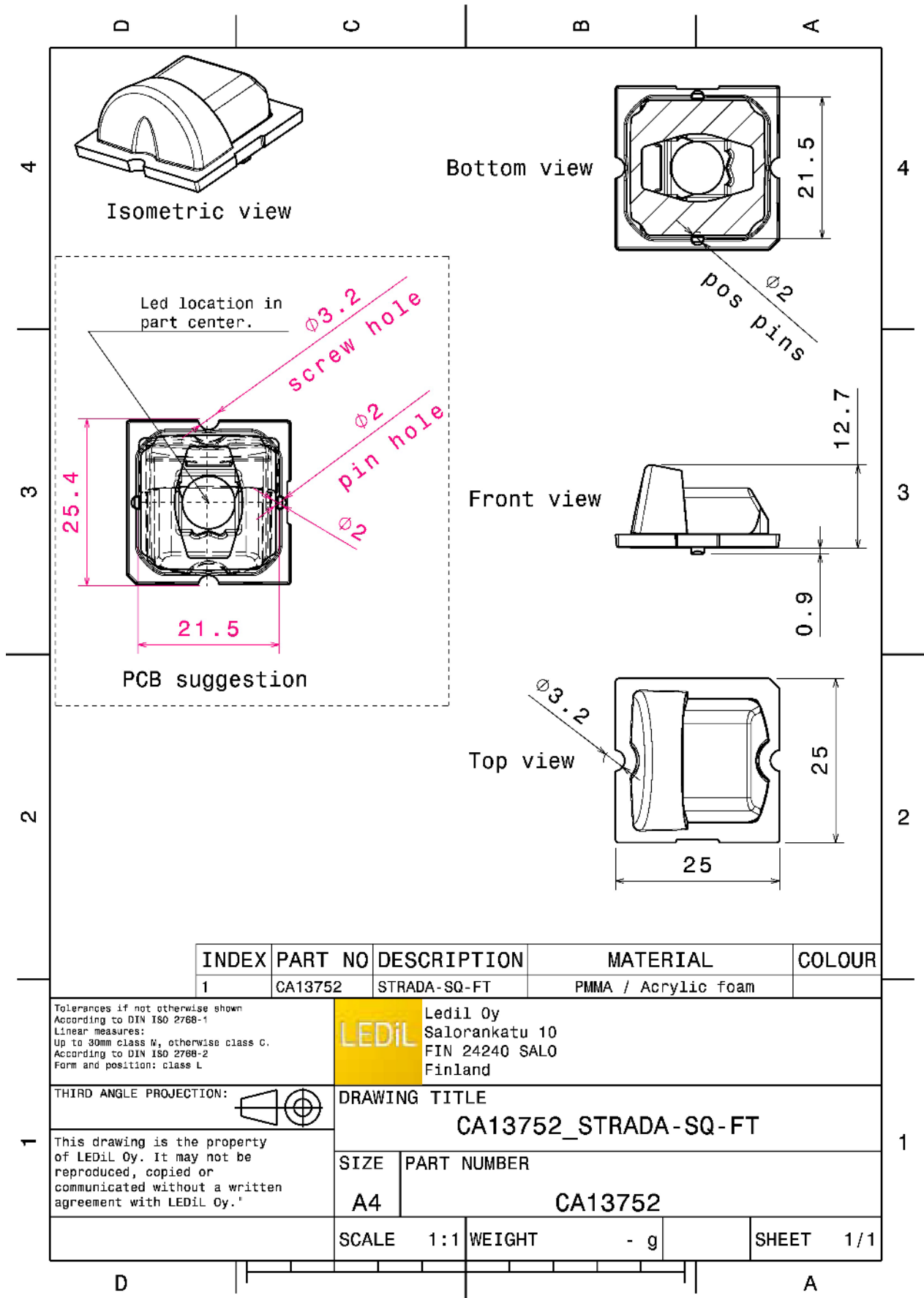

INDEX	PART NO	DESCRIPTION	MATERIAL	COLOUR
1	CA13752	STRADA-SQ-FT	PMMA / Acrylic foam	

Tolerances if not otherwise shown  
According to DIN ISO 2768-1  
Linear measures:  
Up to 30mm class M, otherwise class C.  
According to DIN ISO 2768-2  
Form and position: class L



Ledil Oy  
Salorankatu 10  
FIN 24240 SALO  
Finland

THIRD ANGLE PROJECTION:



DRAWING TITLE  
**CA13752\_STRADA-SQ-FT**

This drawing is the property of LEDiL Oy. It may not be reproduced, copied or communicated without a written agreement with LEDiL Oy.

SIZE	PART NUMBER
A4	CA13752

SCALE	1:1	WEIGHT	- g	SHEET	1/1
-------	-----	--------	-----	-------	-----

See also our general installation guide: [www.ledil.com/installation\\_guide](http://www.ledil.com/installation_guide)

#### OPTICAL RESULTS (MEASURED):

##### CREE LED

LED MK-R  
 FWHM / FWTM Asymmetric  
 Efficiency 89 %  
 Peak intensity 0.6 cd/lm  
 LEDs/each optic 1  
 Light colour White  
 Required components:

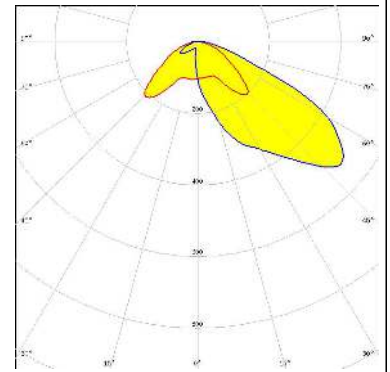

##### CREE LED

LED XHP50  
 FWHM / FWTM Asymmetric  
 Efficiency 90 %  
 Peak intensity 0.6 cd/lm  
 LEDs/each optic 1  
 Light colour White  
 Required components:

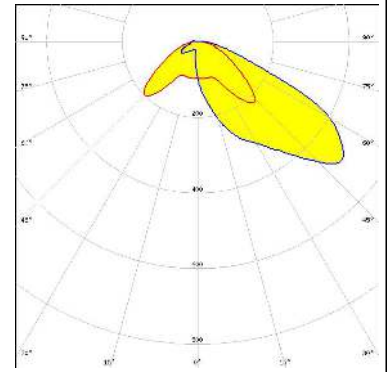

##### CREE LED

LED XM-L  
 FWHM / FWTM Asymmetric  
 Efficiency 90 %  
 Peak intensity 0.7 cd/lm  
 LEDs/each optic 1  
 Light colour White  
 Required components:

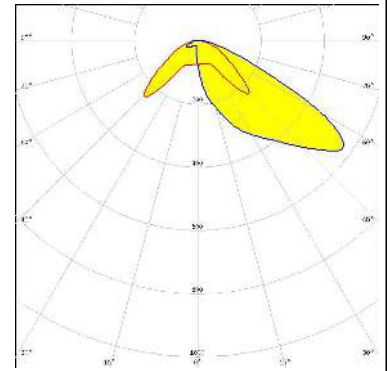

##### CREE LED

LED XP-L HD  
 FWHM / FWTM Asymmetric  
 Efficiency 91 %  
 Peak intensity 0.7 cd/lm  
 LEDs/each optic 1  
 Light colour White  
 Required components:

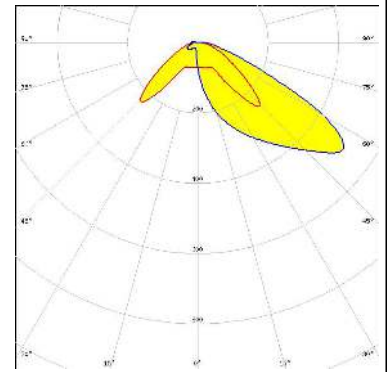

### OPTICAL RESULTS (MEASURED):

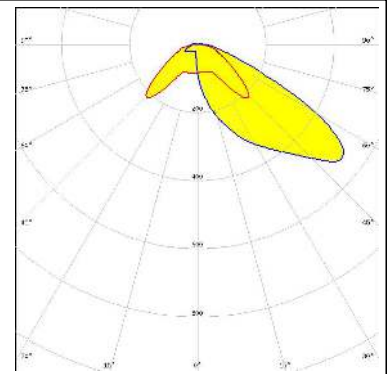
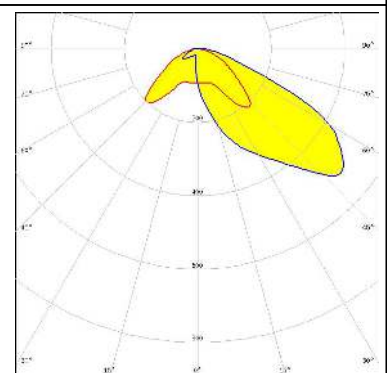
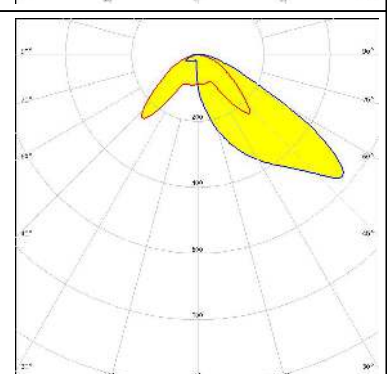
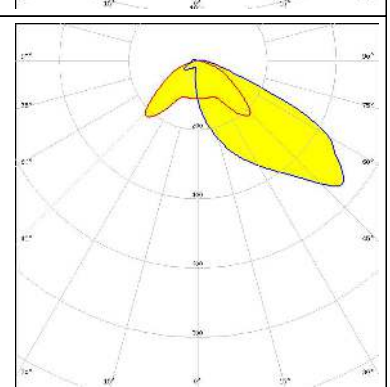
<p><b>CREE</b> → <b>LED</b></p> <p>LED: XP-L2            FWHM / FWTM: Asymmetric            Efficiency: 90 %            Peak intensity: 0.7 cd/lm            LEDs/each optic: 1            Light colour: White            Required components:</p>	
<p><b>LUMILEDS</b></p> <p>LED: LUXEON M/MX            FWHM / FWTM: Asymmetric            Efficiency: 88 %            Peak intensity: 0.6 cd/lm            LEDs/each optic: 1            Light colour: White            Required components:</p>	
<p><b>LUMILEDS</b></p> <p>LED: LUXEON MZ            FWHM / FWTM: Asymmetric            Efficiency: 90 %            Peak intensity: 0.7 cd/lm            LEDs/each optic: 1            Light colour: White            Required components:</p>	
<p><b>LUMILEDS</b></p> <p>LED: LUXEON XR-M Linear (L2M0-xxxx003MC3300)            FWHM / FWTM: Asymmetric            Efficiency: 92 %            Peak intensity: 0.7 cd/lm            LEDs/each optic: 1            Light colour: White            Required components:</p>	

### OPTICAL RESULTS (MEASURED):

<p><b>NICHIA</b></p> <p>LED NVSW319B FWHM / FWTM Asymmetric Efficiency 90 % Peak intensity 0.7 cd/lm LEDs/each optic 1 Light colour White Required components:</p>	
<p><b>OSRAM</b> Opto Semiconductors</p> <p>LED Duris S10 FWHM / FWTM Asymmetric Efficiency 89 % Peak intensity 0.6 cd/lm LEDs/each optic 1 Light colour White Required components:</p>	

### OPTICAL RESULTS (SIMULATED):

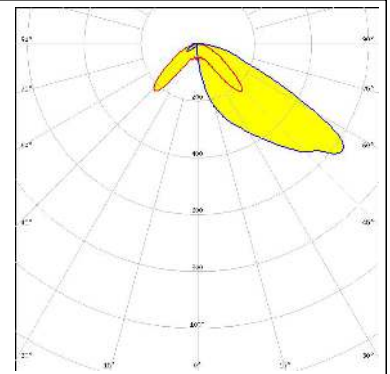
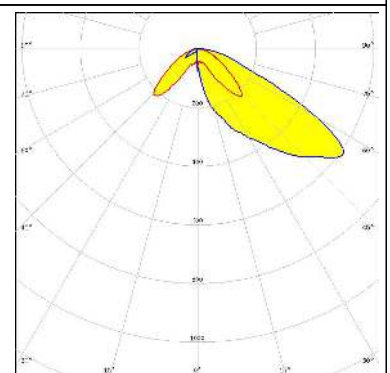
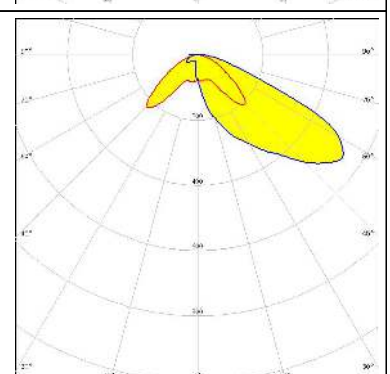
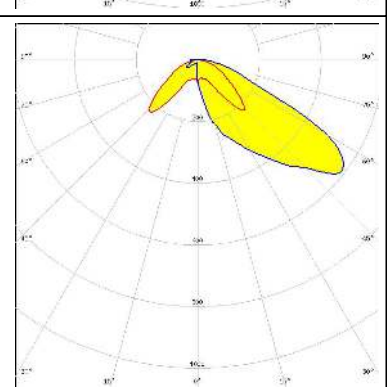
<p><b>CREE ⇄ LED</b></p> <p>LED: MX-3            FWHM / FWTM: Asymmetric            Efficiency: 90 %            LEDs/each optic: 1            Light colour: White            Required components:</p>	
<p><b>CREE ⇄ LED</b></p> <p>LED: MX-6            FWHM / FWTM: Asymmetric            Efficiency: 90 %            LEDs/each optic: 1            Light colour: White            Required components:</p>	
<p><b>CREE ⇄ LED</b></p> <p>LED: XHP50.3 HD            FWHM / FWTM: Asymmetric            Efficiency: 90 %            Peak intensity: 0.7 cd/lm            LEDs/each optic: 1            Light colour: White            Required components:</p>	
<p><b>CREE ⇄ LED</b></p> <p>LED: XHP50.3 HI            FWHM / FWTM: Asymmetric            Efficiency: 92 %            Peak intensity: 0.7 cd/lm            LEDs/each optic: 1            Light colour: White            Required components:</p>	

#### OPTICAL RESULTS (SIMULATED):

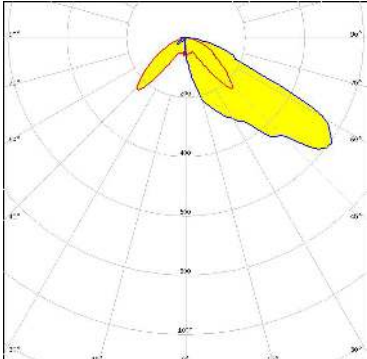
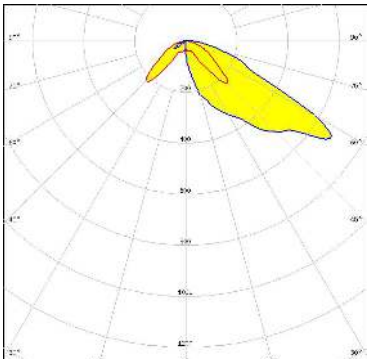
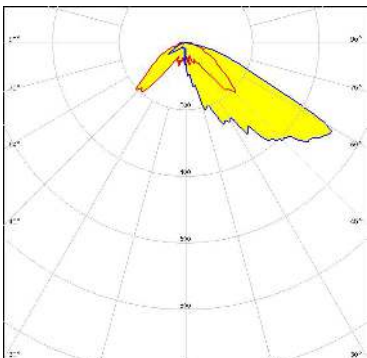
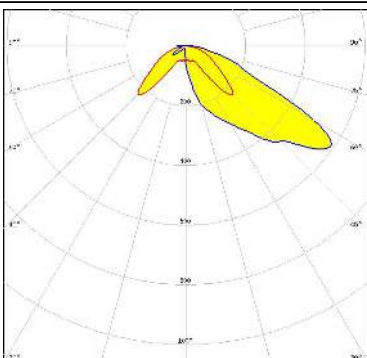
<p><b>CREE</b> ⇄ <b>LED</b></p> <p>LED XM-L2            FWHM / FWTM Asymmetric            Efficiency 90 %            LEDs/each optic 1            Light colour White            Required components:</p>	
<p><b>CREE</b> ⇄ <b>LED</b></p> <p>LED XP-G2            FWHM / FWTM Asymmetric            Efficiency 89 %            LEDs/each optic 1            Light colour White            Required components:</p>	
<p><b>CREE</b> ⇄ <b>LED</b></p> <p>LED XP-G3            FWHM / FWTM Asymmetric            Efficiency 76 %            Peak intensity 0.7 cd/lm            LEDs/each optic 1            Light colour White            Required components:</p> <p style="background-color: #ADD8E6; padding: 2px;">Protective plate, glass</p>	
<p><b>CREE</b> ⇄ <b>LED</b></p> <p>LED XP-G3            FWHM / FWTM Asymmetric            Efficiency 91 %            Peak intensity 0.8 cd/lm            LEDs/each optic 1            Light colour Red            Required components:</p>	

#### OPTICAL RESULTS (SIMULATED):

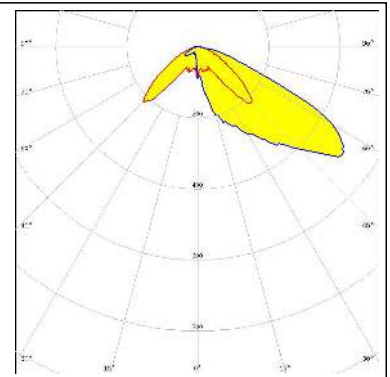
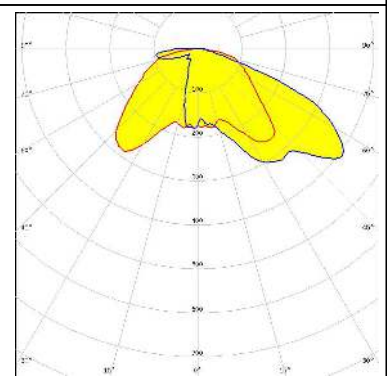
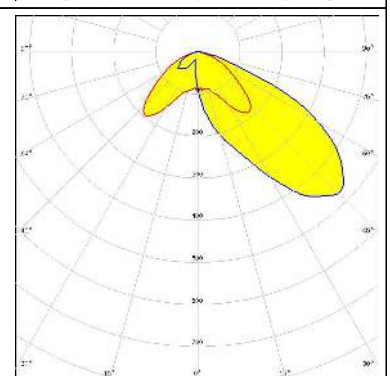
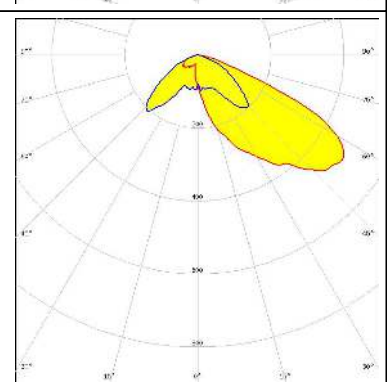
<p><b>CREE</b> LED</p> <p>LED: XP-L2            FWHM / FWTM: Asymmetric            Efficiency: 76 %            Peak intensity: 0.6 cd/lm            LEDs/each optic: 1            Light colour: White</p> <p>Required components:</p> <p>Protective plate, glass</p>	
<p><b>CREE</b> LED</p> <p>LED: XT-E            FWHM / FWTM: Asymmetric            Efficiency: 93 %            Peak intensity: 0.6 cd/lm            LEDs/each optic: 1            Light colour: White</p> <p>Required components:</p>	
<p><b>LUMILEDS</b></p> <p>LED: LUXEON 7070            FWHM / FWTM: Asymmetric            Efficiency: 79 %            Peak intensity: 0.6 cd/lm            LEDs/each optic: 1            Light colour: White</p> <p>Required components:</p> <p>Protective plate, glass</p>	
<p><b>LUMILEDS</b></p> <p>LED: LUXEON M/MX            FWHM / FWTM: Asymmetric            Efficiency: 78 %            Peak intensity: 0.6 cd/lm            LEDs/each optic: 1            Light colour: White</p> <p>Required components:</p> <p>Protective plate, glass</p>	

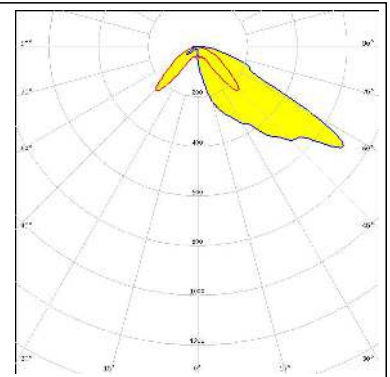
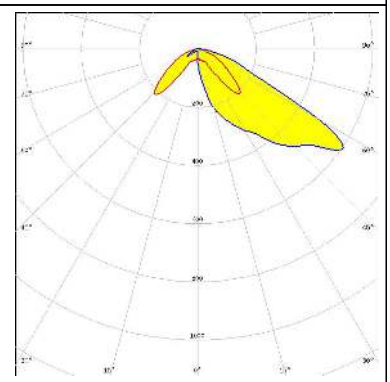
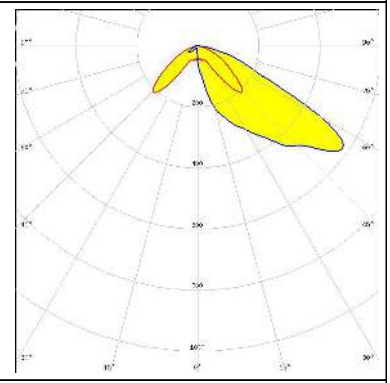
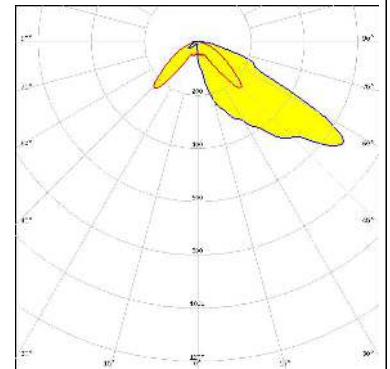

### OPTICAL RESULTS (SIMULATED):

<p><b>LUMINUS</b></p> <p>LED SFT-40-WCS            FWHM / FWTM Asymmetric            Efficiency 93 %            Peak intensity 0.9 cd/lm            LEDs/each optic 1            Light colour White            Required components:</p>	
<p><b>LUMINUS</b></p> <p>LED SFT-40-WCS            FWHM / FWTM Asymmetric            Efficiency 78 %            Peak intensity 0.7 cd/lm            LEDs/each optic 1            Light colour White            Required components:</p> <p>Protective plate, glass</p>	
<p><b>LUMINUS</b></p> <p>LED SFT-70X-WCS            FWHM / FWTM Asymmetric            Efficiency 78 %            Peak intensity 0.7 cd/lm            LEDs/each optic 1            Light colour White            Required components:</p> <p>Protective plate, glass</p>	
<p><b>LUMINUS</b></p> <p>LED SFT-70X-WCS            FWHM / FWTM Asymmetric            Efficiency 93 %            Peak intensity 0.8 cd/lm            LEDs/each optic 1            Light colour White            Required components:</p>	

#### OPTICAL RESULTS (SIMULATED):

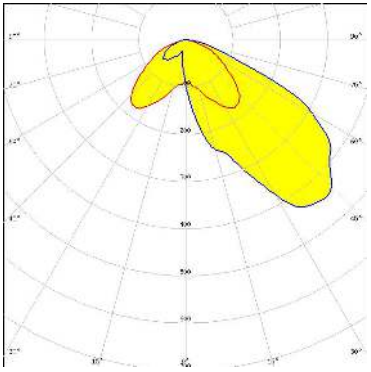
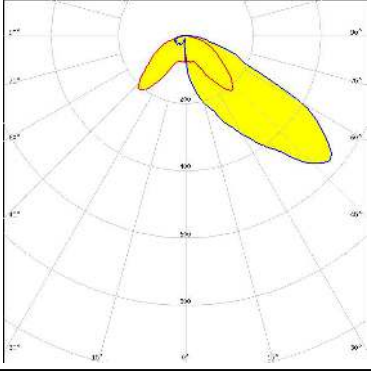
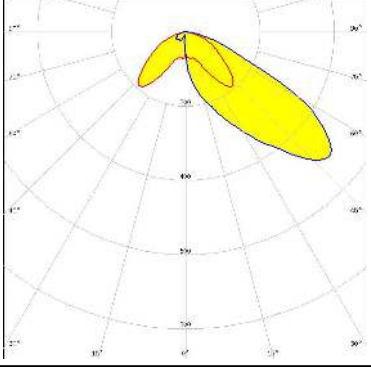
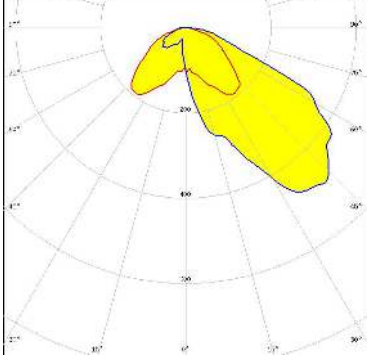
<p><b>NICHIA</b></p> <p>LED NVSxE21A            FWHM / FWTM Asymmetric            Efficiency 78 %            Peak intensity 0.5 cd/lm            LEDs/each optic 9            Light colour White            Required components:</p> <p>Protective plate, glass</p>	
<p><b>NICHIA</b></p> <p>LED NVSxE21A            FWHM / FWTM Asymmetric            Efficiency 93 %            Peak intensity 0.7 cd/lm            LEDs/each optic 4            Light colour White            Required components:</p>	
<p><b>NICHIA</b></p> <p>LED NVSxE21A            FWHM / FWTM Asymmetric            Efficiency 78 %            Peak intensity 0.6 cd/lm            LEDs/each optic 4            Light colour White            Required components:</p> <p>Protective plate, glass</p>	
<p><b>NICHIA</b></p> <p>LED NVSxE21A            FWHM / FWTM Asymmetric            Efficiency 91 %            Peak intensity 0.6 cd/lm            LEDs/each optic 9            Light colour White            Required components:</p>	

#### OPTICAL RESULTS (SIMULATED):

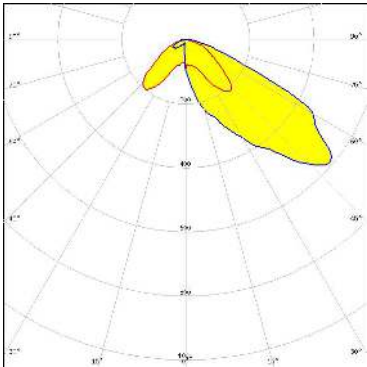
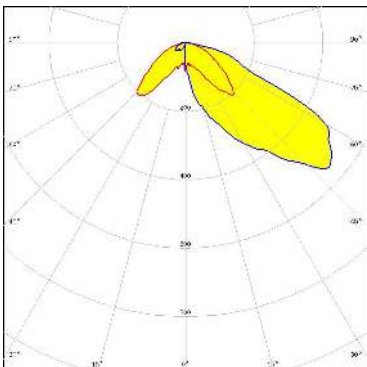
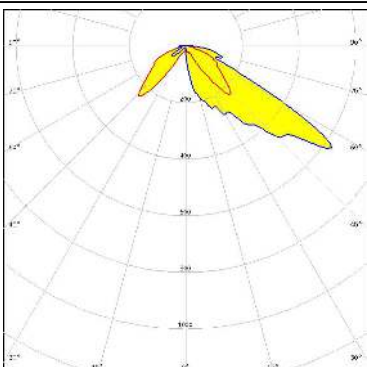
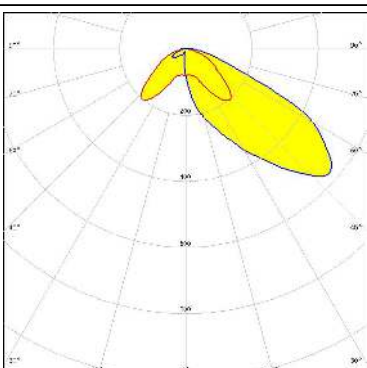
<p><b>OSRAM</b> Opto Semiconductors</p> <p>LED: OSCONIQ C 2424</p> <p>FWHM / FWTM: Asymmetric</p> <p>Efficiency: 92 %</p> <p>Peak intensity: 0.7 cd/lm</p> <p>LEDs/each optic: 4</p> <p>Light colour: White</p> <p>Required components:</p>	
<p><b>OSRAM</b> Opto Semiconductors</p> <p>LED: OSCONIQ P 7070</p> <p>FWHM / FWTM: Asymmetric</p> <p>Efficiency: 89 %</p> <p>Peak intensity: 0.8 cd/lm</p> <p>LEDs/each optic: 1</p> <p>Light colour: White</p> <p>Required components:</p>	
<p><b>OSRAM</b> Opto Semiconductors</p> <p>LED: SFH 4716AS</p> <p>FWHM / FWTM: Asymmetric</p> <p>Efficiency: 92 %</p> <p>LEDs/each optic: 1</p> <p>Light colour: IR</p> <p>Required components:</p>	
<p><b>SAMSUNG</b></p> <p>LED: LH181B</p> <p>FWHM / FWTM: Asymmetric</p> <p>Efficiency: 92 %</p> <p>Peak intensity: 0.7 cd/lm</p> <p>LEDs/each optic: 4</p> <p>Light colour: White</p> <p>Required components:</p>	

### GENERAL INFORMATION:

NOTE: The typical beam angle will be changed by different color, chip size and chip position tolerance. The typical total beam angle is the full angle measured where the luminous intensity is half of the peak value.

### MATERIALS:

As part of our continuous research and improvement processes, and to ensure the best possible quality and availability of our products, LEDiL reserves the right to change material grades without notice.

### PRODUCT DATA USER AGREEMENT AND DISCLAIMER:

The measured data in the provided downloadable LEDiL Product Datasheets and Mechanical 2D-Drawings is rounded and provided as reference for planning. LEDiL Oy's optical specifications have been verified by conducting performance testing of the products in accordance with the company's quality system. The reported data are averaged results of multiple measurements with typical variation. LEDiL Oy reserves the right to without prior notification make changes and improvements to its products.

LEDiL Oy assumes neither warranty, nor guarantee nor any other liability of any kind for the contents and correctness of the provided data. The provided data has been generated with highest diligence but the provided data may in reality not represent the complete possible variation range of all intrinsic parameters. Therefore, in certain cases a deviation from the provided data could occur.

LEDiL Oy reserves the right to undertake technical changes of its products without further notification which could lead to changes in the provided data. LEDiL Oy assumes no liability of any kind for the possible deviation from any provided data or any other damage resulting from the usage of the provided data.

The user agrees to this disclaimer and user agreement with the download or usage of the provided files.

#### LEDiL Oy

Joensuunkatu 13  
FI-24240 SALO  
Finland

#### LEDiL Inc.

228 West Page Street  
Suite D  
Sycamore IL 60178  
USA

#### Ledil Optics Technology (Shenzhen) Co., Ltd.

# 405 , Block B  
Casic Motor Building  
Shenzhen 518057  
P.R.CHINA

#### Local sales and technical support

[www.ledil.com/  
where\\_to\\_buy](http://www.ledil.com/where_to_buy)

#### Shipping locations

Salo, Finland  
Hong Kong, China

#### Distribution Partners

[www.ledil.com/  
where\\_to\\_buy](http://www.ledil.com/where_to_buy)