

AMC1400 Precision, ± 250 -mV Input, Reinforced Isolated Amplifier in a 15-mm Stretched SOIC Package

1 Features

- ± 250 -mV input voltage range optimized for current measurements using shunt resistors
- Fixed gain: 8.2 V/V
- Low DC errors:
 - Offset error: ± 0.2 mV (max)
 - Offset drift: ± 0.9 $\mu\text{V}/^\circ\text{C}$ (max)
 - Gain error: $\pm 0.3\%$ (max)
 - Gain drift: ± 30 ppm/ $^\circ\text{C}$ (max)
 - Nonlinearity: 0.03% (max)
- 3.3-V or 5-V operation on high-side and low-side
- Missing high-side supply detection feature
- High CMTI: 100 kV/ μs (min)
- Low EMI, meets CISPR-11 and CISPR-32 standards
- ≥ 15.7 -mm creepage, stretched SOIC package
- Safety-related certifications:
 - 10600- V_{PK} reinforced isolation per DIN EN IEC 60747-17 (VDE 0884-17)
 - 7500- V_{RMS} isolation for 1 minute per UL1577
- Fully specified over the extended industrial temperature range: -40°C to $+125^\circ\text{C}$

2 Applications

- Shunt-resistor-based current sensing in:
 - [Motor drives](#)
 - [Frequency inverters](#)
 - [Solar inverters](#)
 - [Wind turbine inverters](#)
 - [Rail transport systems](#)

3 Description

The AMC1400 is a precision, isolated amplifier with an output separated from the input circuitry by an isolation barrier that is highly resistant to magnetic interference. This barrier is certified to provide reinforced galvanic isolation of up to 7.5 kV_{RMS} according to DIN EN IEC 60747-17 (VDE 0884-17) and UL1577, and supports a working voltage of up to 2 kV_{RMS}.

The isolation barrier separates parts of the system that operate on different common-mode voltage levels and protects the low-side from voltage levels that can cause electrical damage and are potentially harmful to an operator.

The input of the AMC1400 is optimized for direct connection to a low-impedance shunt resistor or other low-impedance voltage source with low signal levels. The excellent DC accuracy and low temperature drift supports accurate current control in DC/DC converters, frequency inverters, AC motor drives, and other applications that must operate at high voltages, high altitudes, or in environments with high pollution degrees.

The AMC1400 is offered in a stretched SOIC package and is specified over the extended industrial temperature range from -40°C to $+125^\circ\text{C}$.

Package Information⁽¹⁾

PART NUMBER	PACKAGE	BODY SIZE (NOM)
AMC1400	SOIC (8)	6.4 mm × 14.0 mm

- (1) For all available packages, see the orderable addendum at the end of the data sheet.

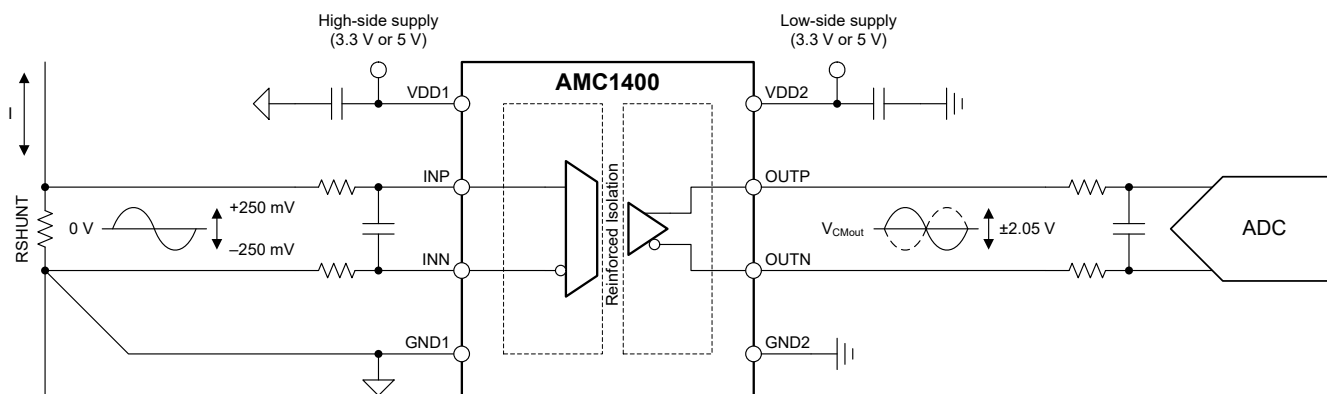

Typical Application



Table of Contents

1 Features	1	7.1 Overview.....	17
2 Applications	1	7.2 Functional Block Diagram.....	17
3 Description	1	7.3 Feature Description.....	17
4 Revision History	2	7.4 Device Functional Modes.....	19
5 Pin Configuration and Functions	3	8 Application and Implementation	20
6 Specifications	4	8.1 Application Information.....	20
6.1 Absolute Maximum Ratings.....	4	8.2 Typical Application.....	20
6.2 ESD Ratings.....	4	8.3 Best Design Practices.....	24
6.3 Recommended Operating Conditions.....	4	8.4 Power Supply Recommendations.....	25
6.4 Thermal Information.....	5	8.5 Layout.....	26
6.5 Power Ratings.....	5	9 Device and Documentation Support	27
6.6 Insulation Specifications.....	6	9.1 Documentation Support.....	27
6.7 Safety-Related Certifications.....	7	9.2 Receiving Notification of Documentation Updates.....	27
6.8 Safety Limiting Values.....	7	9.3 Support Resources.....	27
6.9 Electrical Characteristics.....	8	9.4 Trademarks.....	27
6.10 Switching Characteristics.....	9	9.5 Electrostatic Discharge Caution.....	27
6.11 Timing Diagram.....	9	9.6 Glossary.....	27
6.12 Insulation Characteristics Curves.....	10	10 Mechanical, Packaging, and Orderable Information	27
6.13 Typical Characteristics.....	11	10.1 Mechanical Data.....	28
7 Detailed Description	17		

4 Revision History

NOTE: Page numbers for previous revisions may differ from page numbers in the current version.

DATE	REVISION	NOTES
July 2022	*	Initial Release

5 Pin Configuration and Functions



Figure 5-1. DWL Package, 8-Pin SOIC (Top View)

Table 5-1. Pin Functions

PIN		TYPE	DESCRIPTION
NO.	NAME		
1	VDD1	High-side power	High-side power supply. ⁽¹⁾
2	INP	Analog input	Noninverting analog input. Either INP or INN must have a DC current path to GND1 to define the common-mode input voltage. ⁽²⁾
3	INN	Analog input	Inverting analog input. Either INP or INN must have a DC current path to GND1 to define the common-mode input voltage. ⁽²⁾
4	GND1	High-side ground	High-side analog ground.
5	GND2	Low-side ground	Low-side analog ground.
6	OUTN	Analog output	Inverting analog output.
7	OUTP	Analog output	Noninverting analog output.
8	VDD2	Low-side power	Low-side power supply. ⁽¹⁾

(1) See the [Power Supply Recommendations](#) section for power-supply decoupling recommendations.

(2) See the [Layout](#) section for details.

6 Specifications

6.1 Absolute Maximum Ratings

see⁽¹⁾

		MIN	MAX	UNIT
Power-supply voltage	High-side VDD1 to GND1	-0.3	6.5	V
	Low-side VDD2 to GND2	-0.3	6.5	
Analog input voltage	INP, INN	GND1 – 6	VDD1 + 0.5	V
Output voltage	OUTP, OUTN	GND2 – 0.5	VDD2 + 0.5	V
Input current	Continuous, any pin except power-supply pins	-10	10	mA
Temperature	Junction, T _J		150	°C
	Storage, T _{stg}	-65	150	

- (1) Operation outside the *Absolute Maximum Ratings* may cause permanent device damage. *Absolute Maximum Ratings* do not imply functional operation of the device at these or any other conditions beyond those listed under *Recommended Operating Conditions*. If used outside the Recommended Operating Conditions but within the Absolute Maximum Ratings, the device may not be fully functional, and this may affect device reliability, functionality, performance, and shorten the device lifetime.

6.2 ESD Ratings

			VALUE	UNIT
V _(ESD)	Electrostatic discharge	Human-body model (HBM), per ANSI/ESDA/JEDEC JS-001 ⁽¹⁾	±2000	V
		Charged-device model (CDM), per ANSI/ESDA/JEDEC JS-002 ⁽²⁾	±1000	

- (1) JEDEC document JEP155 states that 500-V HBM allows safe manufacturing with a standard ESD control process.
 (2) JEDEC document JEP157 states that 250-V CDM allows safe manufacturing with a standard ESD control process.

6.3 Recommended Operating Conditions

over operating ambient temperature range (unless otherwise noted)

				MIN	NOM	MAX	UNIT
POWER SUPPLY							
	High-side power supply	VDD1 to GND1		3	5	5.5	V
	Low-side power supply	VDD2 to GND2		3	3.3	5.5	V
ANALOG INPUT							
V _{Clipping}	Differential input voltage before clipping output	V _{IN} = V _{INP} – V _{INN}			±320		mV
V _{FSR}	Specified linear differential full-scale voltage	V _{IN} = V _{INP} – V _{INN}		-250		250	mV
V _{CM}	Operating common-mode input voltage	(V _{INP} + V _{INN}) / 2 to GND1		-0.16		VDD1 – 2.1	V
ANALOG OUTPUT							
C _{LOAD}	Capacitive load	On OUTP or OUTN to GND2				500	pF
C _{LOAD}	Capacitive load	OUTP to OUTN				250	pF
R _{LOAD}	Resistive load	On OUTP or OUTN to GND2			10	1	kΩ
TEMPERATURE RANGE							
T _A	Specified ambient temperature			-40	25	125	°C

6.4 Thermal Information

THERMAL METRIC ⁽¹⁾		DWL (SOIC)	UNIT
		8 PINS	
R _{θJA}	Junction-to-ambient thermal resistance	63.2	°C/W
R _{θJC(top)}	Junction-to-case (top) thermal resistance	26.1	°C/W
R _{θJB}	Junction-to-board thermal resistance	28.5	°C/W
Ψ _{JT}	Junction-to-top characterization parameter	7.8	°C/W
Ψ _{JB}	Junction-to-board characterization parameter	26.8	°C/W
R _{θJC(bot)}	Junction-to-case (bottom) thermal resistance	N/A	°C/W

(1) For more information about traditional and new thermal metrics, see the [Semiconductor and IC Package Thermal Metrics](#) application report.

6.5 Power Ratings

PARAMETER		TEST CONDITIONS	VALUE	UNIT
P _D	Maximum power dissipation (both sides)	VDD1 = VDD2 = 5.5 V	99	mW
P _{D1}	Maximum power dissipation (high-side)	VDD1 = 3.6 V	31	mW
		VDD1 = 5.5 V	54	
P _{D2}	Maximum power dissipation (low-side)	VDD2 = 3.6 V	26	mW
		VDD2 = 5.5 V	45	

6.6 Insulation Specifications

over operating ambient temperature range (unless otherwise noted)

PARAMETER		TEST CONDITIONS	VALUE	UNIT
GENERAL				
CLR	External clearance ⁽¹⁾	Shortest pin-to-pin distance through air	≥ 14.7	mm
CPG	External creepage ⁽¹⁾	Shortest pin-to-pin distance across the package surface	≥ 15.7	mm
DTI	Distance through insulation	Minimum internal gap (internal clearance) of the double insulation	≥ 21	μm
CTI	Comparative tracking index	DIN EN 60112 (VDE 0303-11); IEC 60112	≥ 600	V
	Material group	According to IEC 60664-1	I	
	Overvoltage category per IEC 60664-1	Rated mains voltage ≤ 600 V _{RMS}	I-IV	
		Rated mains voltage ≤ 1000 V _{RMS}	I-III	
DIN EN IEC 60747-17 (VDE 0884-17)⁽²⁾				
V _{IORM}	Maximum repetitive peak isolation voltage	At AC voltage	2800	V _{PK}
V _{IOWM}	Maximum-rated isolation working voltage	At AC voltage (sine wave)	2000	V _{RMS}
		At DC voltage	2800	V _{DC}
V _{IOTM}	Maximum transient isolation voltage	V _{TEST} = V _{IOTM} , t = 60 s (qualification test)	10600	V _{PK}
		V _{TEST} = 1.2 × V _{IOTM} , t = 1 s (100% production test)	12720	
V _{IMP}	Maximum impulse voltage ⁽³⁾	Tested in air, 1.2/50-μs waveform per IEC 62368-1	9800	V _{PK}
V _{IOSM}	Maximum surge isolation voltage ⁽⁴⁾	Tested in oil (qualification test), 1.2/50-μs waveform per IEC 62368-1	12800	V _{PK}
q _{pd}	Apparent charge ⁽⁵⁾	Method a, after input/output safety test subgroups 2 and 3, V _{ini} = V _{IOTM} , t _{ini} = 60 s, V _{pd(m)} = 1.2 × V _{IORM} , t _m = 10 s	≤ 5	pC
		Method a, after environmental tests subgroup 1, V _{ini} = V _{IOTM} , t _{ini} = 60 s, V _{pd(m)} = 1.6 × V _{IORM} , t _m = 10 s	≤ 5	
		Method b1, at routine test (100% production) and preconditioning (type test), V _{ini} = V _{IOTM} , t _{ini} = 1 s, V _{pd(m)} = 1.875 × V _{IORM} , t _m = 1 s	≤ 5	
C _{IO}	Barrier capacitance, input to output ⁽⁶⁾	V _{IO} = 0.5 V _{PP} at 1 MHz	~1.5	pF
R _{IO}	Insulation resistance, input to output ⁽⁶⁾	V _{IO} = 500 V at T _A = 25°C	> 10 ¹²	Ω
		V _{IO} = 500 V at 100°C ≤ T _A ≤ 125°C	> 10 ¹¹	
		V _{IO} = 500 V at T _S = 150°C	> 10 ⁹	
	Pollution degree		2	
	Climatic category		55/125/21	
UL1577				
V _{ISO}	Withstand isolation voltage	V _{TEST} = V _{ISO} = 7500 V _{RMS} , t = 60 s (qualification), V _{TEST} = 1.2 × V _{ISO} = 9000 V _{RMS} , t = 1 s (100% production test)	7500	V _{RMS}

- (1) Apply creepage and clearance requirements according to the specific equipment isolation standards of an application. Care must be taken to maintain the creepage and clearance distance of a board design to ensure that the mounting pads of the isolator on the printed circuit board (PCB) do not reduce this distance. Creepage and clearance on a PCB become equal in certain cases. Techniques such as inserting grooves, ribs, or both on a PCB are used to help increase these specifications.
- (2) This coupler is suitable for *safe electrical insulation* only within the safety ratings. Compliance with the safety ratings shall be ensured by means of suitable protective circuits.
- (3) Testing is carried out in air to determine the surge immunity of the package.
- (4) Testing is carried in oil to determine the intrinsic surge immunity of the isolation barrier.
- (5) Apparent charge is electrical discharge caused by a partial discharge (pd).
- (6) All pins on each side of the barrier are tied together, creating a two-pin device.

6.7 Safety-Related Certifications

VDE	UL
DIN EN IEC 60747-17 (VDE 0884-17), EN IEC 60747-17, DIN EN IEC 62368-1 (VDE 0868-1), EN IEC 62368-1, IEC 62368-1 Clause : 5.4.3 ; 5.4.4.4 ; 5.4.9	Recognized under 1577 component recognition program
Reinforced insulation	Single protection
Certificate number: 40040142 (pending)	File number: E181974

6.8 Safety Limiting Values

Safety limiting⁽¹⁾ intends to minimize potential damage to the isolation barrier upon failure of input or output circuitry. A failure of the I/O can allow low resistance to ground or the supply and, without current limiting, dissipate sufficient power to over-heat the die and damage the isolation barrier potentially leading to secondary system failures.

PARAMETER		TEST CONDITIONS	MIN	TYP	MAX	UNIT
I _S	Safety input, output, or supply current	R _{θJA} = 63.2°C/W, VDD _X = 3.6 V, T _J = 150°C, T _A = 25°C			550	mA
		R _{θJA} = 63.2°C/W, VDD _X = 5.5 V, T _J = 150°C, T _A = 25°C			360	
P _S	Safety input, output, or total power	R _{θJA} = 63.2°C/W, T _J = 150°C, T _A = 25°C			1980	mW
T _S	Maximum safety temperature				150	°C

- (1) The maximum safety temperature, T_S, has the same value as the maximum junction temperature, T_J, specified for the device. The I_S and P_S parameters represent the safety current and safety power, respectively. Do not exceed the maximum limits of I_S and P_S. These limits vary with the ambient temperature, T_A.

The junction-to-air thermal resistance, R_{θJA}, in the [Thermal Information](#) table is that of a device installed on a high-K test board for leaded surface-mount packages. Use these equations to calculate the value for each parameter:

$T_J = T_A + R_{\theta JA} \times P$, where P is the power dissipated in the device.

$T_{J(max)} = T_S = T_A + R_{\theta JA} \times P_S$, where T_{J(max)} is the maximum junction temperature.

$P_S = I_S \times VDD_{max}$, where VDD_{max} is the maximum supply voltage for high-side and low-side.

6.9 Electrical Characteristics

minimum and maximum specifications apply from $T_A = -40^\circ\text{C}$ to $+125^\circ\text{C}$, $V_{DD1} = 3.0\text{ V}$ to 5.5 V , $V_{DD2} = 3.0\text{ V}$ to 5.5 V , $I_{NP} = -250\text{ mV}$ to $+250\text{ mV}$, and $I_{NN} = \text{GND1}$; typical specifications are at $T_A = 25^\circ\text{C}$, $V_{DD1} = 5\text{ V}$, and $V_{DD2} = 3.3\text{ V}$ (unless otherwise noted)

PARAMETER	TEST CONDITIONS	MIN	TYP	MAX	UNIT		
ANALOG INPUT							
V_{OS}	Input offset voltage ^{(1) (2)}	$T_A = 25^\circ\text{C}$, $I_{NP} = I_{NN} = \text{GND1}$		-0.2	± 0.01	0.2	mV
TCV_{OS}	Input offset drift ^{(1) (2) (4)}			-0.9	± 0.1	0.9	$\mu\text{V}/^\circ\text{C}$
CMRR	Common-mode rejection ratio	$f_{IN} = 0\text{ Hz}$, $V_{CM\ min} \leq V_{CM} \leq V_{CM\ max}$				-100	dB
		$f_{IN} = 10\text{ kHz}$, $V_{CM\ min} \leq V_{CM} \leq V_{CM\ max}$				-98	
R_{IN}	Single-ended input resistance	$I_{NN} = \text{GND1}$				19	k Ω
R_{IND}	Differential input resistance					22	k Ω
I_{IB}	Input bias current	$I_{NP} = I_{NN} = \text{GND1}$; $I_{IB} = (I_{IBP} + I_{IBN}) / 2$		-41	-30	-24	μA
I_{IO}	Input offset current	$I_{IO} = I_{IBP} - I_{IBN}$; $I_{NP} = I_{NN} = \text{GND1}$				± 5	nA
C_{IN}	Single-ended input capacitance	$I_{NN} = \text{GND1}$, $f_{IN} = 275\text{ kHz}$				2	pF
C_{IND}	Differential input capacitance	$f_{IN} = 275\text{ kHz}$				1	pF
ANALOG OUTPUT							
	Nominal gain					8.2	V/V
E_G	Gain error ⁽¹⁾	$T_A = 25^\circ\text{C}$		-0.3%	$\pm 0.04\%$	0.3%	
TCE_G	Gain drift ^{(1) (5)}			-30	± 5	30	ppm/ $^\circ\text{C}$
	Nonlinearity ⁽¹⁾			-0.03%	$\pm 0.01\%$	0.03%	
THD	Total harmonic distortion ⁽³⁾	$f_{IN} = 10\text{ kHz}$				-85	dB
	Output noise	$I_{NP} = I_{NN} = \text{GND1}$, $f_{IN} = 0\text{ Hz}$, $BW = 100\text{ kHz}$ brickwall filter				230	μV_{RMS}
SNR	Signal-to-noise ratio	$f_{IN} = 1\text{ kHz}$, $BW = 10\text{ kHz}$		81.5	85		dB
		$f_{IN} = 10\text{ kHz}$, $BW = 100\text{ kHz}$				72	
PSRR	Power-supply rejection ratio ⁽²⁾	PSRR vs V_{DD1} , at DC				-100	dB
		PSRR vs V_{DD1} , 100-mV and 10-kHz ripple				-96	
		PSRR vs V_{DD2} , at DC				-106	
		PSRR vs V_{DD2} , 100-mV and 10-kHz ripple				-86	
V_{CMout}	Common-mode output voltage			1.39	1.44	1.49	V
$V_{CLIPout}$	Clipping differential output voltage	$V_{OUT} = (V_{OUTP} - V_{OUTN})$; $ V_{IN} = V_{INP} - V_{INN} > V_{Clipping} $		-2.52	± 2.49	2.52	V
$V_{Failsafe}$	Failsafe differential output voltage	V_{DD1} missing		-2.63	-2.57	-2.53	V
BW	Output bandwidth			250	310		kHz
R_{OUT}	Output resistance	On O_{UTP} or O_{UTN}				< 0.2	Ω
	Output short-circuit current	On O_{UTP} or O_{UTN} , sourcing or sinking, $I_{NN} = \text{GND1}$, outputs shorted to either GND2 or V_{DD2}				14	mA
CMTI	Common-mode transient immunity			100	150		kV/ μs

6.9 Electrical Characteristics (continued)

minimum and maximum specifications apply from $T_A = -40^\circ\text{C}$ to $+125^\circ\text{C}$, $V_{DD1} = 3.0\text{ V}$ to 5.5 V , $V_{DD2} = 3.0\text{ V}$ to 5.5 V , $\text{INP} = -250\text{ mV}$ to $+250\text{ mV}$, and $\text{INN} = \text{GND1}$; typical specifications are at $T_A = 25^\circ\text{C}$, $V_{DD1} = 5\text{ V}$, and $V_{DD2} = 3.3\text{ V}$ (unless otherwise noted)

PARAMETER		TEST CONDITIONS	MIN	TYP	MAX	UNIT
POWER SUPPLY						
VDD1 _{UV}	VDD1 undervoltage detection threshold	VDD1 rising	2.5	2.7	2.9	V
		VDD1 falling	2.4	2.6	2.8	
VDD2 _{UV}	VDD2 undervoltage detection threshold	VDD2 rising	2.2	2.45	2.65	V
		VDD2 falling	1.85	2.0	2.2	
IDD1	High-side supply current	$3.0\text{ V} \leq V_{DD1} \leq 3.6\text{ V}$		6.3	8.5	mA
		$4.5\text{ V} \leq V_{DD1} \leq 5.5\text{ V}$		7.2	9.8	
IDD2	Low-side supply current	$3.0\text{ V} \leq V_{DD2} \leq 3.6\text{ V}$		5.3	7.2	mA
		$4.5\text{ V} \leq V_{DD2} \leq 5.5\text{ V}$		5.9	8.1	

- (1) The typical value includes one standard deviation (*sigma*) at nominal operating conditions.
- (2) This parameter is input referred.
- (3) THD is the ratio of the rms sum of the amplitudes of first five higher harmonics to the amplitude of the fundamental.
- (4) Offset error temperature drift is calculated using the box method, as described by the following equation:

$$TCV_{OS} = (Value_{MAX} - Value_{MIN}) / TempRange$$
- (5) Gain error temperature drift is calculated using the box method, as described by the following equation:

$$TCE_G (ppm) = (Value_{MAX} - Value_{MIN}) / (Value_{(T=25^\circ\text{C})} \times TempRange) \times 10^6$$

6.10 Switching Characteristics

over operating ambient temperature range (unless otherwise noted)

PARAMETER		TEST CONDITIONS	MIN	TYP	MAX	UNIT
t_r	Output signal rise time			1.3		μs
t_f	Output signal fall time			1.3		μs
	V_{INx} to V_{OUTx} signal delay (50% - 10%)	Unfiltered output		1	1.5	μs
	V_{INx} to V_{OUTx} signal delay (50% - 50%)	Unfiltered output		1.6	2.1	μs
	V_{INx} to V_{OUTx} signal delay (50% - 90%)	Unfiltered output		2.5	3	μs
t_{AS}	Analog settling time	VDD1 step to 3.0 V with $V_{DD2} \geq 3.0\text{ V}$, to V_{OUTP} , V_{OUTN} valid, 0.1% settling		500		μs

6.11 Timing Diagram

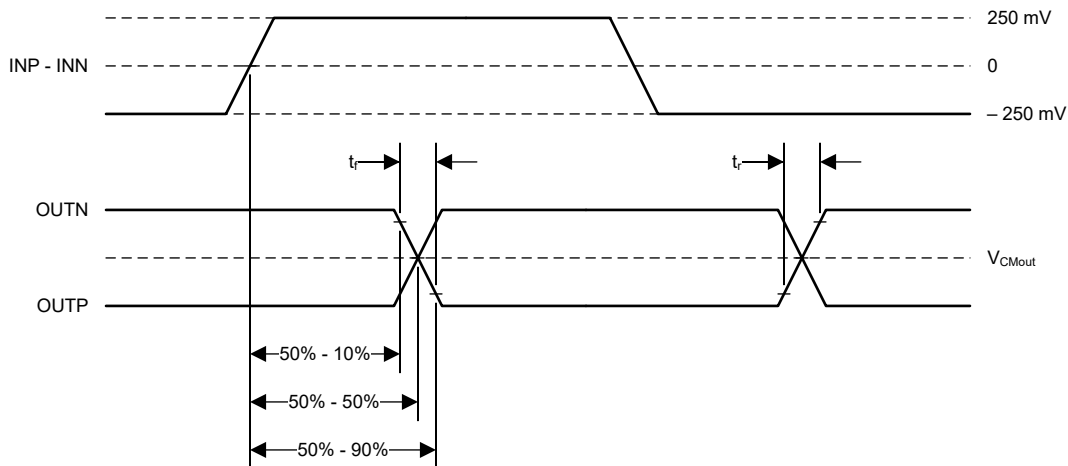

Figure 6-1. Rise, Fall, and Delay Time Definition

6.12 Insulation Characteristics Curves

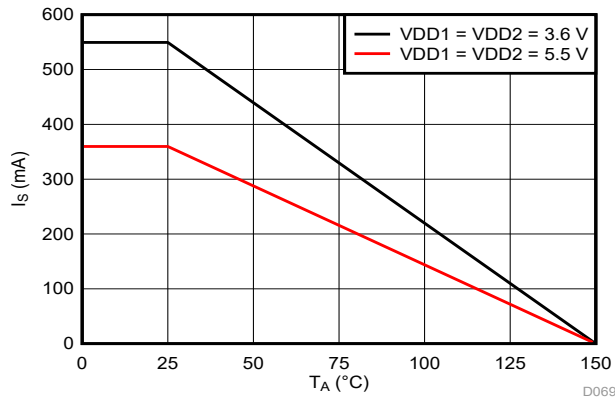

Figure 6-2. Thermal Derating Curve for Safety-Limiting Current per VDE

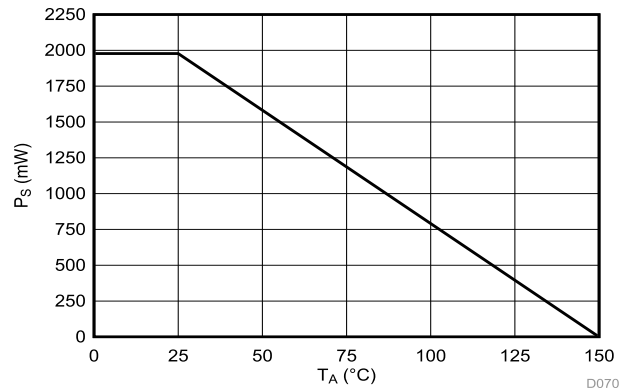
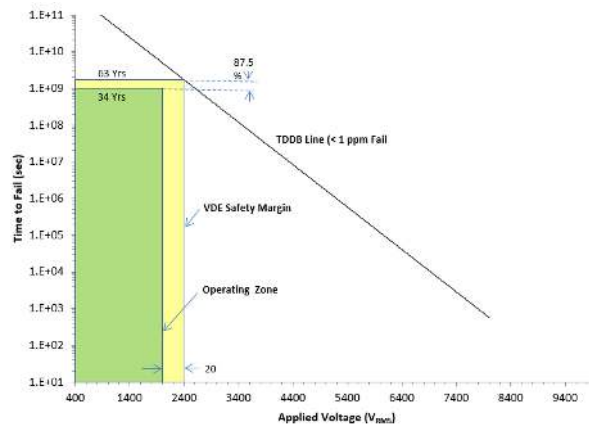

Figure 6-3. Thermal Derating Curve for Safety-Limiting Power per VDE



T_A up to 150°C, stress-voltage frequency = 60 Hz, isolation working voltage = 2000 V_{RMS} , operating lifetime = 34 year

Figure 6-4. Reinforced Isolation Capacitor Lifetime Projection

6.13 Typical Characteristics

at VDD1 = 5 V, VDD2 = 3.3 V, INP = -250 mV to 250 mV, INN = 0 V, and $f_{IN} = 10$ kHz (unless otherwise noted)

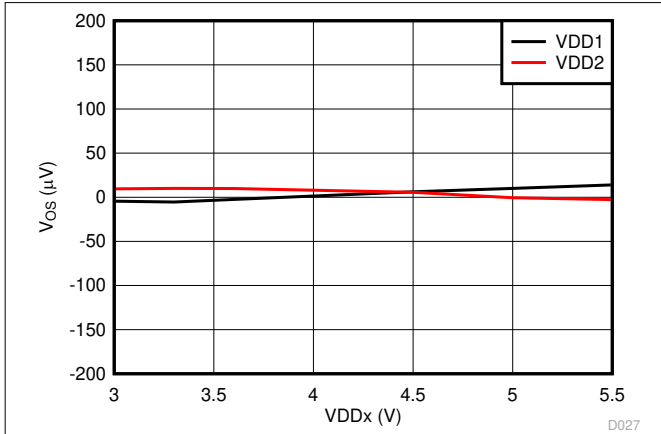

Figure 6-5. Input Offset Voltage vs Supply Voltage

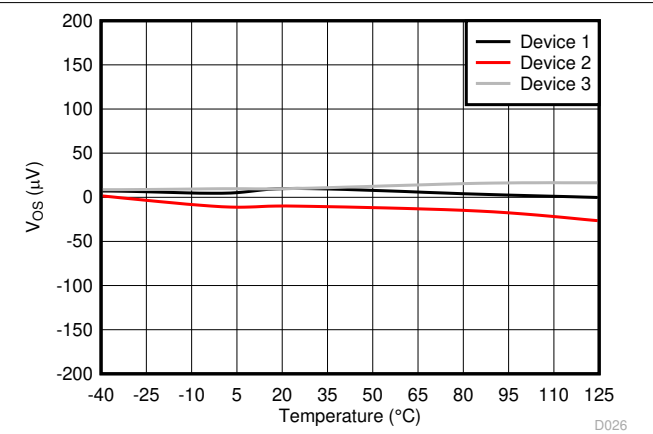

Figure 6-6. Input Offset Voltage vs Temperature

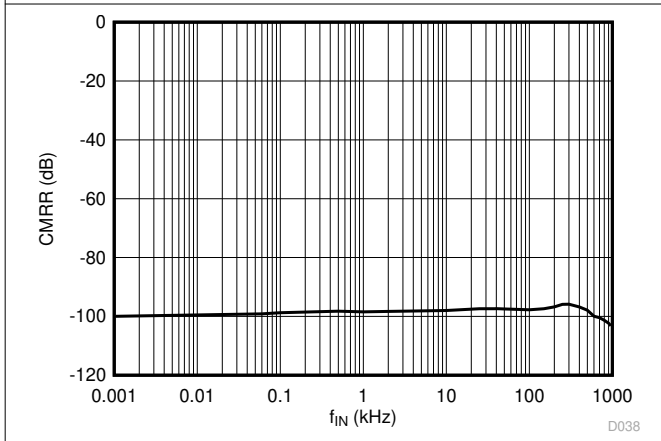

Figure 6-7. Common-Mode Rejection Ratio vs Input Frequency

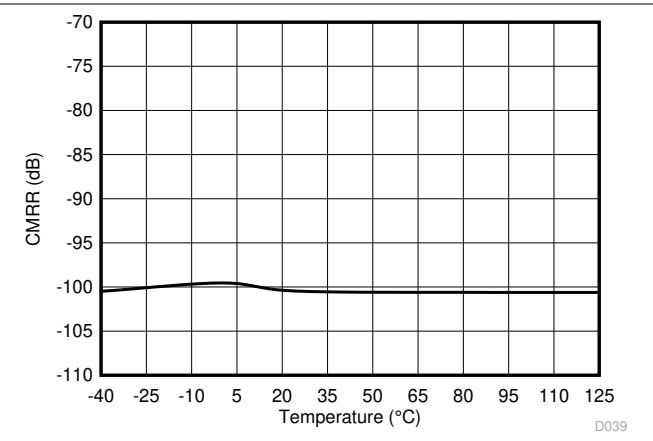

Figure 6-8. Common-Mode Rejection Ratio vs Temperature

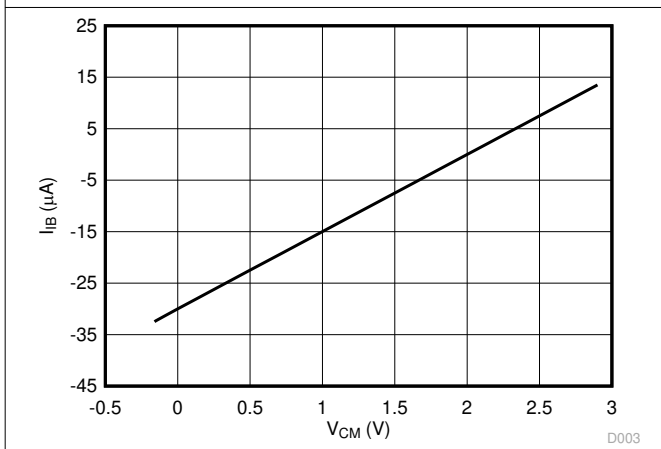

Figure 6-9. Input Bias Current vs Common-Mode Input Voltage

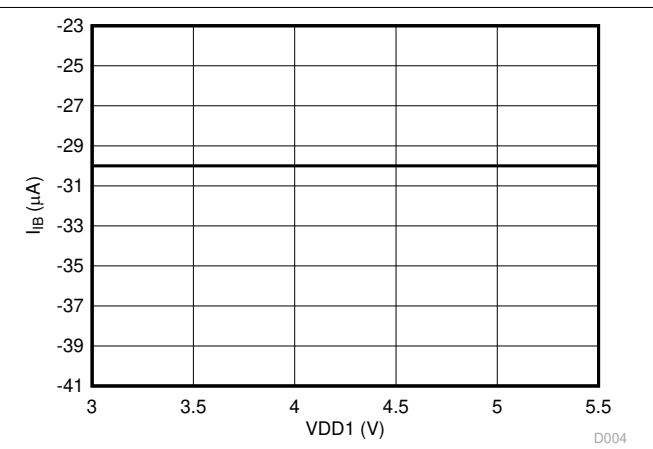

Figure 6-10. Input Bias Current vs High-Side Supply Voltage

6.13 Typical Characteristics (continued)

at VDD1 = 5 V, VDD2 = 3.3 V, INP = -250 mV to 250 mV, INN = 0 V, and f_{IN} = 10 kHz (unless otherwise noted)

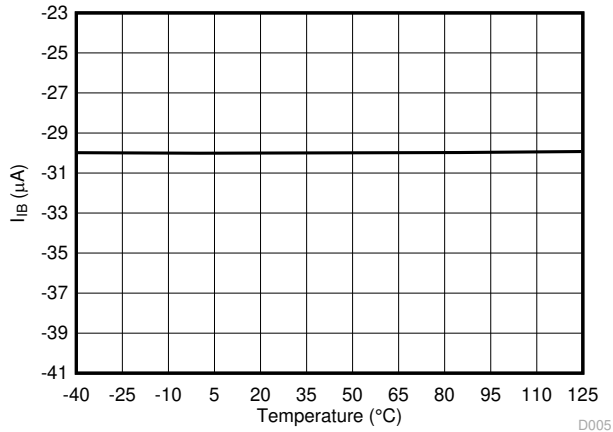

Figure 6-11. Input Bias Current vs Temperature

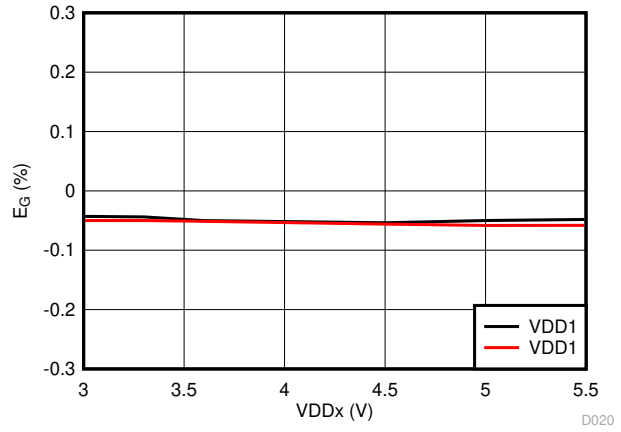

Figure 6-12. Gain Error vs Supply Voltage

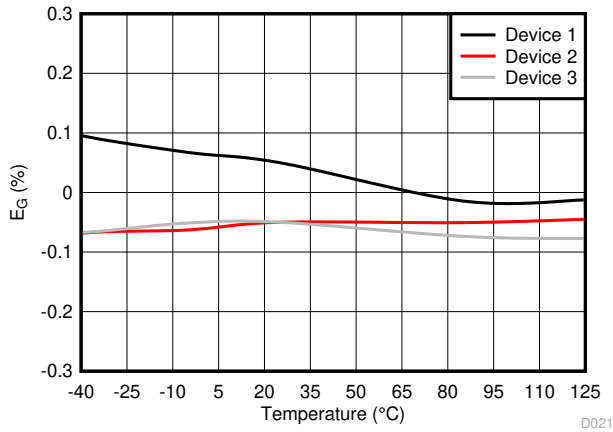

Figure 6-13. Gain Error vs Temperature

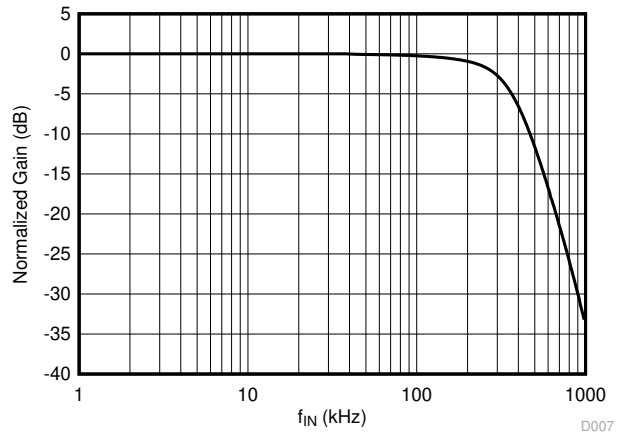

Figure 6-14. Normalized Gain vs Input Frequency

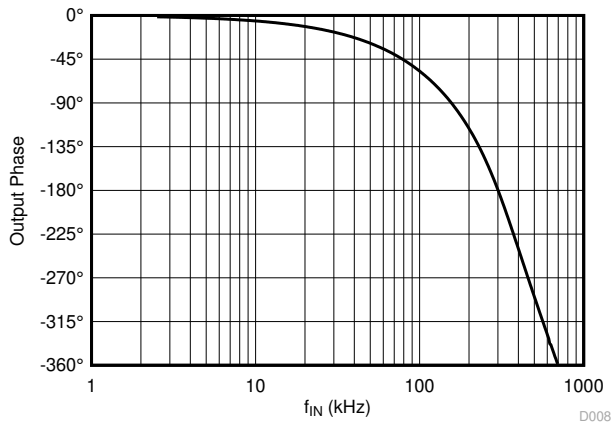

Figure 6-15. Output Phase vs Input Frequency

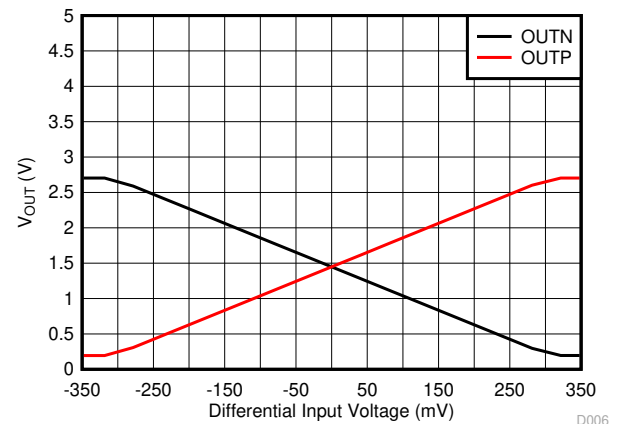
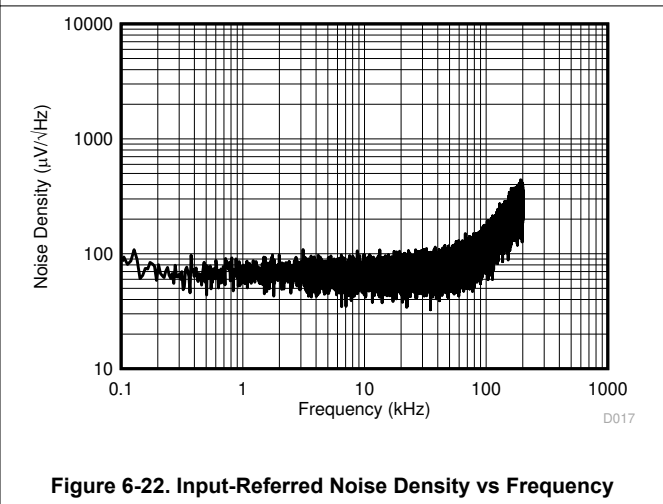
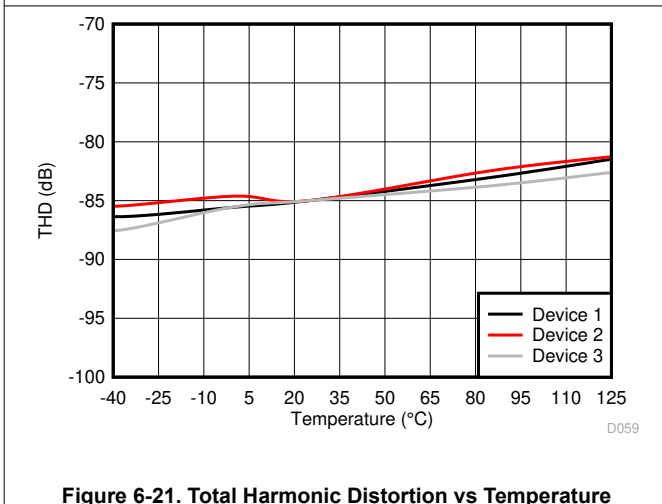
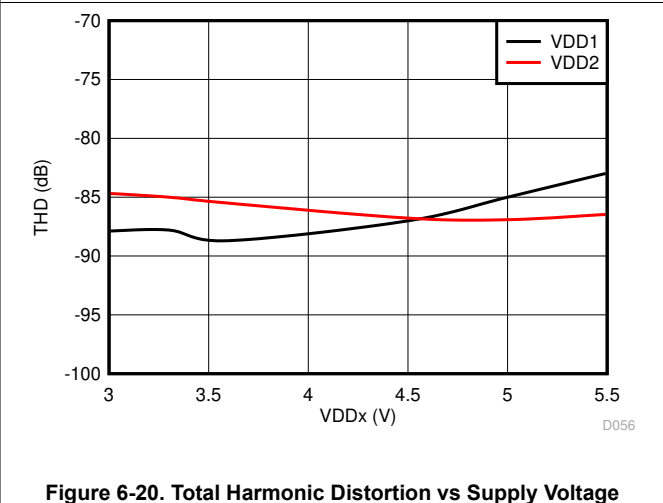
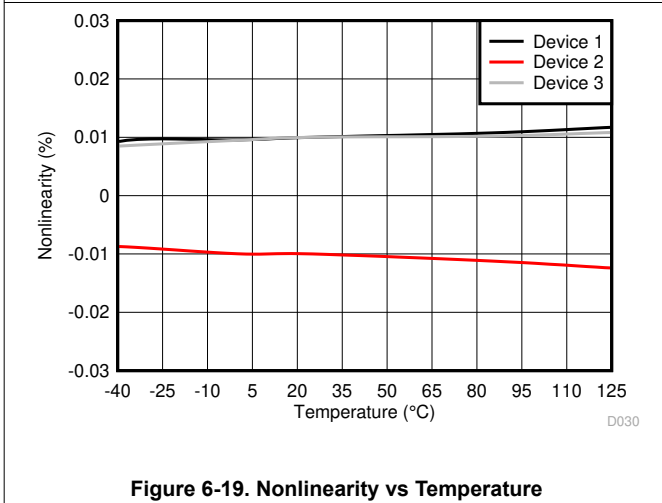
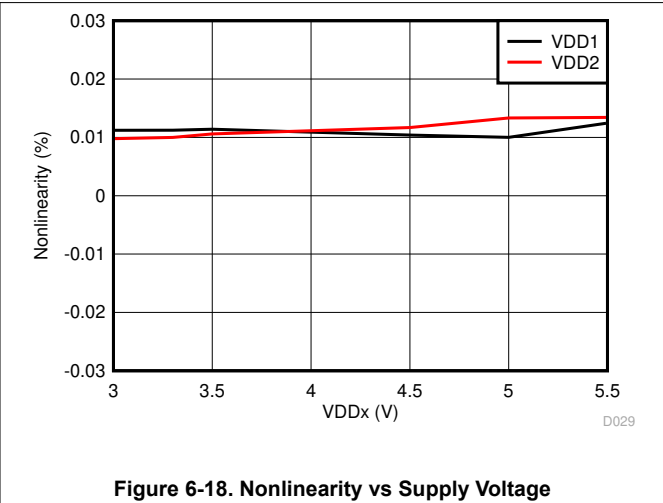
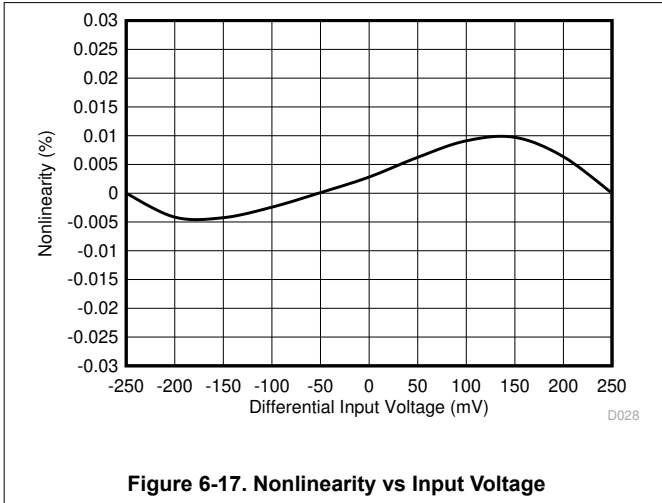

Figure 6-16. Output Voltage vs Input Voltage

6.13 Typical Characteristics (continued)

at VDD1 = 5 V, VDD2 = 3.3 V, INP = -250 mV to 250 mV, INN = 0 V, and $f_{IN} = 10$ kHz (unless otherwise noted)



6.13 Typical Characteristics (continued)

at VDD1 = 5 V, VDD2 = 3.3 V, INP = -250 mV to 250 mV, INN = 0 V, and $f_{IN} = 10$ kHz (unless otherwise noted)

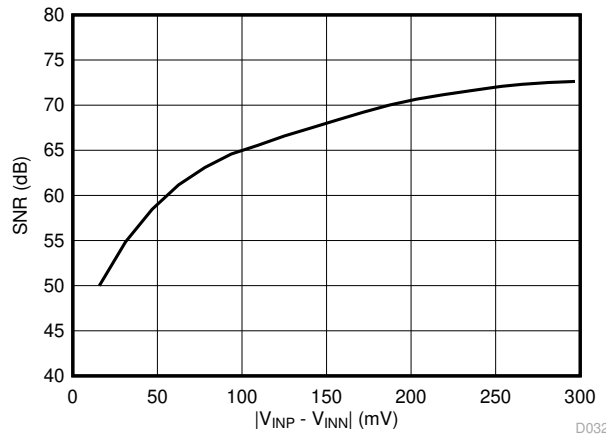

Figure 6-23. Signal-to-Noise Ratio vs Input Voltage

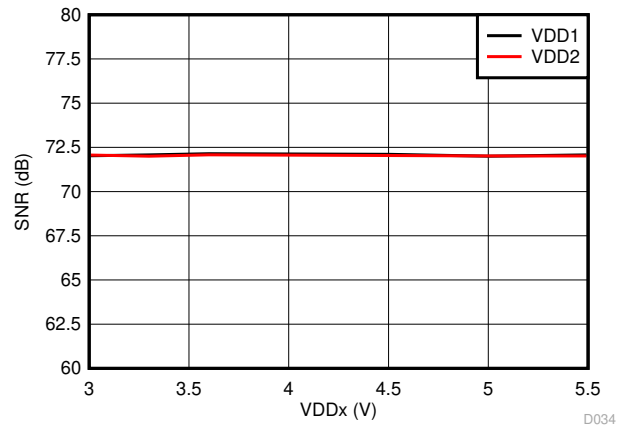

Figure 6-24. Signal-to-Noise Ratio vs Supply Voltage

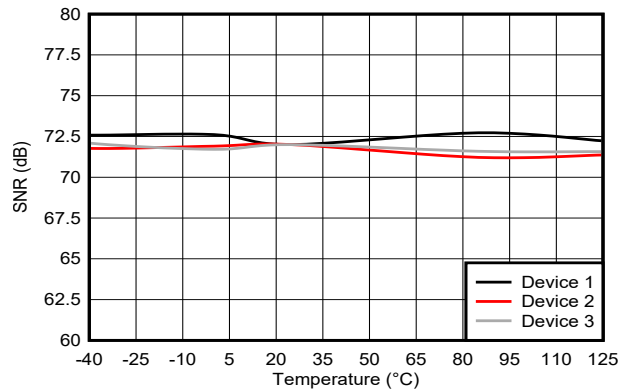

Figure 6-25. Signal-to-Noise Ratio vs Temperature

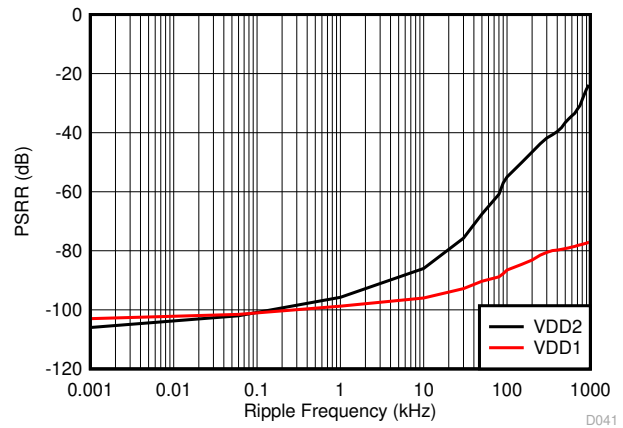

Figure 6-26. Power-Supply Rejection Ratio vs Ripple Frequency

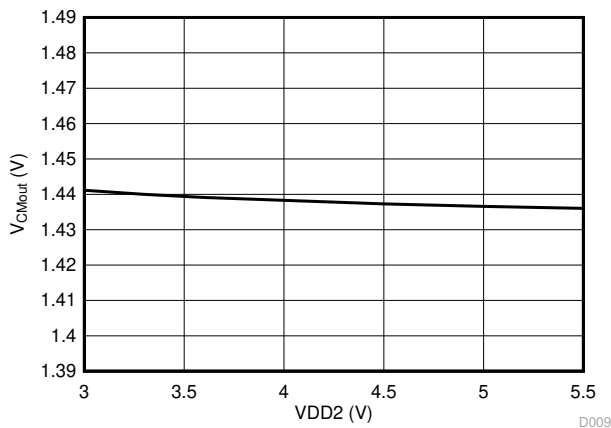

Figure 6-27. Output Common-Mode Voltage vs Low-Side Supply Voltage

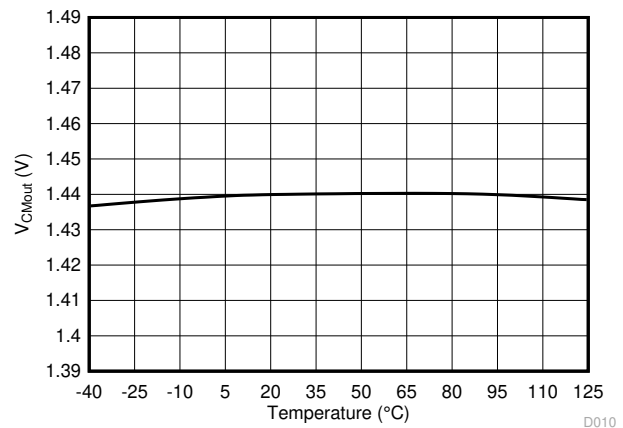

Figure 6-28. Output Common-Mode Voltage vs Temperature

6.13 Typical Characteristics (continued)

at VDD1 = 5 V, VDD2 = 3.3 V, INP = -250 mV to 250 mV, INN = 0 V, and $f_{IN} = 10$ kHz (unless otherwise noted)

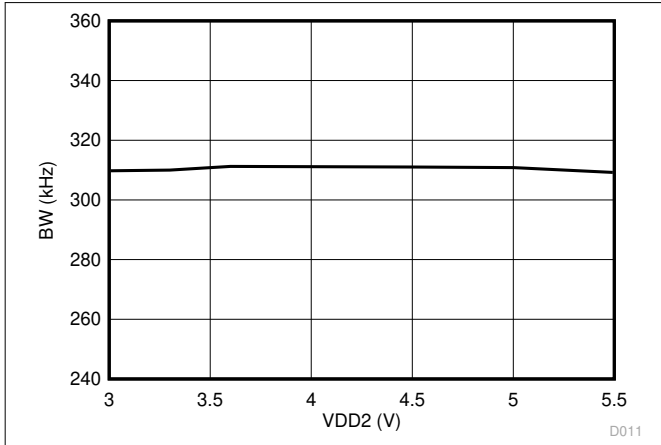

Figure 6-29. Output Bandwidth vs Low-Side Supply Voltage

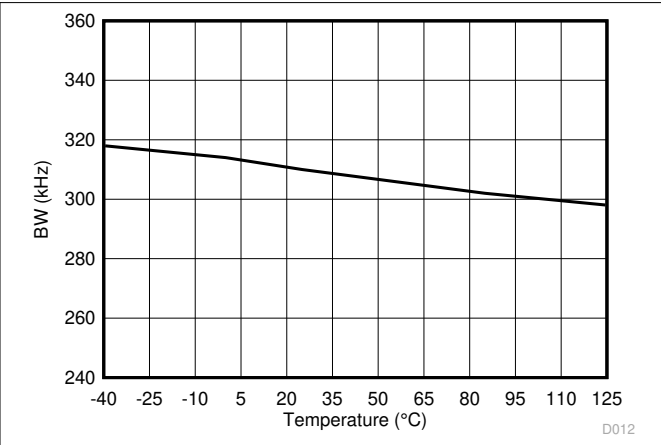

Figure 6-30. Output Bandwidth vs Temperature

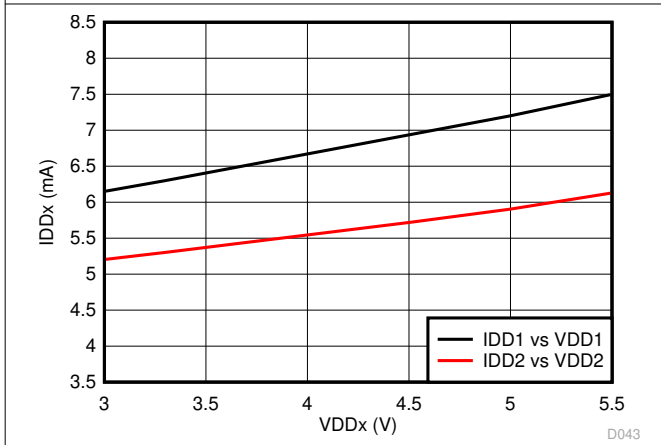

Figure 6-31. Supply Current vs Supply Voltage

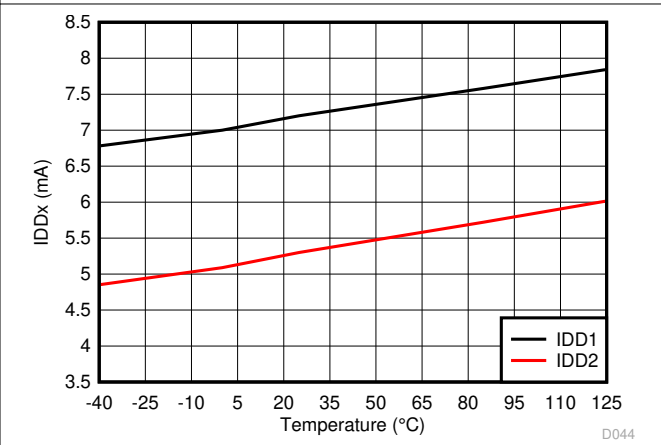

Figure 6-32. Supply Current vs Temperature

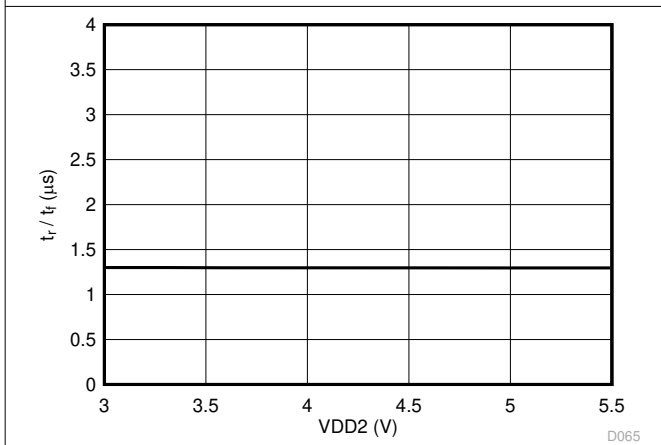

Figure 6-33. Output Rise and Fall Time vs Low-Side Supply

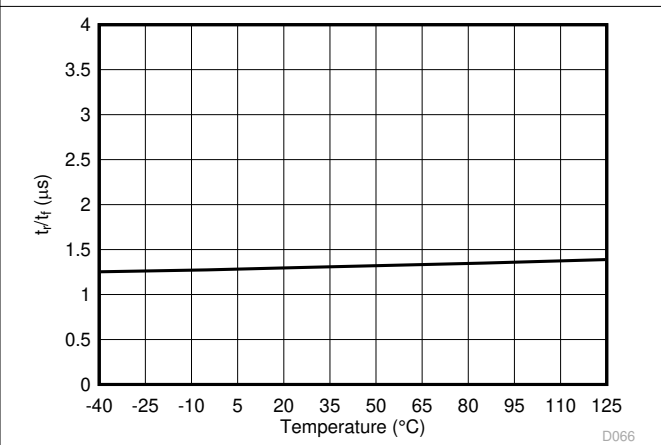

Figure 6-34. Output Rise and Fall Time vs Temperature

6.13 Typical Characteristics (continued)

at VDD1 = 5 V, VDD2 = 3.3 V, INP = -250 mV to 250 mV, INN = 0 V, and $f_{IN} = 10$ kHz (unless otherwise noted)

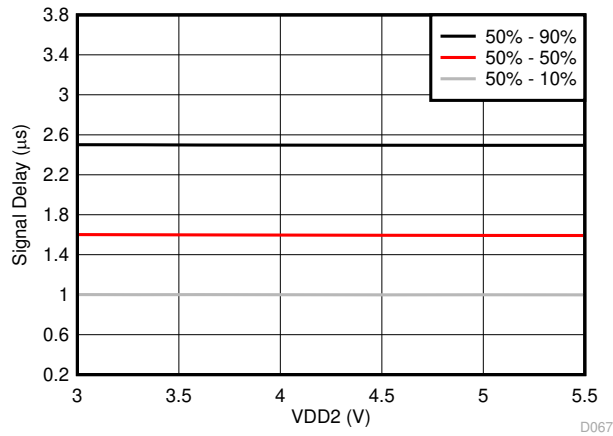

Figure 6-35. V_{IN} to V_{OUT} Signal Delay vs Low-Side Supply Voltage

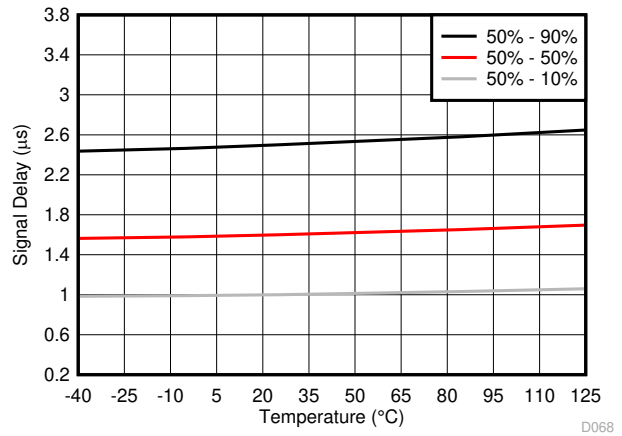

Figure 6-36. V_{IN} to V_{OUT} Signal Delay vs Temperature

7 Detailed Description

7.1 Overview

The AMC1400 is a fully differential, precision, isolated amplifier. The input stage of the device consists of a fully differential amplifier that drives a second-order, delta-sigma ($\Delta\Sigma$) modulator. The modulator converts the analog input signal into a digital bitstream that is transferred across the isolation barrier that separates the high-side from the low-side. On the low-side, the received bitstream is processed by a fourth-order analog filter that outputs a differential signal at the OUPN and OUTN pins that is proportional to the input signal.

The SiO₂-based, capacitive isolation barrier supports a high level of magnetic field immunity, as described in the [ISO72x Digital Isolator Magnetic-Field Immunity application report](#). The digital modulation used in the AMC1400 to transmit data across the isolation barrier, and the isolation barrier characteristics itself, result in high reliability and common-mode transient immunity.

7.2 Functional Block Diagram

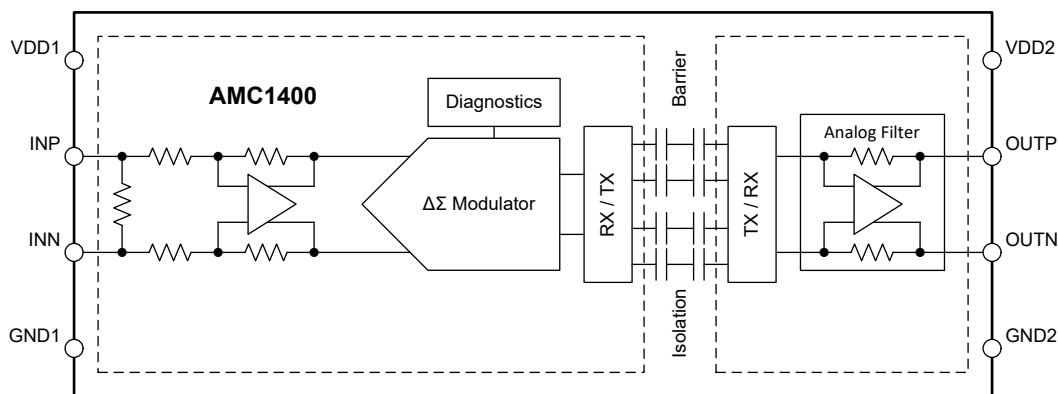

7.3 Feature Description

7.3.1 Analog Input

The differential amplifier input stage of the AMC1400 feeds a second-order, switched-capacitor, feed-forward $\Delta\Sigma$ modulator. The gain of the differential amplifier is set by internal precision resistors with a differential input impedance of R_{IND} . The modulator converts the analog input signal into a bitstream that is transferred across the isolation barrier, as described in the [Isolation Channel Signal Transmission](#) section.

There are two restrictions on the analog input signals INP and INN. First, if the input voltages V_{INP} or V_{INN} exceed the range specified in the [Absolute Maximum Ratings](#) table, the input currents must be limited to the absolute maximum value, because the electrostatic discharge (ESD) protection turns on. In addition, the linearity and parametric performance of the device are ensured only when the analog input voltage remains within the linear full-scale range (V_{FSR}) and within the common-mode input voltage range (V_{CM}), as specified in the [Recommended Operating Conditions](#) table.

7.3.2 Isolation Channel Signal Transmission

The AMC1400 uses an on-off keying (OOK) modulation scheme, as shown in [Figure 7-1](#), to transmit the modulator output bitstream across the SiO₂-based isolation barrier. The transmit driver (TX) shown in the [Functional Block Diagram](#) transmits an internally-generated, high-frequency carrier across the isolation barrier to represent a digital *one* and does not send a signal to represent a digital *zero*. The nominal frequency of the carrier used inside the AMC1400 is 480 MHz.

The receiver (RX) on the other side of the isolation barrier recovers and demodulates the signal and provides the input to the fourth-order analog filter. The AMC1400 transmission channel is optimized to achieve the highest level of common-mode transient immunity (CMTI) and lowest level of radiated emissions caused by the high-frequency carrier and RX/TX buffer switching.

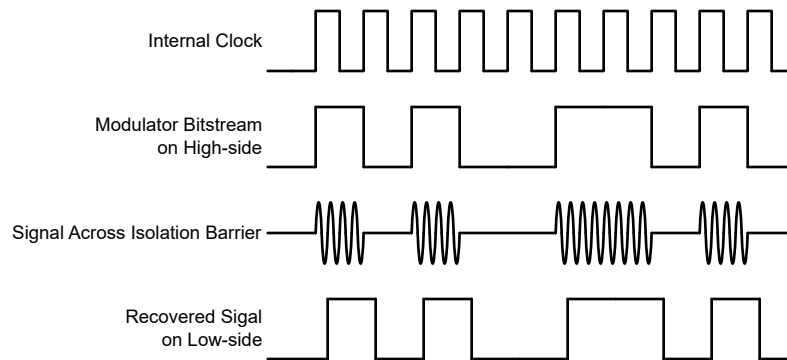

Figure 7-1. OOK-Based Modulation Scheme

7.3.3 Analog Output

The AMC1400 offers a differential analog output comprised of the OOUTP and OOUTN pins. For differential input voltages ($V_{INP} - V_{INN}$) in the range from -250 mV to $+250\text{ mV}$, the device provides a linear response with a nominal gain of 8.2. For example, for a differential input voltage of 250 mV , the differential output voltage ($V_{OOUTP} - V_{OOUTN}$) is 2.05 V . At zero input (INP shorted to INN), both pins output the same common-mode output voltage V_{CMout} , as specified in the [Electrical Characteristics](#) table. For absolute differential input voltages greater than 250 mV but less than 320 mV , the differential output voltage continues to increase in magnitude but with reduced linearity performance. The outputs saturate at a differential output voltage of $V_{CLIPout}$, as shown in [Figure 7-2](#), if the differential input voltage exceeds the $V_{Clipping}$ value.

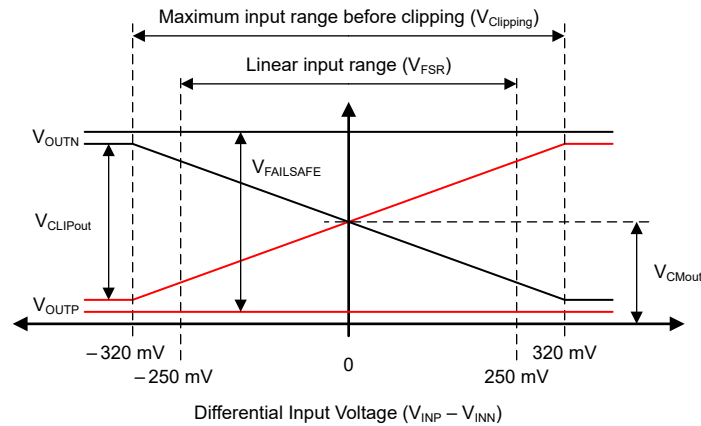

Figure 7-2. Output Behavior of the AMC1400

The AMC1400 offers a fail-safe feature that simplifies diagnostics on a system level. [Figure 7-2](#) shows the fail-safe mode, in which the AMC1400 outputs a negative differential output voltage that does not occur under normal operating conditions. The fail-safe output is active in two cases:

- When the high-side supply is missing or below the V_{DD1UV} threshold
- When the common-mode input voltage, that is $V_{CM} = (V_{INP} + V_{INN}) / 2$, exceeds the common-mode overvoltage detection level V_{CMov}

Use the maximum $V_{FAILSAFE}$ voltage specified in the [Electrical Characteristics](#) table as a reference value for fail-safe detection on a system level.

7.4 Device Functional Modes

The AMC1400 is operational when the power supplies V_{DD1} and V_{DD2} are applied, as specified in the [Recommended Operating Conditions](#) table.

8 Application and Implementation

Note

Information in the following applications sections is not part of the TI component specification, and TI does not warrant its accuracy or completeness. TI's customers are responsible for determining suitability of components for their purposes, as well as validating and testing their design implementation to confirm system functionality.

8.1 Application Information

With its stretched SOIC package, the AMC1400 is specifically designed for isolated, high precision, shunt-based current sensing in applications with 800-V and higher working voltages. This device is designed for operating in harsh environments with a high pollution degree or high altitudes.

8.2 Typical Application

[Figure 8-1](#) depicts a simplified block diagram of a solar inverter supporting a 1000-V_{DC} string voltage where the AMC1400 is used to monitor the current on the 1200-V DC link. The output current of the boost converter flows through a shunt resistor (RSHUNT) and produces a voltage drop that is sensed by the AMC1400. The AMC1400 outputs a differential analog voltage that is proportional to the input signal and galvanically isolated from the high-voltage side. The differential output voltage is typically routed to an analog-to-digital converter (ADC) of a microcontroller (MCU) to complete the current-sensing signal chain. The [AMC1411](#) is used in the same application for measuring the DC link voltage. Both devices share a common high-side power supply based on the [SN6501](#) push-pull driver and a transformer that supports the desired isolation voltage ratings.

The stretched SOIC package, differential input, differential output, and the high common-mode transient immunity (CMTI) of the AMC1400 ensure reliable and accurate operation in high-noise environments while meeting IEC standards for reinforced isolation at 1 kV and higher working voltages.

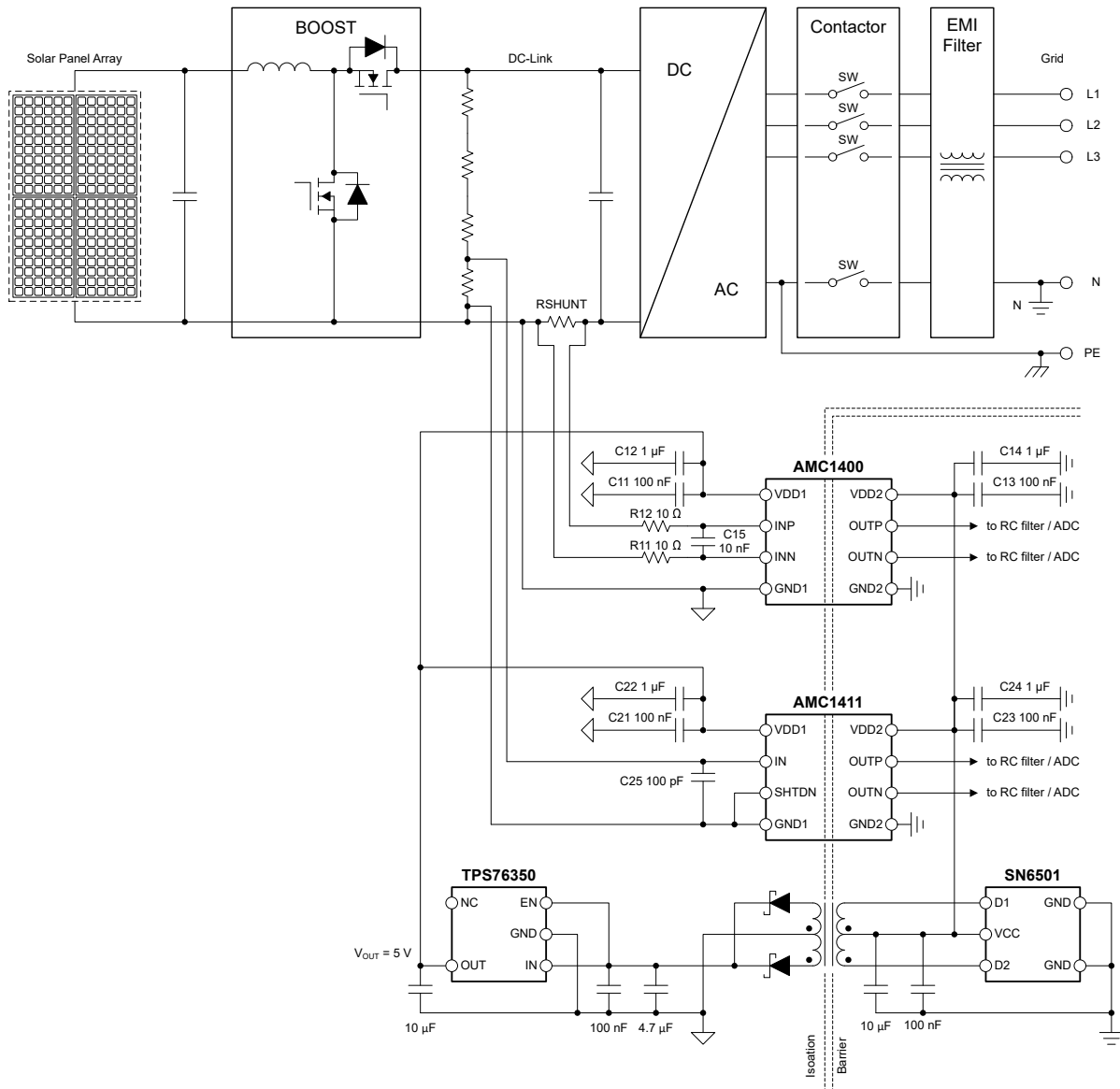

Figure 8-1. Using the AMC1400 for Current Sensing in a Typical Application

8.2.1 Design Requirements

Table 8-1 lists the parameters for this typical application.

Table 8-1. Design Requirements

PARAMETER	VALUE
DC link voltage	1200 V (maximum)
Overvoltage category	III
Pollution degree	2
Altitude	≤2000 m
High-side supply voltage	3.3 V or 5 V
Low-side supply voltage	3.3 V or 5 V
Transient peak DC link current	10 A
Nominal DC link current	4 A
Voltage drop across RSHUNT for a linear response	±250 mV (maximum)
Maximum voltage drop across RSHUNT before clipping	±320 mV (maximum)

8.2.2 Detailed Design Procedure

The value of the shunt resistor (RSHUNT) is selected such that the transient peak DC link current (10 A) produces a voltage drop across the shunt resistor that matches the linear full-scale input range of the AMC1400 (250 mV). Consider the following two restrictions when selecting the value of the shunt resistor:

- The voltage drop across the shunt caused by the nominal-rated DC link current range must not exceed the recommended differential input voltage range for a linear response: $|V_{SHUNT}| \leq |V_{FSR}|$
- The voltage drop caused by the maximum allowed overcurrent must not exceed the input voltage that causes a clipping output: $|V_{SHUNT}| \leq |V_{Clipping}|$

In this example, a 25-mΩ shunt resistor is selected (RSHUNT = 250 mV / 10 A).

At the nominal-rated current, the power dissipation in the shunt resistor is $R \times I^2 = 25 \text{ m}\Omega \times (4 \text{ A})^2 = 0.4 \text{ W}$. For surface-mounted shunts, the heat is mainly dissipated via the device terminals and the printed circuit board (PCB) traces. The power rating of a shunt is typically specified for a 70°C terminal temperature and derated for higher temperatures. This rating ensures that the shunt itself does not exceed its specified maximum operating temperature at the rated power dissipation. Careful PCB design is required not to exceed the terminal temperature at the rated power dissipation. Using wide copper traces to spread the heat over a larger area of the PCB, heat sinks, and air flow can improve the thermal design.

8.2.2.1 Input Filter Design

Place an RC filter in front of the isolated amplifier to improve the signal-to-noise performance of the signal path. Design the input filter such that:

- The cutoff frequency of the filter is at least one order of magnitude lower than the sampling frequency (20 MHz) of the $\Delta\Sigma$ modulator
- The input bias current does not generate a significant voltage drop across the DC impedance of the input filter
- The impedances measured from the analog inputs are equal

For most applications, the structure shown in [Figure 8-2](#) achieves excellent performance.

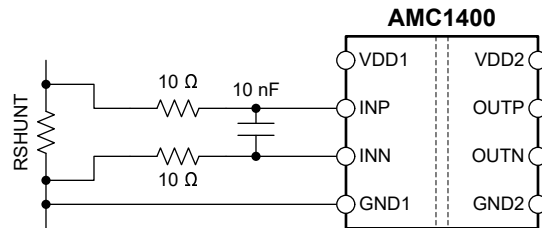

Figure 8-2. Differential Input Filter

8.2.2.2 Differential to Single-Ended Output Conversion

[Figure 8-3](#) shows an example of a [TLV9001](#)-based signal conversion and filter circuit for systems using single-ended input ADCs to convert the analog output voltage into digital. With $R1 = R2 = R3 = R4$, the output voltage equals $(V_{OUTP} - V_{OUTN}) + V_{REF}$. Tailor the bandwidth of this filter stage to the bandwidth requirement of the system and use NP0-type capacitors for best performance. For most applications, $R1 = R2 = R3 = R4 = 3.3\text{ k}\Omega$ and $C1 = C2 = 330\text{ pF}$ yields good performance.

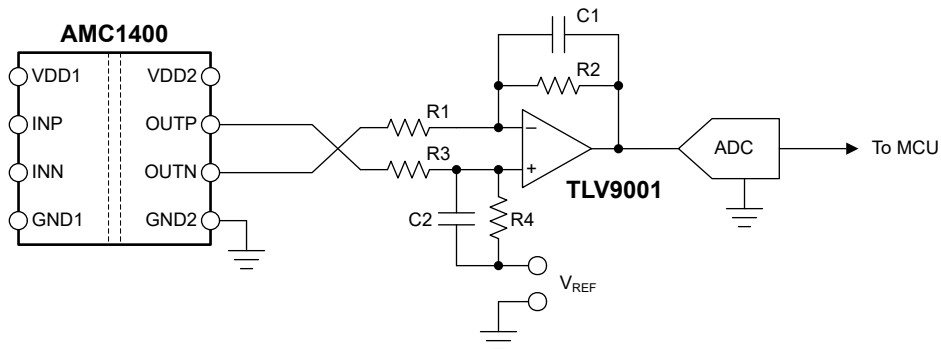

Figure 8-3. Connecting the AMC1400 Output to a Single-Ended Input ADC

For more information on the general procedure to design the filtering and driving stages of SAR ADCs, see the [18-Bit, 1MSPS Data Acquisition Block \(DAQ\) Optimized for Lowest Distortion and Noise](#) and [18-Bit Data Acquisition Block \(DAQ\) Optimized for Lowest Power reference guides](#), available for download at www.ti.com.

8.2.3 Application Curve

One important aspect of a power-stage design is the effective detection of an overcurrent condition to protect the switching devices and passive components from damage. To power off the system quickly in the event of an overcurrent condition, a low delay caused by the isolated amplifier is required. Figure 8-4 shows the typical full-scale step response of the AMC1400.

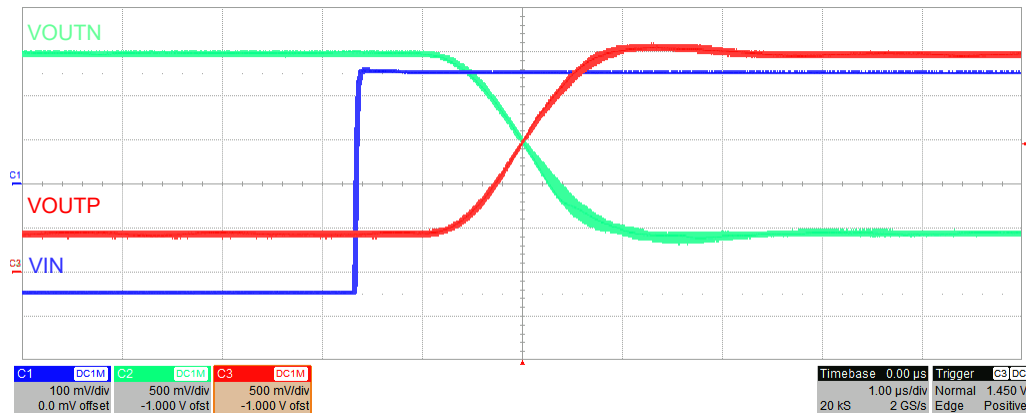

Figure 8-4. Step Response of the AMC1400

8.3 Best Design Practices

Do not leave the inputs of the AMC1400 unconnected (floating) when the device is powered up. If the device inputs are left floating, the input bias current may drive the inputs to a positive value that exceeds the operating common-mode input voltage and the output voltage may not be valid.

Connect the high-side ground (GND1) to INN, either by a hard short or through a resistive path. A DC current path between INN and GND1 is required to define the input common-mode voltage. Take care not to exceed the input common-mode range, as specified in the [Recommended Operating Conditions](#) table. For best accuracy, route the ground connection as a separate trace that connects directly to the shunt resistor rather than shorting GND1 to INN directly at the input to the device. See the [Layout](#) section for more details.

8.4 Power Supply Recommendations

The AMC1400 does not require any specific power-up sequencing. The high-side power supply (VDD1) is decoupled with a low-ESR, 100-nF capacitor (C1) parallel to a low-ESR, 1- μ F capacitor (C2). The low-side power supply (VDD2) is equally decoupled with a low-ESR, 100-nF capacitor (C3) parallel to a low-ESR, 1- μ F capacitor (C4). Place all four capacitors (C1, C2, C3, and C4) as close to the device as possible.

The ground reference for the high-side (GND1) is derived from the end of the shunt resistor, which is connected to the negative input (INN) of the device. For best DC accuracy, use a separate trace (as shown in [Figure 8-5](#)) to make this connection instead of shorting GND1 to INN directly at the device input. If a four-terminal shunt is used, the device inputs are connected to the inner leads and GND1 is connected to the outer lead on the INN-side of the shunt.

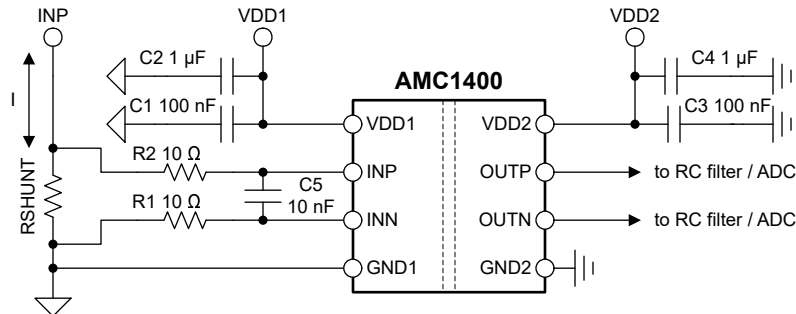

Figure 8-5. Decoupling of the AMC1400

Capacitors must provide adequate effective capacitance under the applicable DC bias conditions they experience in the application. Multilayer ceramic capacitors (MLCCs) typically exhibit only a fraction of their nominal capacitance under real-world conditions and this factor must be taken into consideration when selecting these capacitors. This problem is especially acute in low-profile capacitors, in which the dielectric field strength is higher than in taller components. Reputable capacitor manufacturers provide capacitance versus DC bias curves that greatly simplify component selection.

8.5 Layout

8.5.1 Layout Guidelines

Figure 8-6 shows a layout recommendation with the critical placement of the decoupling capacitors (as close as possible to the AMC1400 supply pins) and placement of the other components required by the device. For best performance, place the shunt resistor close to the INP and INN inputs of the AMC1400 and keep the layout of both connections symmetrical.

The ground pin (GND1) of the AMC1400 is connected to the same end of the shunt resistor that is connected to the negative input pin (INN) of the AMC1400. If a four-pin shunt is used, the input pins (INN and INP) of the AMC1400 are connected to the inner leads, and the GND1 pin is connected to the outer lead on the INN-side of the shunt resistor. To minimize offset and improve accuracy, route the ground connection as a separate trace that connects directly to the shunt resistor rather than shorting GND1 to INN directly at the input to the device.

8.5.2 Layout Example

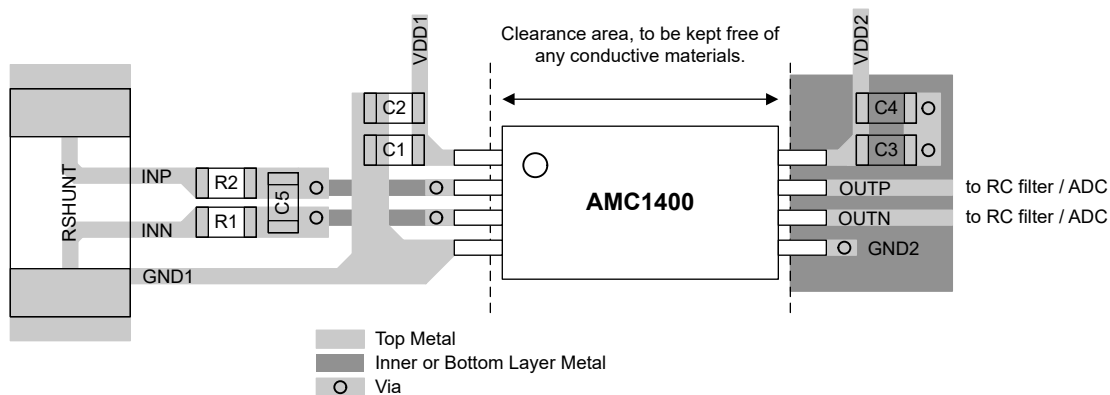

Figure 8-6. Recommended Layout of the AMC1400

9 Device and Documentation Support

9.1 Documentation Support

9.1.1 Related Documentation

For related documentation, see the following:

- Texas Instruments, [Isolation Glossary application note](#)
- Texas Instruments, [Semiconductor and IC Package Thermal Metrics application note](#)
- Texas Instruments, [ISO72x Digital Isolator Magnetic-Field Immunity application note](#)
- Texas Instruments, [TLV900x Low-Power, RRIO, 1-MHz Operational Amplifier for Cost-Sensitive Systems data sheet](#)
- Texas Instruments, [TPS763 Low-Power, 150-mA, Low-Dropout Linear Regulator data sheet](#)
- Texas Instrument, [SN6501 Transformer Driver for Isolated Power Supplies data sheet](#)
- Texas Instruments, [18-Bit, 1-MSPS Data Acquisition Block \(DAQ\) Optimized for Lowest Distortion and Noise reference guide](#)
- Texas Instruments, [18-Bit, 1-MSPS Data Acquisition Block \(DAQ\) Optimized for Lowest Power reference guide](#)
- Texas Instruments, [Isolated Amplifier Voltage Sensing Excel Calculator design tool](#)
- Texas Instruments, [Best in Class Radiated Emissions EMI Performance with the AMC1300B-Q1 Isolated Amplifier technical white paper](#)

9.2 Receiving Notification of Documentation Updates

To receive notification of documentation updates, navigate to the device product folder on ti.com. Click on *Subscribe to updates* to register and receive a weekly digest of any product information that has changed. For change details, review the revision history included in any revised document.

9.3 Support Resources

[TI E2E™ support forums](#) are an engineer's go-to source for fast, verified answers and design help — straight from the experts. Search existing answers or ask your own question to get the quick design help you need.

Linked content is provided "AS IS" by the respective contributors. They do not constitute TI specifications and do not necessarily reflect TI's views; see TI's [Terms of Use](#).

9.4 Trademarks

TI E2E™ is a trademark of Texas Instruments.
All trademarks are the property of their respective owners.

9.5 Electrostatic Discharge Caution



This integrated circuit can be damaged by ESD. Texas Instruments recommends that all integrated circuits be handled with appropriate precautions. Failure to observe proper handling and installation procedures can cause damage.

ESD damage can range from subtle performance degradation to complete device failure. Precision integrated circuits may be more susceptible to damage because very small parametric changes could cause the device not to meet its published specifications.

9.6 Glossary

[TI Glossary](#) This glossary lists and explains terms, acronyms, and definitions.

10 Mechanical, Packaging, and Orderable Information

The following pages include mechanical, packaging, and orderable information. This information is the most current data available for the designated devices. This data is subject to change without notice and revision of this document. For browser-based versions of this data sheet, refer to the left-hand navigation.

10.1 Mechanical Data



DWL0008A

PACKAGE OUTLINE
SOIC - 4.034 mm max height

PLASTIC SMALL OUTLINE

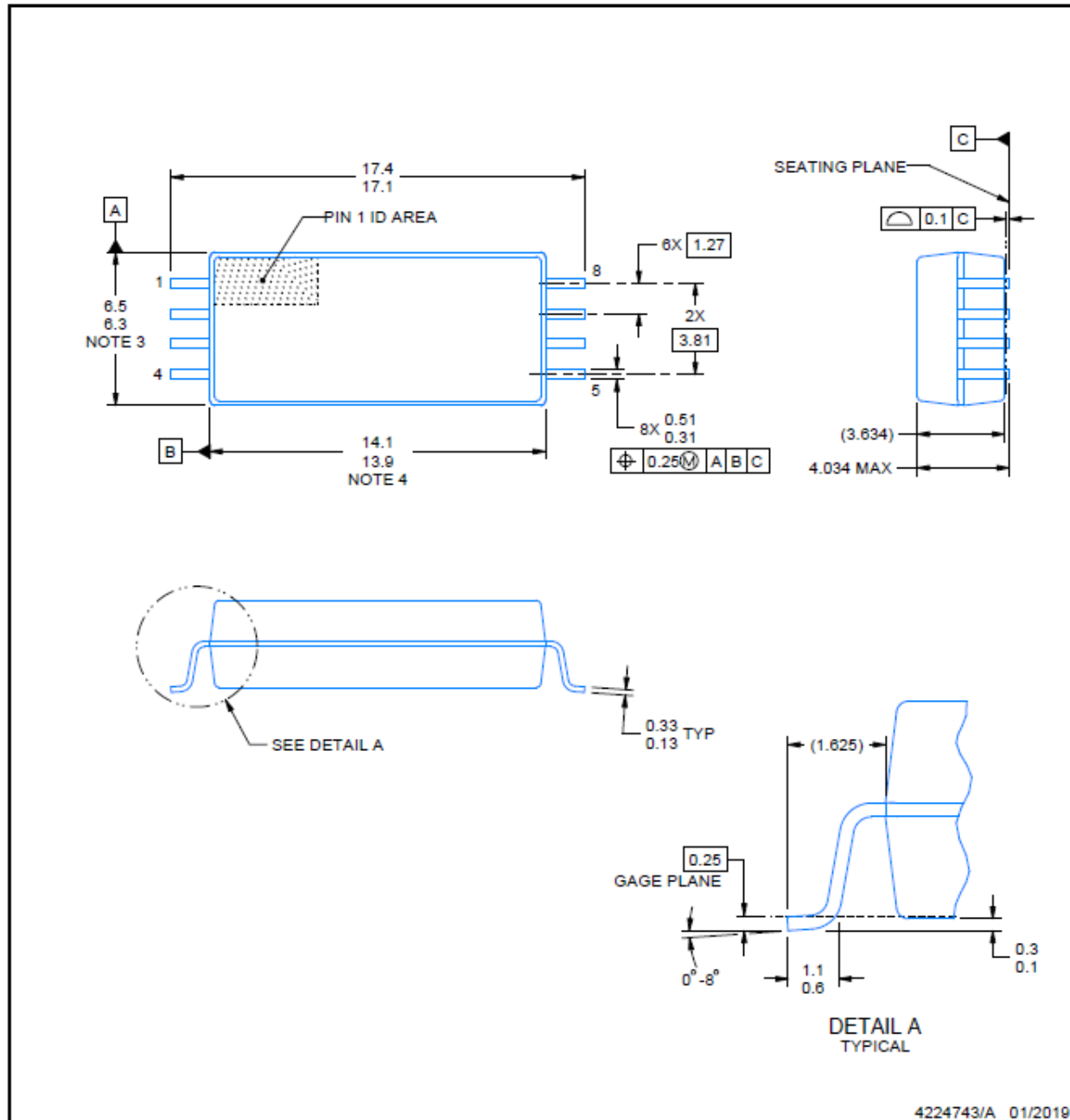

4224743/A 01/2019

NOTES:

- All linear dimensions are in millimeters. Any dimensions in parenthesis are for reference only. Dimensioning and tolerancing per ASME Y14.5M.
- This drawing is subject to change without notice.
- This dimension does not include mold flash, protrusions, or gate burrs. Mold flash, protrusions, or gate burrs shall not exceed 0,15 mm per side.
- This dimension does not include interlead flash.

EXAMPLE BOARD LAYOUT

DWL0008A

SOIC - 4.034 mm max height

PLASTIC SMALL OUTLINE

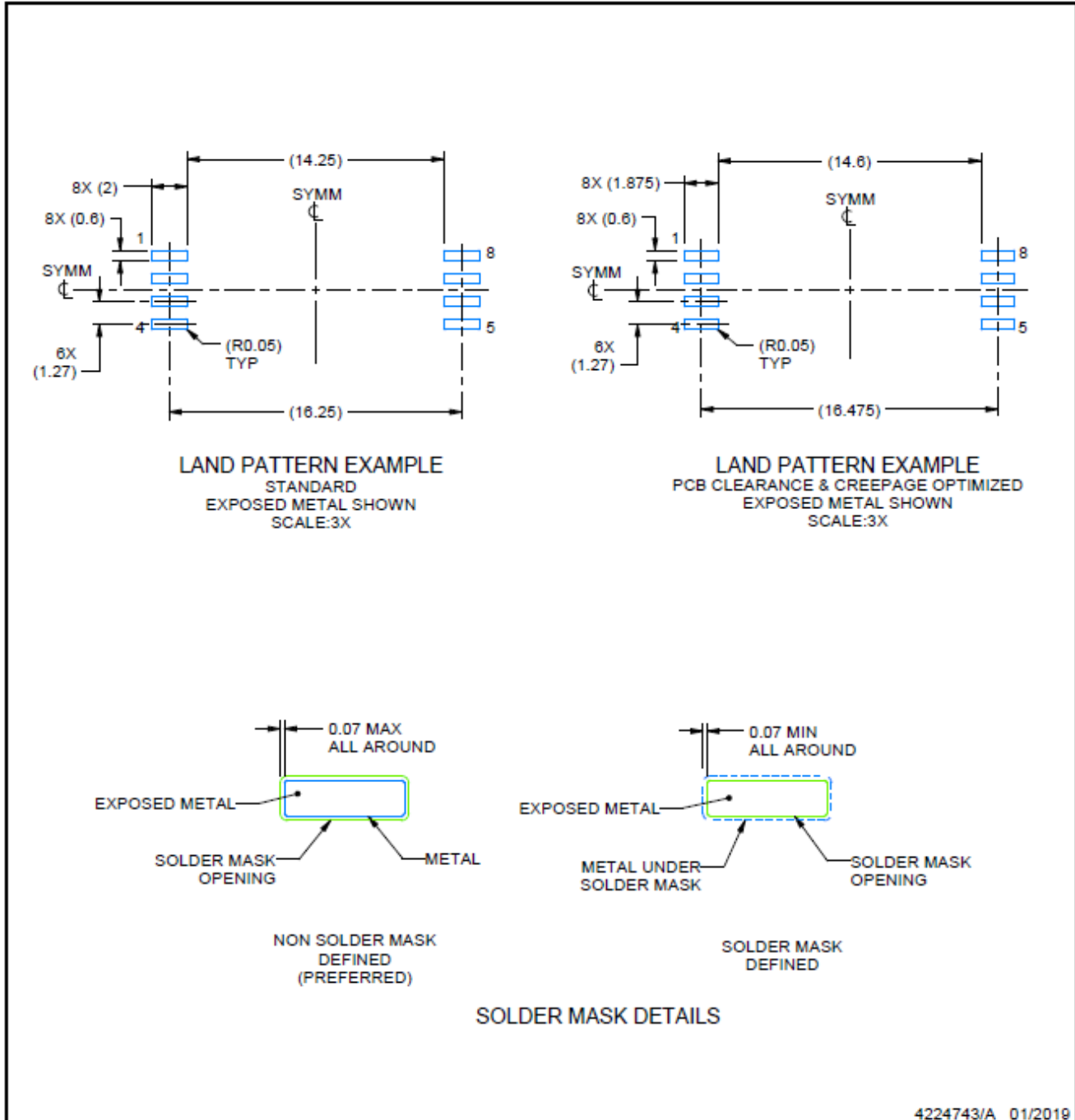

NOTES: (continued)

5. Publication IPC-7351 may have alternate designs.
6. Solder mask tolerances between and around signal pads can vary based on board fabrication site.

EXAMPLE STENCIL DESIGN

DWL0008A

SOIC - 4.034 mm max height

PLASTIC SMALL OUTLINE

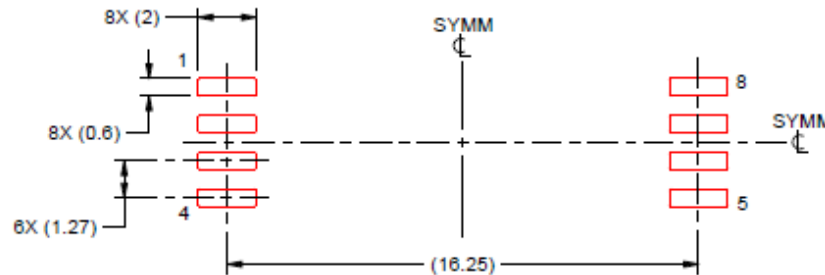

SOLDER PASTE EXAMPLE
STANDARD
BASED ON 0.125 mm THICK STENCIL
SCALE:4X

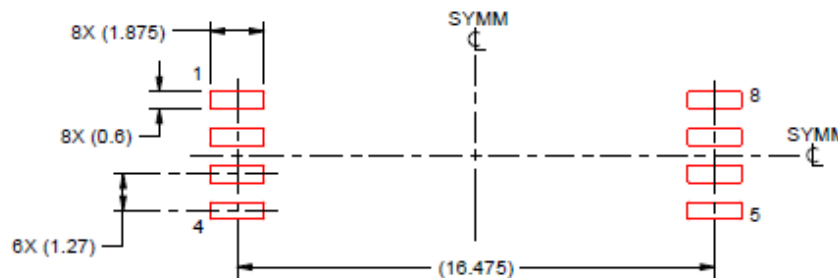

SOLDER PASTE EXAMPLE
PCB CLEARANCE & CREEPAGE OPTIMIZED
BASED ON 0.125 mm THICK STENCIL
SCALE:4X

4224743/A 01/2019

NOTES: (continued)

7. Laser cutting apertures with trapezoidal walls and rounded corners may offer better paste release. IPC-7525 may have alternate design recommendations.
8. Board assembly site may have different recommendations for stencil design.

PACKAGING INFORMATION

Orderable Device	Status (1)	Package Type	Package Drawing	Pins	Package Qty	Eco Plan (2)	Lead finish/ Ball material (6)	MSL Peak Temp (3)	Op Temp (°C)	Device Marking (4/5)	Samples
AMC1400DWLR	ACTIVE	SOIC	DWL	8	500	RoHS & Green	NIPDAU	Level-3-260C-168 HR	-40 to 125	1400	Samples

(1) The marketing status values are defined as follows:

ACTIVE: Product device recommended for new designs.

LIFEBUY: TI has announced that the device will be discontinued, and a lifetime-buy period is in effect.

NRND: Not recommended for new designs. Device is in production to support existing customers, but TI does not recommend using this part in a new design.

PREVIEW: Device has been announced but is not in production. Samples may or may not be available.

OBSELETE: TI has discontinued the production of the device.

(2) **RoHS:** TI defines "RoHS" to mean semiconductor products that are compliant with the current EU RoHS requirements for all 10 RoHS substances, including the requirement that RoHS substance do not exceed 0.1% by weight in homogeneous materials. Where designed to be soldered at high temperatures, "RoHS" products are suitable for use in specified lead-free processes. TI may reference these types of products as "Pb-Free".

RoHS Exempt: TI defines "RoHS Exempt" to mean products that contain lead but are compliant with EU RoHS pursuant to a specific EU RoHS exemption.

Green: TI defines "Green" to mean the content of Chlorine (Cl) and Bromine (Br) based flame retardants meet JS709B low halogen requirements of <=1000ppm threshold. Antimony trioxide based flame retardants must also meet the <=1000ppm threshold requirement.

(3) MSL, Peak Temp. - The Moisture Sensitivity Level rating according to the JEDEC industry standard classifications, and peak solder temperature.

(4) There may be additional marking, which relates to the logo, the lot trace code information, or the environmental category on the device.

(5) Multiple Device Markings will be inside parentheses. Only one Device Marking contained in parentheses and separated by a "-" will appear on a device. If a line is indented then it is a continuation of the previous line and the two combined represent the entire Device Marking for that device.

(6) Lead finish/Ball material - Orderable Devices may have multiple material finish options. Finish options are separated by a vertical ruled line. Lead finish/Ball material values may wrap to two lines if the finish value exceeds the maximum column width.

Important Information and Disclaimer:The information provided on this page represents TI's knowledge and belief as of the date that it is provided. TI bases its knowledge and belief on information provided by third parties, and makes no representation or warranty as to the accuracy of such information. Efforts are underway to better integrate information from third parties. TI has taken and continues to take reasonable steps to provide representative and accurate information but may not have conducted destructive testing or chemical analysis on incoming materials and chemicals. TI and TI suppliers consider certain information to be proprietary, and thus CAS numbers and other limited information may not be available for release.

In no event shall TI's liability arising out of such information exceed the total purchase price of the TI part(s) at issue in this document sold by TI to Customer on an annual basis.

OTHER QUALIFIED VERSIONS OF AMC1400 :

- Automotive : [AMC1400-Q1](#)

NOTE: Qualified Version Definitions:

- Automotive - Q100 devices qualified for high-reliability automotive applications targeting zero defects

TAPE AND REEL INFORMATION

QUADRANT ASSIGNMENTS FOR PIN 1 ORIENTATION IN TAPE

*All dimensions are nominal

Device	Package Type	Package Drawing	Pins	SPQ	Reel Diameter (mm)	Reel Width W1 (mm)	A0 (mm)	B0 (mm)	K0 (mm)	P1 (mm)	W (mm)	Pin1 Quadrant
AMC1400DWLR	SOIC	DWL	8	500	330.0	24.4	18.55	7.2	4.5	24.0	24.0	Q1

TAPE AND REEL BOX DIMENSIONS

*All dimensions are nominal

Device	Package Type	Package Drawing	Pins	SPQ	Length (mm)	Width (mm)	Height (mm)
AMC1400DWLR	SOIC	DWL	8	500	367.0	367.0	45.0

DWL0008A

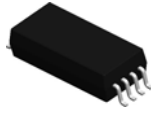

PACKAGE OUTLINE

SOIC - 4.034 mm max height

PLASTIC SMALL OUTLINE

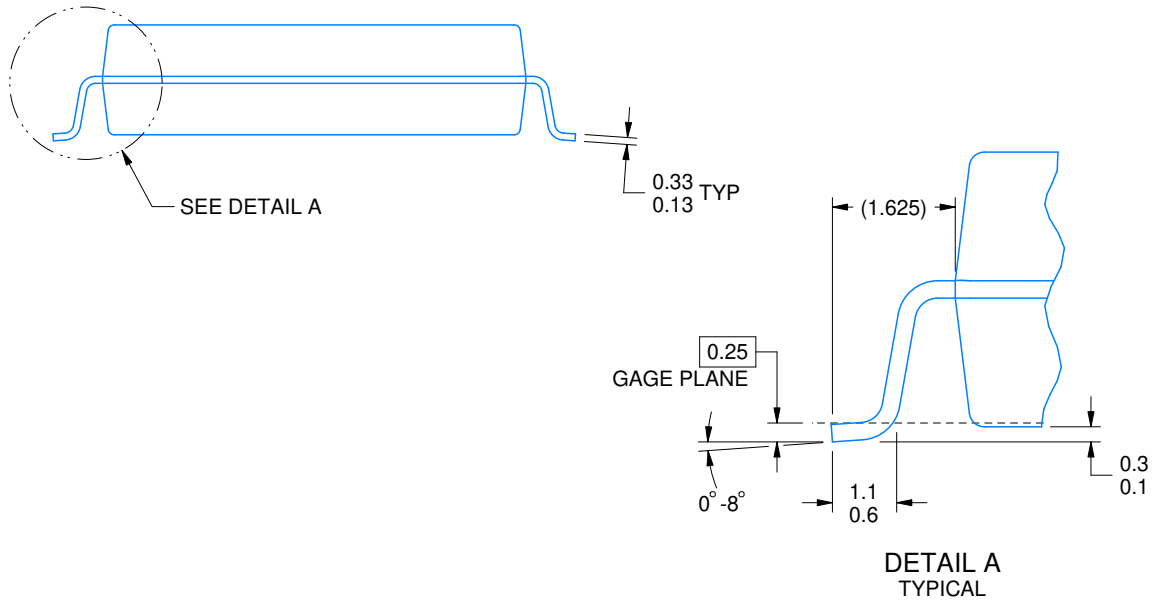
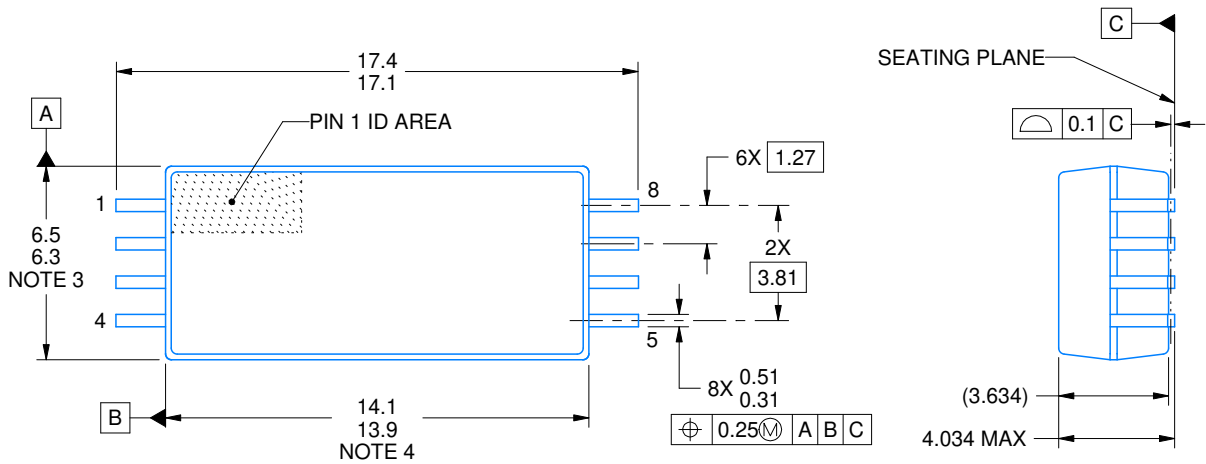

4224743/A 01/2019

NOTES:

1. All linear dimensions are in millimeters. Any dimensions in parenthesis are for reference only. Dimensioning and tolerancing per ASME Y14.5M.
2. This drawing is subject to change without notice.
3. This dimension does not include mold flash, protrusions, or gate burrs. Mold flash, protrusions, or gate burrs shall not exceed 0,15 mm per side.
4. This dimension does not include interlead flash.

EXAMPLE STENCIL DESIGN

DWL0008A

SOIC - 4.034 mm max height

PLASTIC SMALL OUTLINE

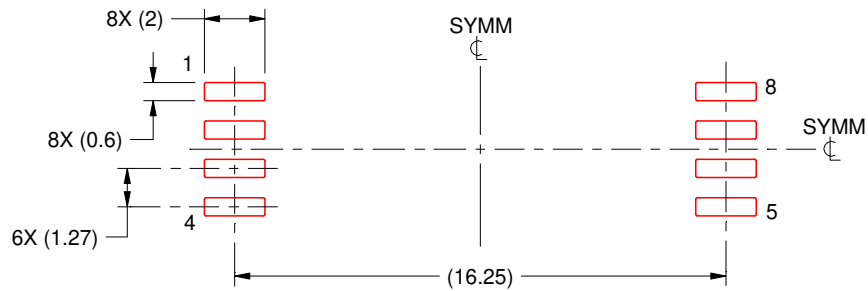

SOLDER PASTE EXAMPLE
STANDARD
BASED ON 0.125 mm THICK STENCIL
SCALE:4X

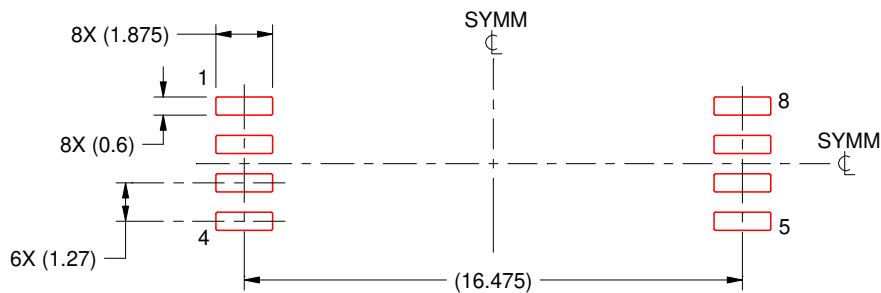

SOLDER PASTE EXAMPLE
PCB CLEARANCE & CREEPAGE OPTIMIZED
BASED ON 0.125 mm THICK STENCIL
SCALE:4X

4224743/A 01/2019

NOTES: (continued)

7. Laser cutting apertures with trapezoidal walls and rounded corners may offer better paste release. IPC-7525 may have alternate design recommendations.
8. Board assembly site may have different recommendations for stencil design.

IMPORTANT NOTICE AND DISCLAIMER

TI PROVIDES TECHNICAL AND RELIABILITY DATA (INCLUDING DATA SHEETS), DESIGN RESOURCES (INCLUDING REFERENCE DESIGNS), APPLICATION OR OTHER DESIGN ADVICE, WEB TOOLS, SAFETY INFORMATION, AND OTHER RESOURCES "AS IS" AND WITH ALL FAULTS, AND DISCLAIMS ALL WARRANTIES, EXPRESS AND IMPLIED, INCLUDING WITHOUT LIMITATION ANY IMPLIED WARRANTIES OF MERCHANTABILITY, FITNESS FOR A PARTICULAR PURPOSE OR NON-INFRINGEMENT OF THIRD PARTY INTELLECTUAL PROPERTY RIGHTS.

These resources are intended for skilled developers designing with TI products. You are solely responsible for (1) selecting the appropriate TI products for your application, (2) designing, validating and testing your application, and (3) ensuring your application meets applicable standards, and any other safety, security, regulatory or other requirements.

These resources are subject to change without notice. TI grants you permission to use these resources only for development of an application that uses the TI products described in the resource. Other reproduction and display of these resources is prohibited. No license is granted to any other TI intellectual property right or to any third party intellectual property right. TI disclaims responsibility for, and you will fully indemnify TI and its representatives against, any claims, damages, costs, losses, and liabilities arising out of your use of these resources.

TI's products are provided subject to [TI's Terms of Sale](#) or other applicable terms available either on ti.com or provided in conjunction with such TI products. TI's provision of these resources does not expand or otherwise alter TI's applicable warranties or warranty disclaimers for TI products.

TI objects to and rejects any additional or different terms you may have proposed.

Mailing Address: Texas Instruments, Post Office Box 655303, Dallas, Texas 75265
Copyright © 2022, Texas Instruments Incorporated