

ITEM	DESCRIPTION
1	SCREW
2	COVER ASSEMBLY
3	INSERT ASSEMBLY
4	GASKET

S05207TA122**

SERIES
 S05= INTERNAL THREAD FORM C
 POLES
 2= 2 POLE & 3= 3 POLE
 THREAD
 07= PG7, M2= M12x15
 MATERIAL AND HOUSING COLOUR
 G= PA6 GRAY, N= PA6 BLACK, W= PA6 BLACK V0, T= TRANSPARENT
 CIRCUIT
 SEE DETAILS IN CATALOGUE
 VOLTAGE
 SEE DETAILS IN CATALOGUE
 SCREW AND GASKET
 1= NBR PROFILE GASKET & SCREW
 2= NBR FLAT GASKET & SCREW
 3= WHITE SILICON PROFILE GASKET & SCREW
 4= WHITE SILICON FLAT GASKET & SCREW
 NON STANDARD COMPONENTS
 14= PACKED IN NEUTRAL BAG
 5N= PACKED IN BOXES OF 200





NOTES

- PLEASE SEE SHEET 2 FOR CURRENTLY CONFIGURED PART NUMBERS. FOR SPECIFIC PART NUMBERS PLEASE CONTACT SALES OR CONSULT THE INTELLIGENT PART NUMBERS IN THE TABLE ATTACHED.
- EARTH POSITION SHOWN, H6.
- FOR PACKAGING SEE PACKAGING SPEC PK-121065-S05
- PRODUCT SPEC: SEE PS-121201-001

LAST INSPECTION NUMBER 2

ADDED PART NUMBER	DESCRIPTION	QUALITY SYMBOLS	GENERAL TOLERANCES (UNLESS SPECIFIED)		DIMENSION STYLE		SCALE	DESIGN UNITS	THIRD ANGLE PROJECTION		
			mm	INCH	MM ONLY	2:1	METRIC	⊙ □			
EC NO: IFC2013-0751	2012/11/21	▽=0	4 PLACES ±---	±---	DRAWN BY	DATE	TITLE	S05 SERIES INTERNAL THREAD			
DRW:NDJSHEA	2012/11/23	▽=0	3 PLACES ±---	±---	JOCONNOR	2011/05/11					
CHKD:DMAHER	2012/11/23		2 PLACES ±0.1	±---	CHECKED BY	DATE		MOLEX INCORPORATED			
APPR:STGRIFLIN	2012/12/05		1 PLACE ±0.2	±---	DMAHER	2011/05/11					
			ANGULAR ±---°		APPROVED BY	DATE		SD-121064-001			
					EFOLAN	2011/05/25					
			DRAFT WHERE APPLICABLE MUST REMAIN WITHIN DIMENSIONS		MATERIAL NO.			SHEET NO. 1 OF 2			
					SEE SHEET 2						
					SIZE		THIS DRAWING CONTAINS INFORMATION THAT IS PROPRIETARY TO MOLEX INCORPORATED AND SHOULD NOT BE USED WITHOUT WRITTEN PERMISSION				

PART No.	mPm PART No.	DESCRIPTION	CIRCUIT	VOLTAGE	INDICATOR
1210640155	S05207TA022	TYPE C 2P PG7 TRANSPARENT NBR FLAT GASKET	A0	24V	RED LED/LAMP
1210640159	S05207TA122	TYPE C 2P PG7 TRANSPARENT NBR FLAT GASKET	A1	24V	RED LED
1210640160	S05207TA142	TYPE C 2P PG7 TRANSPARENT NBR FLAT GASKET	A1	115V	RED LED
1210640161	S05207TA152	TYPE C 2P PG7 TRANSPARENT NBR FLAT GASKET	A1	230V	RED LED
1210641267	S05207TA1H2	TYPE C 2P PG7 TRANSPARENT NBR FLAT GASKET	A1	24V	AMBER LED
1210641318	S05207TA121	TYPE C 2P PG7 TRANSPARENT NBR PROFILE GASKET	A1	24V	RED LED
1210641485	S05207TA1B1	TYPE C 2P PG7 TRANSPARENT NBR PROFILE GASKET	A1	24V	GREEN LED
1210641564	S05207TA1B2	TYPE C 2P PG7 TRANSPARENT NBR FLAT GASKET	A1	24V	GREEN LED
1210641565	S05207TA1E2	TYPE C 2P PG7 TRANSPARENT NBR FLAT GASKET	A1	230V	GREEN LED
1210641731	S05207TA1H1	TYPE C 2P PG7 TRANSPARENT NBR PROFILE GASKET	A1	24V	AMBER LED
1210641732	S05207TA1L1	TYPE C 2P PG7 TRANSPARENT NBR PROFILE GASKET	A1	115V	AMBER LED
1210641745	S05207TA1L2	TYPE C 2P PG7 TRANSPARENT NBR FLAT GASKET	A1	115V	AMBER LED
1210640164	S05207TC322	TYPE C 2P PG7 TRANSPARENT NBR FLAT GASKET	C3	24V	RED LED
1210640165	S05207TC3H1	TYPE C 2P PG7 TRANSPARENT NBR PROFILE GASKET	C3	24V	AMBER LED
1210641396	S05207TC321	TYPE C 2P PG7 TRANSPARENT NBR PROFILE GASKET	C3	24V	RED LED
1210641730	S05207TC3H2	TYPE C 2P PG7 TRANSPARENT NBR FLAT GASKET	C3	24V	AMBER LED
1210640167	S05207TC421	TYPE C 2P PG7 TRANSPARENT NBR PROFILE GASKET	C4	24V	RED LED
1210640168	S05207TC422	TYPE C 2P PG7 TRANSPARENT NBR FLAT GASKET	C4	24V	RED LED
1210640169	S05207TC4225N	TYPE C 2P PG7 TRANSPARENT NBR FLAT GASKET IN BOX OF 200	C4	24V	RED LED
1210640171	S05207TC442	TYPE C 2P PG7 TRANSPARENT NBR FLAT GASKET	C4	115V	RED LED
1210640172	S05207TC452	TYPE C 2P PG7 TRANSPARENT NBR FLAT GASKET	C4	230V	RED LED
1210640173	S05207TC4B2	TYPE C 2P PG7 TRANSPARENT NBR FLAT GASKET	C4	24V	GREEN LED
1210640175	S05207TC4D2	TYPE C 2P PG7 TRANSPARENT NBR FLAT GASKET	C4	115V	GREEN LED
1210640179	S05207TC4H2	TYPE C 2P PG7 TRANSPARENT NBR FLAT GASKET	C4	24V	AMBER LED
1210640181	S05207TC4L2	TYPE C 2P PG7 TRANSPARENT NBR FLAT GASKET	C4	115V	AMBER LED
1210640182	S05207TC4M2	TYPE C 2P PG7 TRANSPARENT NBR FLAT GASKET	C4	230V	AMBER LED
1210641245	S05207TC4B1	TYPE C 2P PG7 TRANSPARENT NBR PROFILE GASKET	C4	24V	GREEN LED
1210641253	S05207TC4H1	TYPE C 2P PG7 TRANSPARENT NBR PROFILE GASKET	C4	24V	AMBER LED
1210641446	S05207TC4M1	TYPE C 2P PG7 TRANSPARENT NBR PROFILE GASKET	C4	230V	AMBER LED
1210641459	S05207TC4Z4	TYPE C 2P PG7 TRANSPARENT WHITE SILICON FLAT GASKET	C4	24V	RED LED
1210641486	S052M2TC4B1	TYPE C 2P M12x1.5 TRANSPARENT NBR PROFILE GASKET	C4	24V	GREEN LED
1210641751	S05207TC4K2	TYPE C 2P PG7 TRANSPARENT NBR FLAT GASKET	C4	48V	AMBER LED
1210650105	S05207TC42214	TYPE C 2P PG7 TRANSPARENT NBR FLAT GASKET IN NEUTRAL BAG	C4	24V	RED LED
1210650552	S05207TC4525N	TYPE C 2P PG7 TRANSPARENT NBR FLAT GASKET IN BOX OF 200	C4	230V	RED LED
1210640183	S05207TS0H1	TYPE C 2P PG7 TRANSPARENT NBR PROFILE GASKET	S0	24V	AMBER LED
1210641799	S052M2TC322	TYPE C 2P M12x1.5 TRANSPARENT NBR FLAT GASKET	C3	24V	RED LED

SEE SHEET 1 EC NO: IPG2013-0751 DRWNG:JSHEA 2012/11/21 CHKD:DMAHER 2012/11/23 APPR:SGRIFFIN 2012/12/05	QUALITY SYMBOLS  = 0  = 0.1  = 0.2	GENERAL TOLERANCES (UNLESS SPECIFIED) <table border="1"> <tr><th></th><th>mm</th><th>INCH</th></tr> <tr><td>4 PLACES</td><td>± 0.1</td><td>± 0.004</td></tr> <tr><td>3 PLACES</td><td>± 0.15</td><td>± 0.006</td></tr> <tr><td>2 PLACES</td><td>± 0.2</td><td>± 0.008</td></tr> <tr><td>1 PLACE</td><td>± 0.25</td><td>± 0.010</td></tr> <tr><td>ANGULAR</td><td>± 0.2°</td><td>± 0.008°</td></tr> </table>			mm	INCH	4 PLACES	± 0.1	± 0.004	3 PLACES	± 0.15	± 0.006	2 PLACES	± 0.2	± 0.008	1 PLACE	± 0.25	± 0.010	ANGULAR	± 0.2°	± 0.008°	DIMENSION STYLE MM ONLY	SCALE 2:1	DESIGN UNITS METRIC	 THIRD ANGLE PROJECTION
			mm	INCH																					
		4 PLACES	± 0.1	± 0.004																					
		3 PLACES	± 0.15	± 0.006																					
2 PLACES	± 0.2	± 0.008																							
1 PLACE	± 0.25	± 0.010																							
ANGULAR	± 0.2°	± 0.008°																							
DRAWN BY JOCONNOR		DATE 2011/05/11		TITLE S05 SERIES INTERNAL THREAD																					
CHECKED BY DMAHER		DATE 2011/05/11		 MOLEX INCORPORATED																					
APPROVED BY EFOLAN		DATE 2011/05/25		MATERIAL NO. SD-121064-001		SHEET NO. 2 OF 2																			
DRAFT WHERE APPLICABLE MUST REMAIN WITHIN DIMENSIONS				SEE CHART THIS DRAWING CONTAINS INFORMATION THAT IS PROPRIETARY TO MOLEX INCORPORATED AND SHOULD NOT BE USED WITHOUT WRITTEN PERMISSION																					

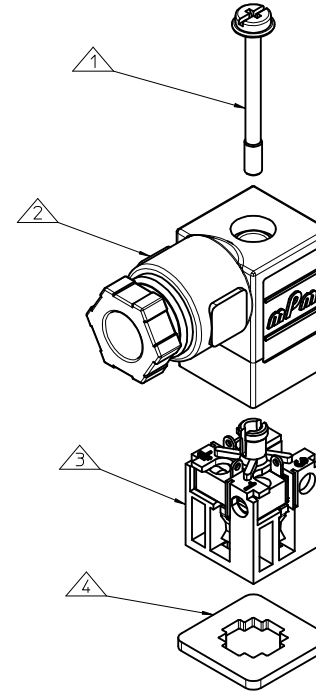
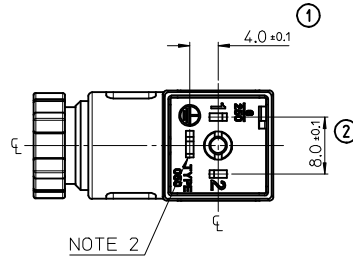
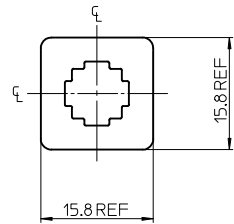
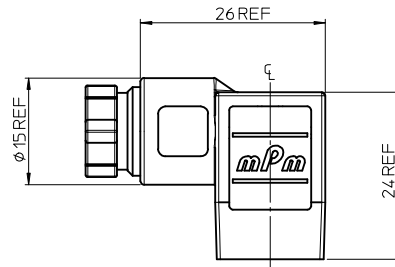
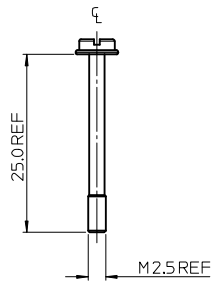
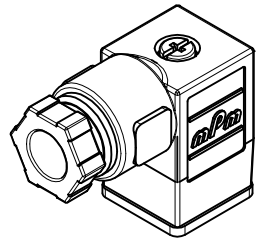

ITEM	DESCRIPTION
1	SCREW
2	COVER ASSEMBLY
3	INSERT ASSEMBLY
4	GASKET

S05207TA122**

SERIES
 S05= INTERNAL THREAD FORM C
 POLES
 2= 2 POLE & 3= 3 POLE
 THREAD
 07= PG7, M2= M12x15
 MATERIAL AND HOUSING COLOUR
 G= PA6 GRAY, N= PA6 BLACK, W= PA6 BLACK V0, T= TRANSPARENT
 CIRCUIT
 SEE DETAILS IN CATALOGUE
 VOLTAGE
 SEE DETAILS IN CATALOGUE
 SCREW AND GASKET
 1= NBR PROFILE GASKET & SCREW
 2= NBR FLAT GASKET & SCREW
 3= WHITE SILICON PROFILE GASKET & SCREW
 4= WHITE SILICON FLAT GASKET & SCREW
 NON STANDARD COMPONENTS
 14= PACKED IN NEUTRAL BAG
 5N= PACKED IN BOXES OF 200





NOTES

- PLEASE SEE SHEET 2 FOR CURRENTLY CONFIGURED PART NUMBERS. FOR SPECIFIC PART NUMBERS PLEASE CONTACT SALES OR CONSULT THE INTELLIGENT PART NUMBERS IN THE TABLE ATTACHED.
- EARTH POSITION SHOWN, H6.
- FOR PACKAGING SEE PACKAGING SPEC PK-121065-S05
- PRODUCT SPEC: SEE PS-121201-001

LAST INSPECTION NUMBER 2

ADDED PART NUMBER	DESCRIPTION	QUALITY SYMBOLS	GENERAL TOLERANCES (UNLESS SPECIFIED)		DIMENSION STYLE		SCALE	DESIGN UNITS	THIRD ANGLE PROJECTION		
			mm	INCH	MM ONLY	2:1	METRIC	PROJECTION			
EC NO: IFC2013-0751	2012/11/21	▽=0	4 PLACES ±---	±---	DRAWN BY	DATE	TITLE	S05 SERIES INTERNAL THREAD			
DRW:NDJSHEA	2012/11/23	▽=0	3 PLACES ±---	±---	JOCONNOR	2011/05/11					
CHKD:DMAHER	2012/11/23		2 PLACES ±0.1	±---	CHECKED BY	DATE		MOLEX INCORPORATED			
APPR:STGRIFLIN	2012/12/05		1 PLACE ±0.2	±---	DMAHER	2011/05/11					
			ANGULAR ±---°		APPROVED BY	DATE		SD-121064-001			
					EFOLAN	2011/05/25					
			DRAFT WHERE APPLICABLE MUST REMAIN WITHIN DIMENSIONS		MATERIAL NO.			SHEET NO. 1 OF 2			
					SEE SHEET 2						
					SIZE		THIS DRAWING CONTAINS INFORMATION THAT IS PROPRIETARY TO MOLEX INCORPORATED AND SHOULD NOT BE USED WITHOUT WRITTEN PERMISSION				

PART No.	mPm PART No.	DESCRIPTION	CIRCUIT	VOLTAGE	INDICATOR
1210640155	S05207TA022	TYPE C 2P PG7 TRANSPARENT NBR FLAT GASKET	A0	24V	RED LED/LAMP
1210640159	S05207TA122	TYPE C 2P PG7 TRANSPARENT NBR FLAT GASKET	A1	24V	RED LED
1210640160	S05207TA142	TYPE C 2P PG7 TRANSPARENT NBR FLAT GASKET	A1	115V	RED LED
1210640161	S05207TA152	TYPE C 2P PG7 TRANSPARENT NBR FLAT GASKET	A1	230V	RED LED
1210641267	S05207TA1H2	TYPE C 2P PG7 TRANSPARENT NBR FLAT GASKET	A1	24V	AMBER LED
1210641318	S05207TA121	TYPE C 2P PG7 TRANSPARENT NBR PROFILE GASKET	A1	24V	RED LED
1210641485	S05207TA1B1	TYPE C 2P PG7 TRANSPARENT NBR PROFILE GASKET	A1	24V	GREEN LED
1210641564	S05207TA1B2	TYPE C 2P PG7 TRANSPARENT NBR FLAT GASKET	A1	24V	GREEN LED
1210641565	S05207TA1E2	TYPE C 2P PG7 TRANSPARENT NBR FLAT GASKET	A1	230V	GREEN LED
1210641731	S05207TA1H1	TYPE C 2P PG7 TRANSPARENT NBR PROFILE GASKET	A1	24V	AMBER LED
1210641732	S05207TA1L1	TYPE C 2P PG7 TRANSPARENT NBR PROFILE GASKET	A1	115V	AMBER LED
1210641745	S05207TA1L2	TYPE C 2P PG7 TRANSPARENT NBR FLAT GASKET	A1	115V	AMBER LED
1210640164	S05207TC322	TYPE C 2P PG7 TRANSPARENT NBR FLAT GASKET	C3	24V	RED LED
1210640165	S05207TC3H1	TYPE C 2P PG7 TRANSPARENT NBR PROFILE GASKET	C3	24V	AMBER LED
1210641396	S05207TC321	TYPE C 2P PG7 TRANSPARENT NBR PROFILE GASKET	C3	24V	RED LED
1210641730	S05207TC3H2	TYPE C 2P PG7 TRANSPARENT NBR FLAT GASKET	C3	24V	AMBER LED
1210640167	S05207TC421	TYPE C 2P PG7 TRANSPARENT NBR PROFILE GASKET	C4	24V	RED LED
1210640168	S05207TC422	TYPE C 2P PG7 TRANSPARENT NBR FLAT GASKET	C4	24V	RED LED
1210640169	S05207TC4225N	TYPE C 2P PG7 TRANSPARENT NBR FLAT GASKET IN BOX OF 200	C4	24V	RED LED
1210640171	S05207TC442	TYPE C 2P PG7 TRANSPARENT NBR FLAT GASKET	C4	115V	RED LED
1210640172	S05207TC452	TYPE C 2P PG7 TRANSPARENT NBR FLAT GASKET	C4	230V	RED LED
1210640173	S05207TC4B2	TYPE C 2P PG7 TRANSPARENT NBR FLAT GASKET	C4	24V	GREEN LED
1210640175	S05207TC4D2	TYPE C 2P PG7 TRANSPARENT NBR FLAT GASKET	C4	115V	GREEN LED
1210640179	S05207TC4H2	TYPE C 2P PG7 TRANSPARENT NBR FLAT GASKET	C4	24V	AMBER LED
1210640181	S05207TC4L2	TYPE C 2P PG7 TRANSPARENT NBR FLAT GASKET	C4	115V	AMBER LED
1210640182	S05207TC4M2	TYPE C 2P PG7 TRANSPARENT NBR FLAT GASKET	C4	230V	AMBER LED
1210641245	S05207TC4B1	TYPE C 2P PG7 TRANSPARENT NBR PROFILE GASKET	C4	24V	GREEN LED
1210641253	S05207TC4H1	TYPE C 2P PG7 TRANSPARENT NBR PROFILE GASKET	C4	24V	AMBER LED
1210641446	S05207TC4M1	TYPE C 2P PG7 TRANSPARENT NBR PROFILE GASKET	C4	230V	AMBER LED
1210641459	S05207TC4Z4	TYPE C 2P PG7 TRANSPARENT WHITE SILICON FLAT GASKET	C4	24V	RED LED
1210641486	S052M2TC4B1	TYPE C 2P M12x1.5 TRANSPARENT NBR PROFILE GASKET	C4	24V	GREEN LED
1210641751	S05207TC4K2	TYPE C 2P PG7 TRANSPARENT NBR FLAT GASKET	C4	48V	AMBER LED
1210650105	S05207TC42214	TYPE C 2P PG7 TRANSPARENT NBR FLAT GASKET IN NEUTRAL BAG	C4	24V	RED LED
1210650552	S05207TC4525N	TYPE C 2P PG7 TRANSPARENT NBR FLAT GASKET IN BOX OF 200	C4	230V	RED LED
1210640183	S05207TS0H1	TYPE C 2P PG7 TRANSPARENT NBR PROFILE GASKET	S0	24V	AMBER LED
1210641799	S052M2TC322	TYPE C 2P M12x1.5 TRANSPARENT NBR FLAT GASKET	C3	24V	RED LED

SEE SHEET 1 EC NO: IPG2013-0751 DRWNG:JSHEA 2012/11/21 CHKD:DMAHER 2012/11/23 APPR:STGRIFIN 2012/12/05	QUALITY SYMBOLS  = 0  = 0.1  = 0.2	GENERAL TOLERANCES (UNLESS SPECIFIED) <table border="1"> <tr> <th></th> <th>mm</th> <th>INCH</th> </tr> <tr> <td>4 PLACES</td> <td>± 0.15</td> <td>± 0.006</td> </tr> <tr> <td>3 PLACES</td> <td>± 0.2</td> <td>± 0.008</td> </tr> <tr> <td>2 PLACES</td> <td>± 0.3</td> <td>± 0.012</td> </tr> <tr> <td>1 PLACE</td> <td>± 0.5</td> <td>± 0.020</td> </tr> <tr> <td colspan="3">ANGULAR ± 0.5°</td> </tr> </table>			mm	INCH	4 PLACES	± 0.15	± 0.006	3 PLACES	± 0.2	± 0.008	2 PLACES	± 0.3	± 0.012	1 PLACE	± 0.5	± 0.020	ANGULAR ± 0.5°			DIMENSION STYLE MM ONLY	SCALE 2:1	DESIGN UNITS METRIC	 THIRD ANGLE PROJECTION
			mm	INCH																					
		4 PLACES	± 0.15	± 0.006																					
		3 PLACES	± 0.2	± 0.008																					
2 PLACES	± 0.3	± 0.012																							
1 PLACE	± 0.5	± 0.020																							
ANGULAR ± 0.5°																									
DRAWN BY JOCONNOR		DATE 2011/05/11	TITLE S05 SERIES INTERNAL THREAD																						
CHECKED BY DMAHER		DATE 2011/05/11	MOLEX INCORPORATED																						
APPROVED BY EFOLAN		DATE 2011/05/25	MATERIAL NO. SEE CHART		DOCUMENT NO. SD-121064-001	SHEET NO. 2 OF 2																			

DRAFT WHERE APPLICABLE MUST REMAIN WITHIN DIMENSIONS

THIS DRAWING CONTAINS INFORMATION THAT IS PROPRIETARY TO MOLEX INCORPORATED AND SHOULD NOT BE USED WITHOUT WRITTEN PERMISSION