



FEATURES

- UL 60950 recognised
- 4:1 wide range voltage input
- Operating temperature range -40°C to 85°C with derating
- 1.5 kVDC Isolation 'Hi Pot Test'
- 3.3V, 5V, 12V & 15V outputs
- No electrolytic capacitors
- Continuous short circuit protection

PRODUCT OVERVIEW

The NCS3 series of DC-DC converters offers a single output voltage from input voltage ranges of 9-36V and 18-80V. The NCS3 is housed in an industry standard package with a standard pinout.

Applications include telecommunications, battery powered systems, process control and distributed power systems.

SELECTION GUIDE

Order Code	Input Voltage	Output Voltage	Minimum Load	Rated Input Current 12V or 48V Input.	Rated Input Current 24V Input.	Output Current	Efficiency 12V or 48V Input.		Efficiency 24V Input.		Ripple and Noise		MTTF ¹ kHrs
	Nom.						Min.	Typ.	Min.	Typ.	Typ.	Max.	
	V	V					%	%	%	%	mVp/p	mVp/p	
NCS3S1203SC	12	3.3	10	250	125	700	74	77	73	76	32	55	1335
NCS3S1205SC	12	5	5	305	150	600	79	82	79	81	34	60	1081
NCS3S1212SC	12	12	0	300	150	250	81	84	80	83	28	55	1272
NCS3S1215SC	12	15	0	300	150	200	82	86	81	85	20	50	1617
NCS3S4803SC	48	3.3	10	124	65	700	70	74	74	77	22	55	1327
NCS3S4805SC	48	5	5	153	80	600	77.5	80	79	81	36	75	1117
NCS3S4812SC	48	12	0	150	80	250	77	81	80	83	31	65	1211
NCS3S4815SC	48	15	0	149	80	200	78	81	81	83	22	55	1574

INPUT CHARACTERISTICS

Parameter	Conditions	Min.	Typ.	Max.	Units
Voltage range	12V input types	9	12	36	V
	48V input types	18	48	80	
Input reflected ripple current	NCS3S12XX	12V input	5.5		mA P-P
		24V input	2		
	NCS3S48XX	24V input	3.5		
		48V input	2		
Power consumption at shutdown			2	mW	
Input current in shutdown				2.5	mA

OUTPUT CHARACTERISTICS

Parameter	Conditions	Min.	Typ.	Max.	Units
Rated power	3.3V output types			2.31	W
	All other output types			3	
Voltage set point accuracy	All output types		±1	±2	%
Line regulation	Low line to high line			±0.5	%
Load regulation	All output types			±1	%
Transient response	Peak deviation (12.5-37.5% & 37.5-12.5% swing)			5	%V _{out}
	Settling time (within 5% V _{out} Nom.)		1.5		ms

ISOLATION CHARACTERISTICS

Parameter	Conditions	Min.	Typ.	Max.	Units
Isolation test voltage	Flash tested for 1 minute	1500			VDC
Isolation Capacitance	NCS3S12XXSC		180		pF
	NCS3S48XXSC		185		
Resistance	Viso = 1kVDC	1			GΩ

GENERAL CHARACTERISTICS

Parameter	Conditions	Min.	Typ.	Max.	Units
CTRL input current	Please refer to control pin application note	2		8	mA

TEMPERATURE CHARACTERISTICS

Parameter	Conditions	Min.	Typ.	Max.	Units
Operation	See derating graphs	-40		85	°C
Storage		-50		115	
Case temperature rise above ambient	100% Load, Nom V _{in} , Still Air		30	40	

¹ Calculated using MIL-HDBK-217 FN2, parts stress method with nominal input voltage at full load.
All specifications typical at TA=25°C, nominal input voltage and rated output current unless otherwise specified.



For full details go to
<https://www.murata.com/en-global/products/power/rohs>

ABSOLUTE MAXIMUM RATINGS

Short-circuit protection (for SELV input voltages)	Continuous
Control pin input current	8mA
Lead temperature 1.0mm from case for 10 seconds (to JEDEC JESD22-B106 ISS C)	260°C
Wave Solder	Wave Solder profile not to exceed the profile recommended in IEC 61760-1 Section 6.1.3. Please refer to application notes for further information.
Input voltage, NCS3 12V input types	40V
Input voltage, NCS3 48V input types for 100ms	100V

SWITCHING FREQUENCY

Parameter	Conditions	Min.	Typ.	Max.	Units
NCS3S1203SC	12V input types	10% Load	1200		kHz
		100% Load	280		
	24V input types	10% Load	1620		
		100% Load	460		
NCS3S1205SC	12V input types	10% Load	1200		kHz
		100% Load	270		
	24V input types	10% Load	1690		
		100% Load	490		
NCS3S1212SC	12V input types	10% Load	1220		kHz
		100% Load	310		
	24V input types	10% Load	1680		
		100% Load	570		
NCS3S1215SC	12V input types	10% Load	1130		kHz
		100% Load	310		
	24V input types	10% Load	1580		
		100% Load	570		
NCS3S4803SC	24V input types	10% Load	1020		kHz
		100% Load	270		
	48V input types	10% Load	1440		
		100% Load	450		
NCS3S4805SC	24V input types	10% Load	1190		kHz
		100% Load	260		
	48V input types	10% Load	1590		
		100% Load	470		
NCS3S4812SC	24V input types	10% Load	1180		kHz
		100% Load	1570		
	48V input types	10% Load	310		
		100% Load	560		
NCS3S4815SC	24V input types	10% Load	1180		kHz
		100% Load	330		
	48V input types	10% Load	1590		
		100% Load	610		

TECHNICAL NOTES

ISOLATION VOLTAGE

'Hi Pot Test', 'Flash Tested', 'Withstand Voltage', 'Proof Voltage', 'Dielectric Withstand Voltage' & 'Isolation Test Voltage' are all terms that relate to the same thing, a test voltage, applied for a specified time, across a component designed to provide electrical isolation, to verify the integrity of that isolation.

Murata Power Solutions NCS3 series of DC-DC converters are all 100% production tested at their stated isolation voltage. This is 1.5kVDC for 60 seconds.

A question commonly asked is, "What is the continuous voltage that can be applied across the part in normal operation?"

The NCS3 has been recognised by Underwriters Laboratory for functional isolation. Both input and output should normally be maintained within SELV limits i.e. less than 42.4V peak, or 60VDC. The isolation test voltage represents a measure of immunity to transient voltages and the part should never be used as an element of a safety isolation system. The part could be expected to function correctly with several hundred volts offset applied continuously across the isolation barrier; but then the circuitry on both sides of the barrier must be regarded as operating at an unsafe voltage and further isolation/insulation systems must form a barrier between these circuits and any user-accessible circuitry according to safety standard requirements.

REPEATED HIGH-VOLTAGE ISOLATION TESTING

It is well known that repeated high-voltage isolation testing of a barrier component can actually degrade isolation capability, to a lesser or greater degree depending on materials, construction and environment. The NCS3 series has a toroid core, with no additional insulation between primary and secondary windings of enamelled wire. While parts can be expected to withstand several times the stated test voltage, the isolation capability does depend on the wire insulation. Any material, including this enamel (typically polyurethane) is susceptible to eventual chemical degradation when subject to very high applied voltages thus implying that the number of tests should be strictly limited. We therefore strongly advise against repeated high voltage isolation testing, but if it is absolutely required, that the voltage be reduced by 20% from specified test voltage.

This consideration equally applies to agency recognised parts rated for better than functional isolation where the wire enamel insulation is always supplemented by a further insulation system of physical spacing or barriers.

SAFETY APPROVAL

UL60950

The NCS3 series has been recognised by Underwriters Laboratory (UL) to UL 60950 for functional insulation, file number E151252 applies. The NCS3 Series of converters are not internally fused so to meet the requirements of UL 60950 an anti-surge input line fuse should always be used with ratings as defined below.

NCS3S12XXSC: 0.75A
NCS3S48XXSC: 0.50A

CE AND UKCA MARKING

The CE and UKCA markings are only applicable to NCS3S48XXSC variants.

All fuses should be UL approved and rated to at least the maximum allowable DC input voltage.

RoHS COMPLIANCE INFORMATION



This series is compatible with RoHS soldering systems with a peak wave solder temperature of 260°C for 10 seconds. Please refer to [application notes](#) for further information. The pin termination finish on this product series is Tin Plate, Hot Dipped over Matte Tin with Nickel Preplate. The series is backward compatible with Sn/Pb soldering systems.

PART NUMBER STRUCTURE

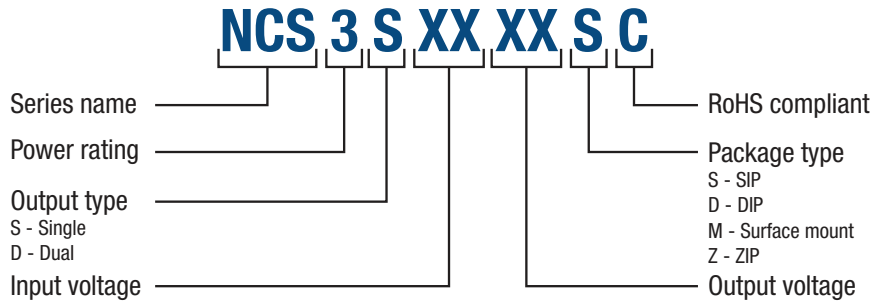

CHARACTERISATION TEST METHODS

Ripple & Noise Characterisation Method

Ripple and noise measurements are performed with the following test configuration.

C1	1µF X7R multilayer ceramic capacitor, voltage rating to be a minimum of 3 times the output voltage of the DC-DC converter
C2	10µF tantalum capacitor, voltage rating to be a minimum of 1.5 times the output voltage of the DC-DC converter with an ESR of less than 100mΩ at 100 kHz
C3	100nF multilayer ceramic capacitor, general purpose
R1	450Ω resistor, carbon film, ±1% tolerance
R2	50Ω BNC termination
T1	3T of the coax cable through a ferrite toroid
RLOAD	Resistive load to the maximum power rating of the DC-DC converter. Connections should be made via twisted wires

Measured values are multiplied by 10 to obtain the specified values.

Differential Mode Noise Test Schematic

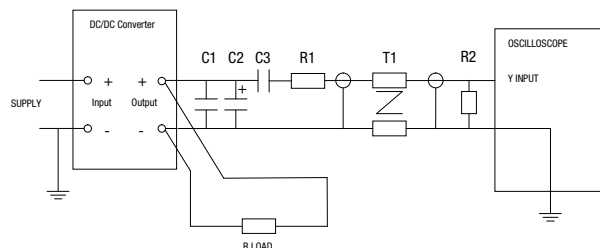

APPLICATION NOTES

Recommended Input Capacitor and Maximum Output Capacitance

A 10 µF output capacitor is recommended for stability under all operating conditions. Maximum output capacitance should not exceed:

Output Voltage V	Maximum Load Capacitance µF
3.3	470
5	470
12	220
15	110

APPLICATION NOTES (Continued)

Start-up times

Typical start up times for this series, with a typical input voltage rise time of 2.2µs and output capacitance of 10µF, are shown in the table below. The product series will start into the maximum output capacitance with increased start times.

Part No.	Start-up times
	ms
NCS3S1203SC	0.7
NCS3S1205SC	1
NCS3S1212SC	2.2
NCS3S1215SC	2.3
NCS3S4803SC	1.2
NCS3S4805SC	1.1
NCS3S4812SC	1.9
NCS3S4815SC	2.8

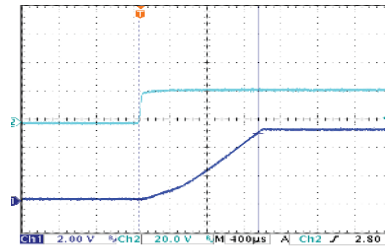

Typical Start-Up Wave Form

Control Pin

The NCS3S converters have a shutdown feature which enables the user to disable the converter into a low power state. The control pin connects to the base of an internal NPN transistor through a 1K resistor with the converter shut down when the transistor is turned on by an external applied voltage. The converter can also be shut down using a 5V TTL signal (the unit is OFF for logic High and ON for logic LOW). If the control pin is left open (high impedance), the converter will run normally. A suitable application circuit is shown below.

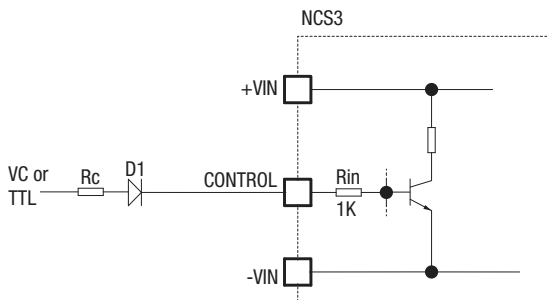

D1 (e.g. 1N4001) is necessary for correct operation of the NCS3 when the control signal is LOW. The recommended drive current I_b to shut down the NCS3 is 2 mA to 8 mA. The value of R_c can be derived as follows:

$$R_c = \frac{V_c - V_{D1} - 0.6 - (I_b \times R_{IN})}{I_b}$$

Note: R_{IN} is a 125mW resistor

For a switch input:

Calculate the value of R_c from the above equation given switch voltage V_c and chosen current between 2 and 8 mA.

For 5V TTL Signal:

Set R_c to be 680Ω or less.

EFFICIENCY VS LOAD

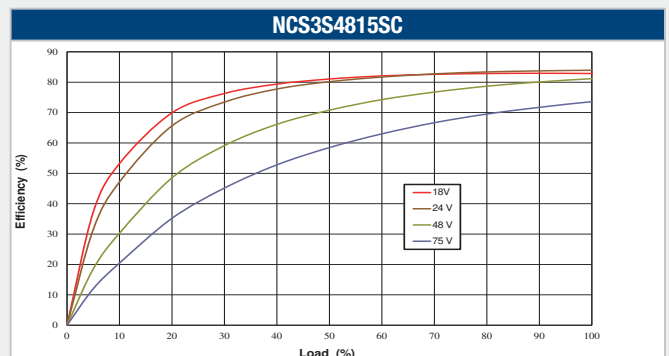
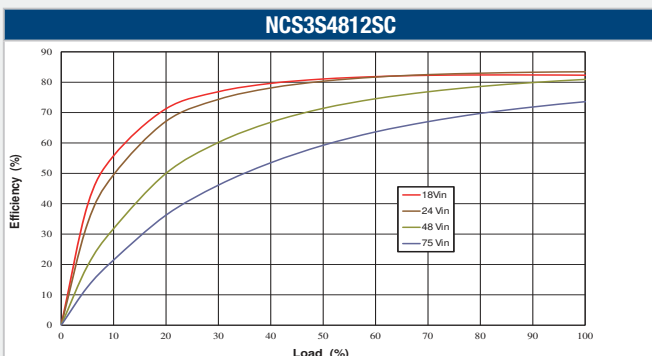
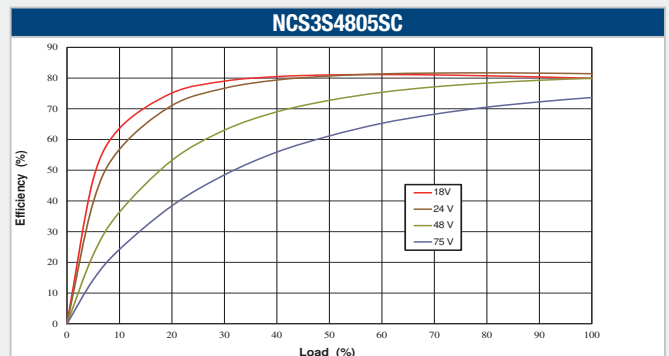
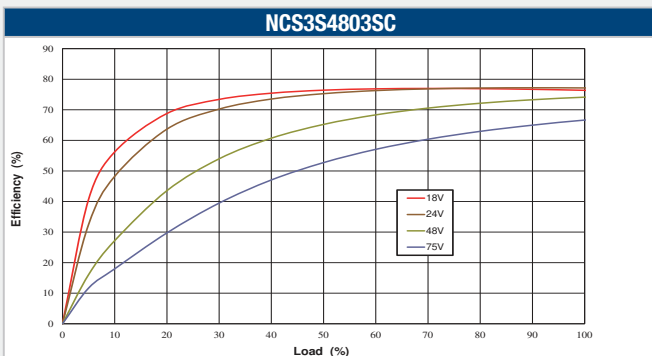
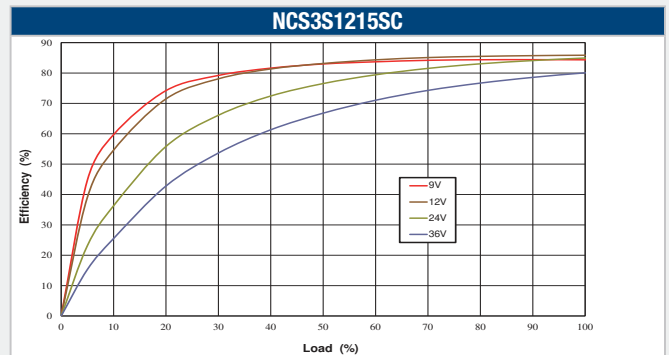
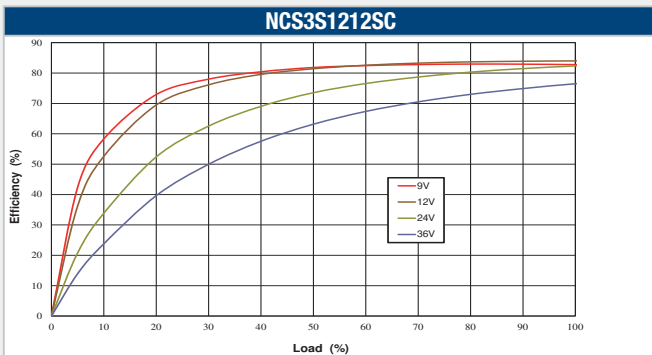
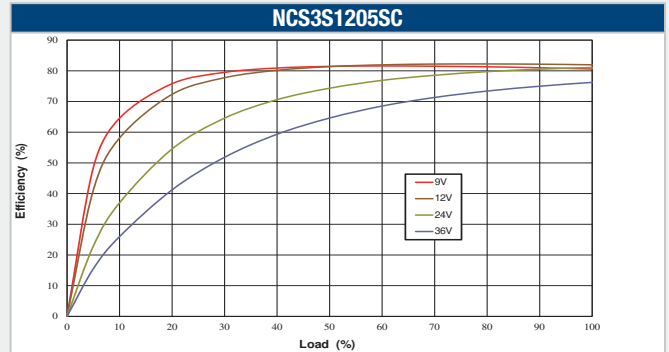
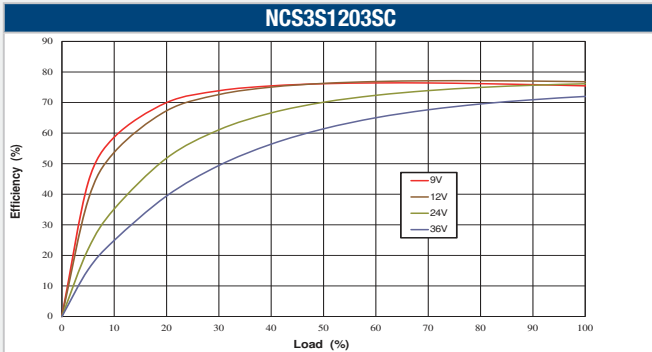

TEMPERATURE DERATING

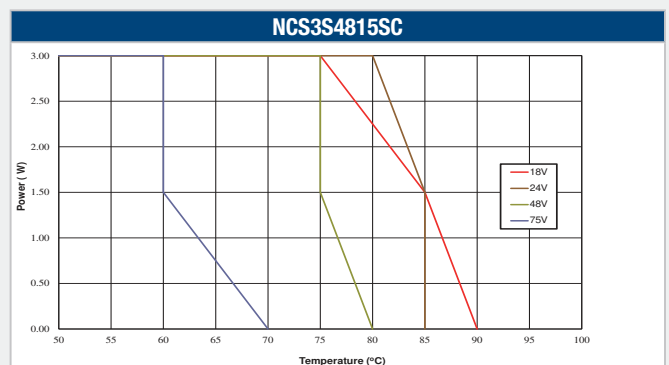
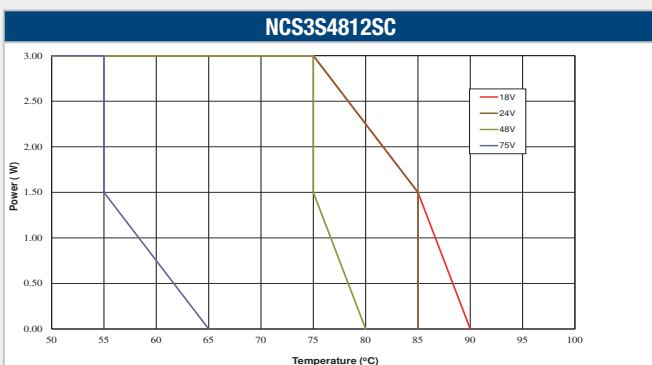
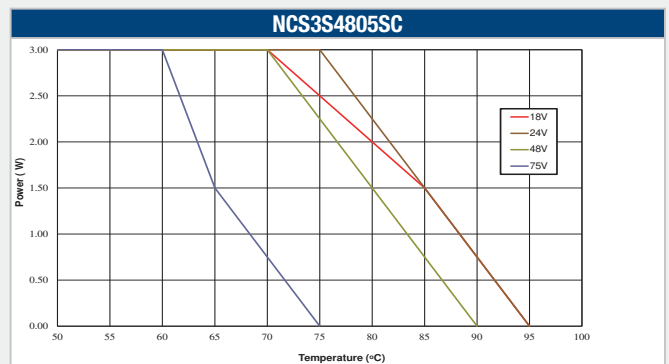
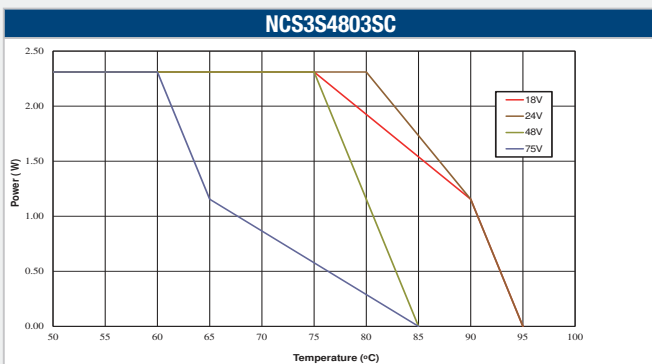
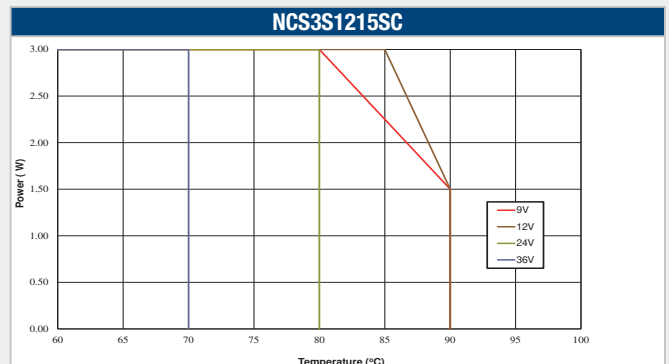
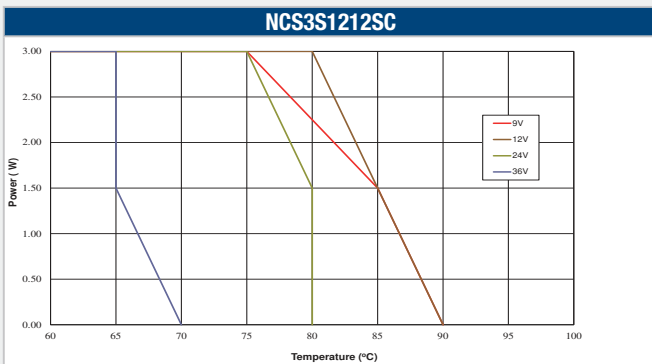
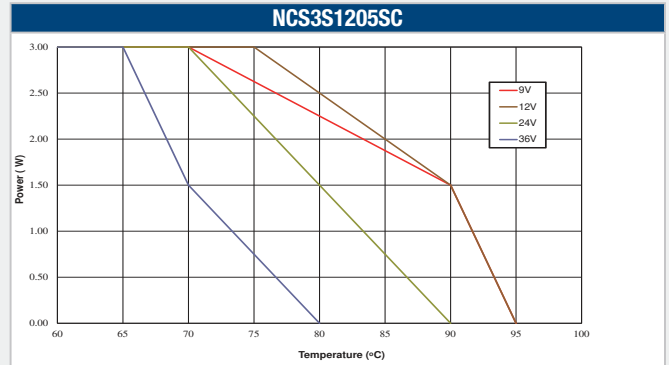
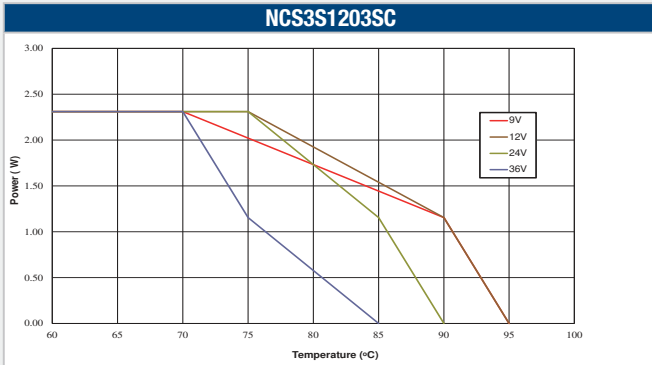

EMC FILTERING AND SPECTRA

FILTERING

The module includes a basic level of filtering, sufficient for many applications. Where lower noise levels are desired, filters can easily be added to achieve any required noise performance.

A DC-DC converter generates noise in two principal forms: that which is radiated from its body and that conducted on its external connections. There are three separate modes of conducted noise: input differential, output differential and input-output.

This last appears as common mode at the input and the output, and cannot therefore be removed by filtering at the input or output alone. The first level of filtering is to connect capacitors between input and output returns, to reduce this form of noise. It typically contains high harmonics of the switching frequency, which tend to appear as spikes on surrounding circuits. The voltage rating of this capacitor must match the required isolation voltage. (Due to the great variety in isolation voltage and required noise performance, this capacitor has not been included within the converter.)

Input ripple is a voltage developed across the internal Input decoupling capacitor. It is therefore measured with a defined supply source impedance. Although simple series inductance will provide filtering, on its own it can degrade the stability. A shunt capacitor is therefore recommended across the converter input terminals, so that it is fed from a low impedance.

If no filtering is required, the inductance of long supply wiring could also cause a problem, requiring an input decoupling capacitor for stability. An electrolytic will perform well in these situations. The input-output filtering is performed by the common-mode choke on the primary. This could be placed on the output, but would then degrade the regulation and produce less benefit for a given size, cost, and power loss.

Radiated noise is present in magnetic and electric forms. Thanks to the small size of these units, neither form of noise will be radiated "efficiently", so will not normally cause a problem. Any question of this kind usually better repays attention to conducted signals.

EMC FILTER AND VALUES TO OBTAIN SPECTRA AS SHOWN

The following filter circuit and filter table shows the input filters typically required to meet EN55022 Quasi-Peak Curve A or B.

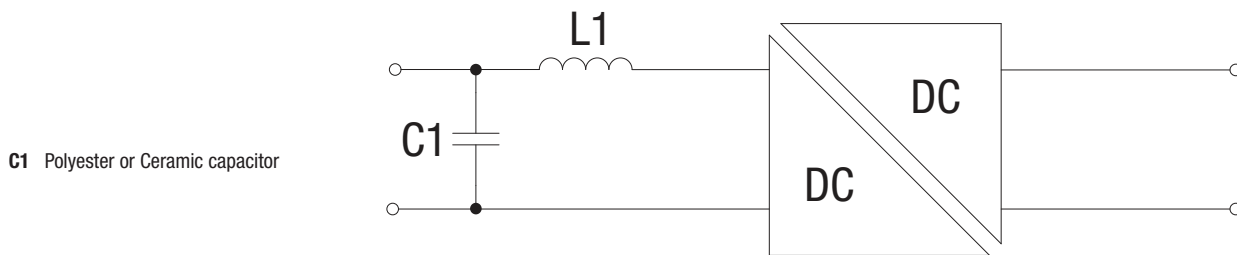

C1 Polyester or Ceramic capacitor

TO MEET CURVE A		
Part Number	C1	L1
NCS3S1203SC	2.2µF	3.3µH
NCS3S1205SC	2.2µF	3.3µH
NCS3S1212SC	1.5µF	3.3µH
NCS3S1215SC	1.5µF	3.3µH
NCS3S4803SC	4.7µF	3.3µH
NCS3S4805SC	4.7µF	3.3µH
NCS3S4812SC	4.7µF	3.3µH
NCS3S4815SC	4.7µF	3.3µH

TO MEET CURVE B		
Part Number	C1	L1
NCS3S1203SC	4.7µF	15µH
NCS3S1205SC	4.7µF	10µH
NCS3S1212SC	4.7µF	10µH
NCS3S1215SC	4.7µF	10µH
NCS3S4803SC	9.4µF	50µH
NCS3S4805SC	9.4µF	50µH
NCS3S4812SC	9.4µF	50µH
NCS3S4815SC	9.4µF	50µH

The following typical spectra are shown for class A and class B respectively with quasi peak and mean value limits.

EMC FILTERING AND SPECTRA (Continued)

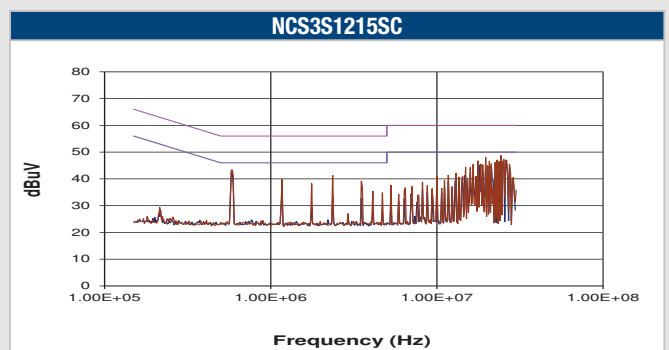
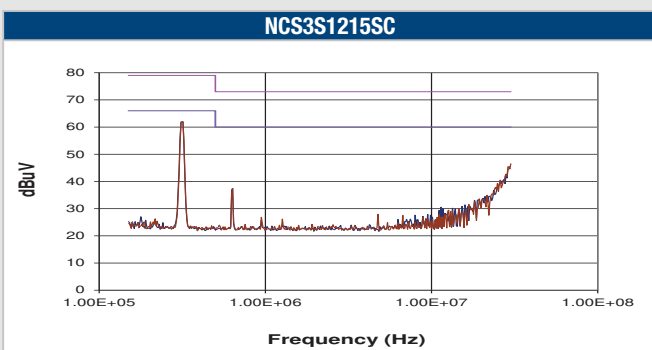
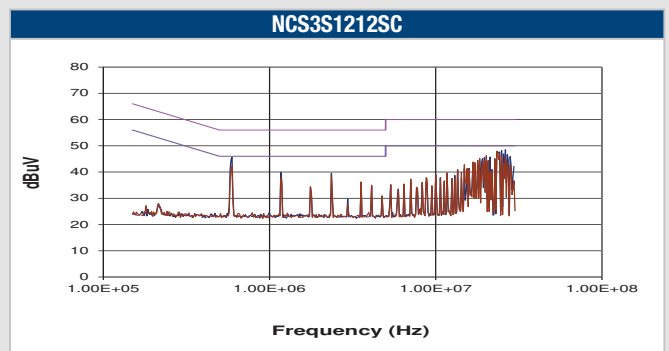
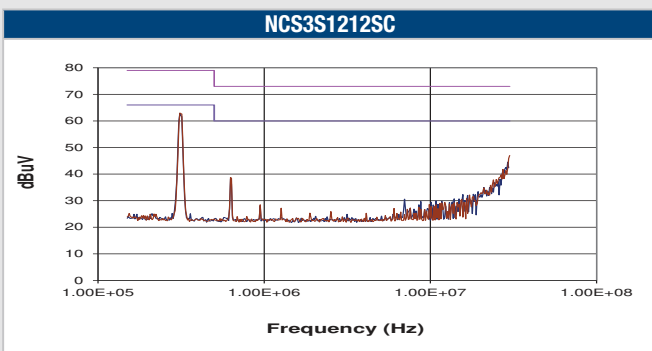
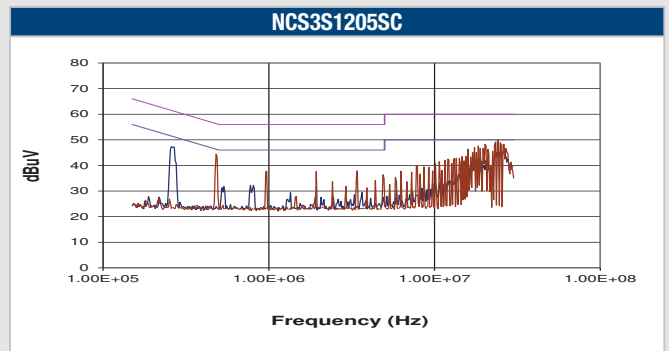
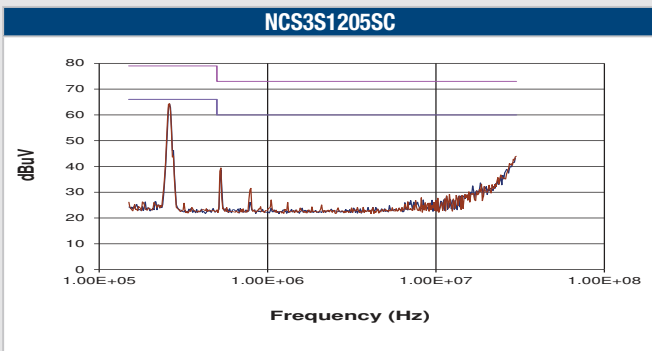
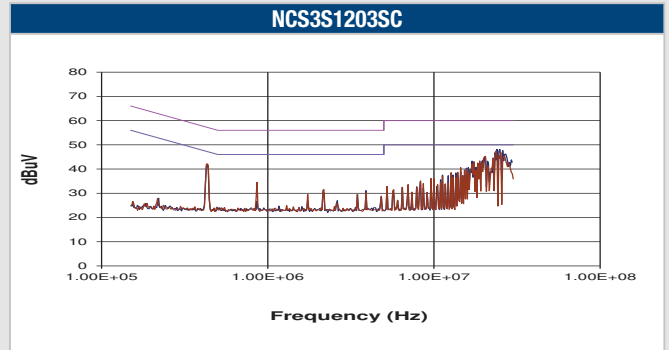
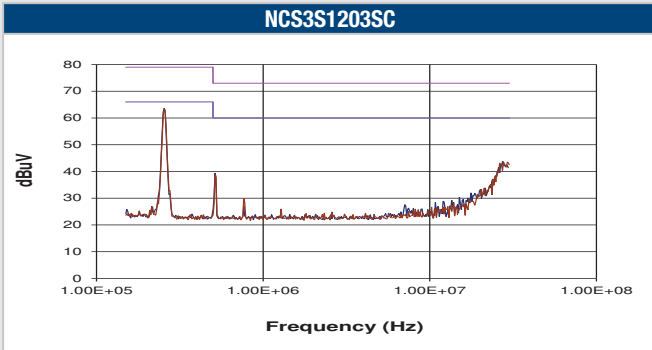

EMC FILTERING AND SPECTRA (Continued)

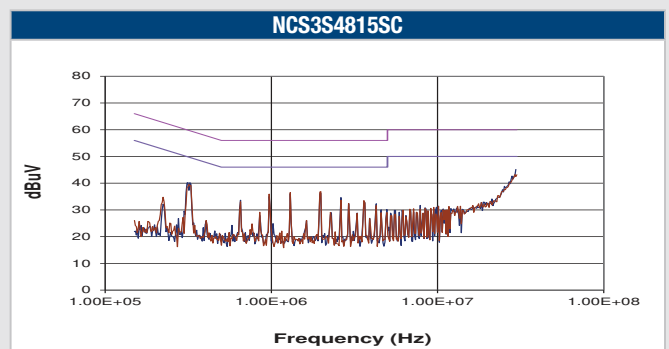
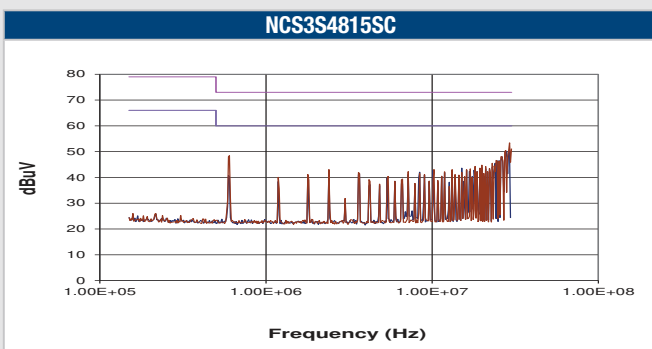
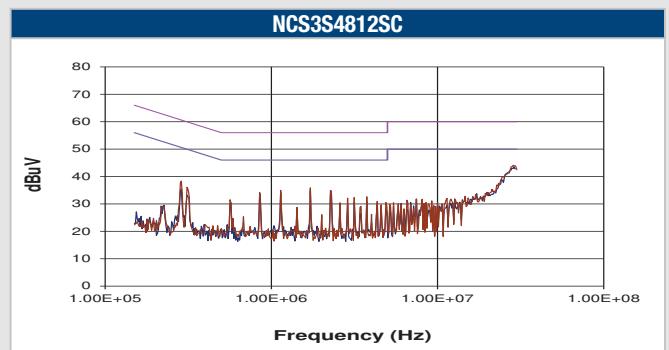
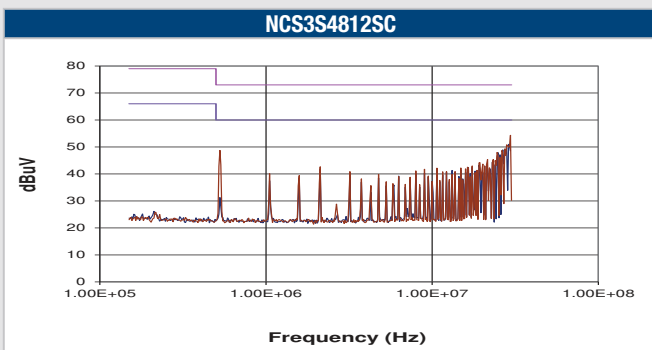
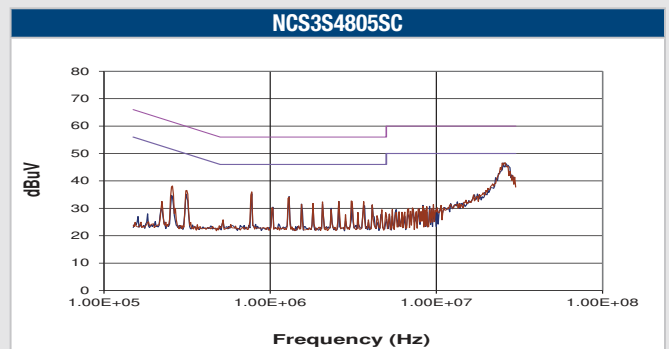
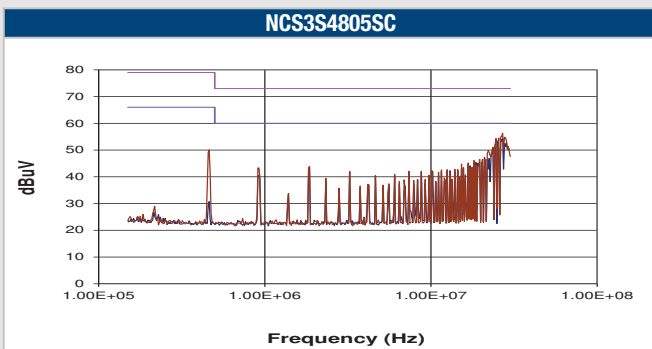
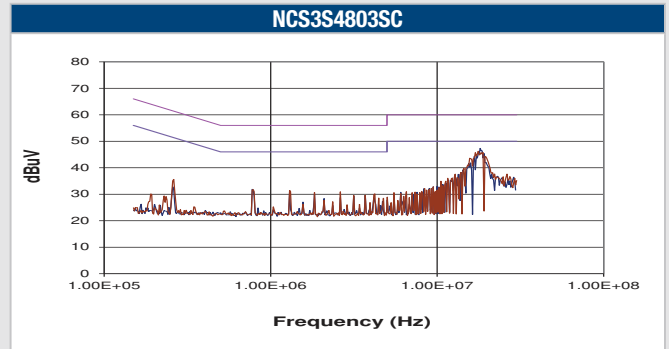
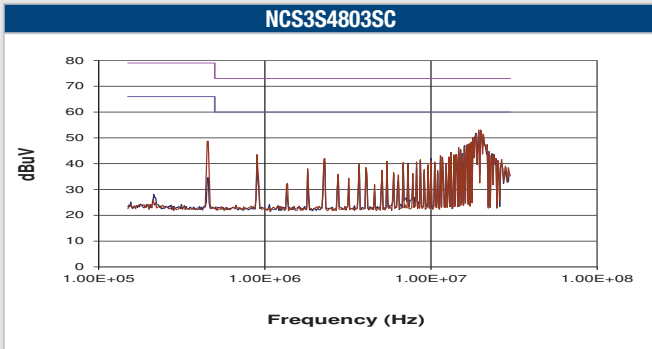

PACKAGE SPECIFICATIONS

MECHANICAL DIMENSIONS

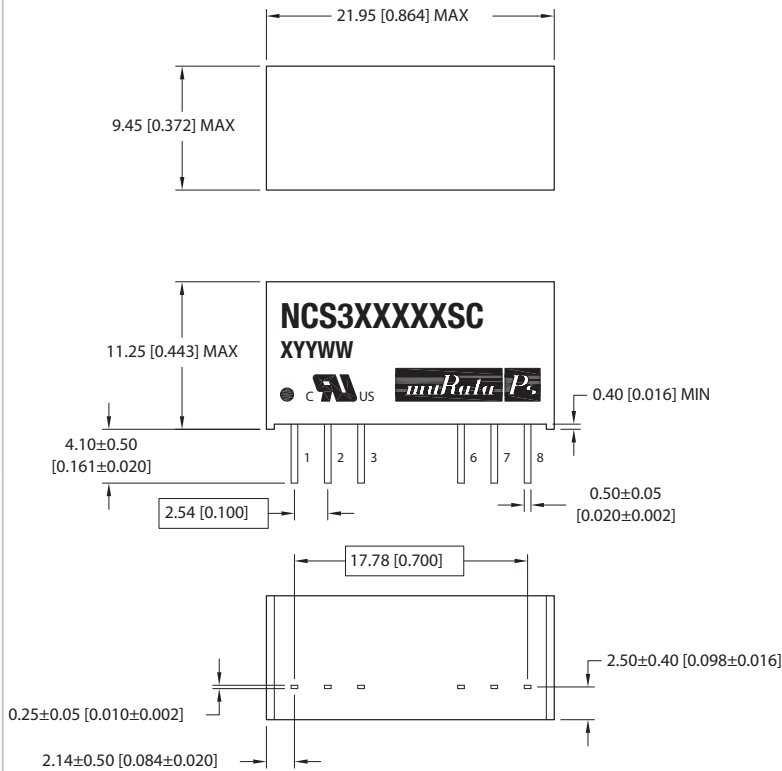

All dimensions in millimetres (inches), controlling dimension is mm.
All pins on a 2.54 (0.100) pitch and within 0.25 (0.010) of true position.

Weight: 4.4g

PIN CONNECTIONS

Pin	Function
	Single
1	-VIN
2	+VIN
3	Control
6	+VOUT
7	0V
8	N/C

TUBE OUTLINE DIMENSIONS

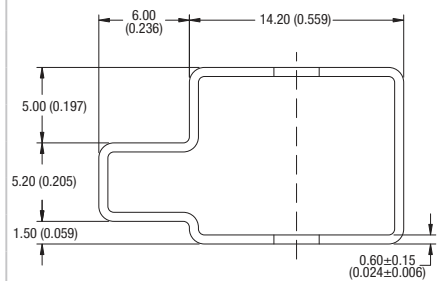

All dimensions in inches ± 0.01 (mm ± 0.5 mm).

Tube length : 20.47 \pm 0.079 (520mm \pm 2mm).

Tube Quantity : 23

RECOMMENDED FOOTPRINT DETAILS

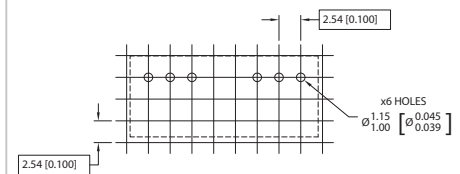

All dimensions in mm (inches) ± 0.25 (± 0.010).

DISCLAIMER

Unless otherwise stated in the datasheet, all products are designed for standard commercial and industrial applications and NOT for safety-critical and/or life-critical applications.

Particularly for safety-critical and/or life-critical applications, i.e. applications that may directly endanger or cause the loss of life, inflict bodily harm and/or loss or severe damage to equipment/property, and severely harm the environment, a prior explicit written approval from Murata is strictly required. Any use of Murata standard products for any safety-critical, life-critical or any related applications without any prior explicit written approval from Murata shall be deemed unauthorised use.

These applications include but are not limited to:

- Aircraft equipment
- Aerospace equipment
- Undersea equipment
- Power plant control equipment
- Medical equipment
- Transportation equipment (automobiles, trains, ships, etc.)
- Traffic signal equipment
- Disaster prevention / crime prevention equipment
- Data Processing equipment

Murata makes no express or implied warranty, representation, or guarantee of suitability, fitness for any particular use/purpose and/or compatibility with any application or device of the buyer, nor does Murata assume any liability whatsoever arising out of unauthorised use of any Murata product for the application of the buyer. The suitability, fitness for any particular use/purpose and/or compatibility of Murata product with any application or device of the buyer remain to be the responsibility and liability of the buyer.

Buyer represents and agrees that it has all the necessary expertise to create and implement safeguards that anticipate dangerous consequences of failures, monitor failures and their consequences, lessen the likelihood of failures that might cause harm, and take appropriate remedial actions. Buyer will fully indemnify and hold Murata, its affiliated companies, and its representatives harmless against any damages arising out of unauthorised use of any Murata products in any safety-critical and/or life-critical applications.

Remark: Murata in this section refers to Murata Manufacturing Company and its affiliated companies worldwide including, but not limited to, Murata Power Solutions.



This product is subject to the following [operating requirements](#) and the [Life and Safety Critical Application Sales Policy](#):

Refer to: <https://www.murata.com/en-eu/products/power/requirements>

Murata Power Solutions (Milton Keynes) Ltd. makes no representation that the use of its products in the circuits described herein, or the use of other technical information contained herein, will not infringe upon existing or future patent rights. The descriptions contained herein do not imply the granting of licenses to make, use, or sell equipment constructed in accordance therewith. Specifications are subject to change without notice. © 2022 Murata Power Solutions (Milton Keynes) Ltd.