



TAOGLAS®



Datasheet

HA.21.A

Description:

2dBi 868MHz

Embedded Helical Monopole Antenna

Features:

Quarter-wave Monopole Type Helical Antenna

868 MHz ISM Band

2dBi peak gain and 70% efficiency

Direct mounted on-board design

Mechanically sturdy in a compact size

Dimensions: 11mm, \varnothing 10.25mm

1mm diameter copper

RoHS & Reach Compliant

1. Introduction	3
2. Specifications	4
3. Antenna Characteristics	10
4. Radiation Patterns	15
5. Mechanical Drawing	17
6. Packaging	18
7. Application Note	19
<hr/>	
Changelog	20

Taoglas makes no warranties based on the accuracy or completeness of the contents of this document and reserves the right to make changes to specifications and product descriptions at any time without notice. Taoglas reserves all rights to this document and the information contained herein. Reproduction, use or disclosure to third parties without express permission is strictly prohibited.



1. Introduction



The HA.21.A is an ISM 868MHz quarter-wave monopole helical antenna. Small and compact, yet stable, this helical coil antenna is ideal for typical 868MHz applications such as:

- Smart Metering
- Smart security systems
- Remote asset monitoring and other wireless communication devices.

The helical coil antenna offers industry leading 70% efficiency at 868MHz on a 126.8 x 80.1mm ground plane, with matching components (orthogonally mounted to ground plane, see HAD.B.21 performance). Made of copper alloy, the helical coil is mechanically sturdy. It can be easily mounted on the surface by soldering. Since it is a monopole design, it must be connected to the main-board device ground-plane to radiate efficiently.

Taoglas has two models of evaluation boards, HAD.A.21 and HAD.B.21, to show performance when the antenna is parallel mounted, or orthogonally mounted to the ground plane.

Small embedded antennas can easily detune or lose efficiency on different board and in different device environments. Taoglas offers a testing and tuning service for custom antennas, subject to NRE and MOQ. For more information or installation instructions please contact your regional Taoglas customer service team.

2. Specifications

Electrical			
Frequency (MHz)	850	868	880
Peak Gain (dBi)			
HAD.A.21	0.76	0.77	0.27
HAD.B.21	1.79	1.83	1.64
Average Gain (dB)			
HAD.A.21	-2.82	-2.87	-3.35
HAD.B.21	-1.42	-1.49	-1.74
Efficiency (%)			
HAD.A.21	52.21	51.52	46.22
HAD.B.21	72.10	70.95	66.92
Return Loss(dB)	<-10		
Polarization	Linear		
Impedance	50Ω		
Mechanical			
Helical Coil Dimension	L: 11mm, Ø10.25mm		
Coil Diameter	1mm		
Weight	0.7g		
Environmental			
Humidity	Non-condensing 65°C 95% RH		
Temperature Range	-40°C to 85°C		

3. Antenna Characteristics

3.1 Return Loss

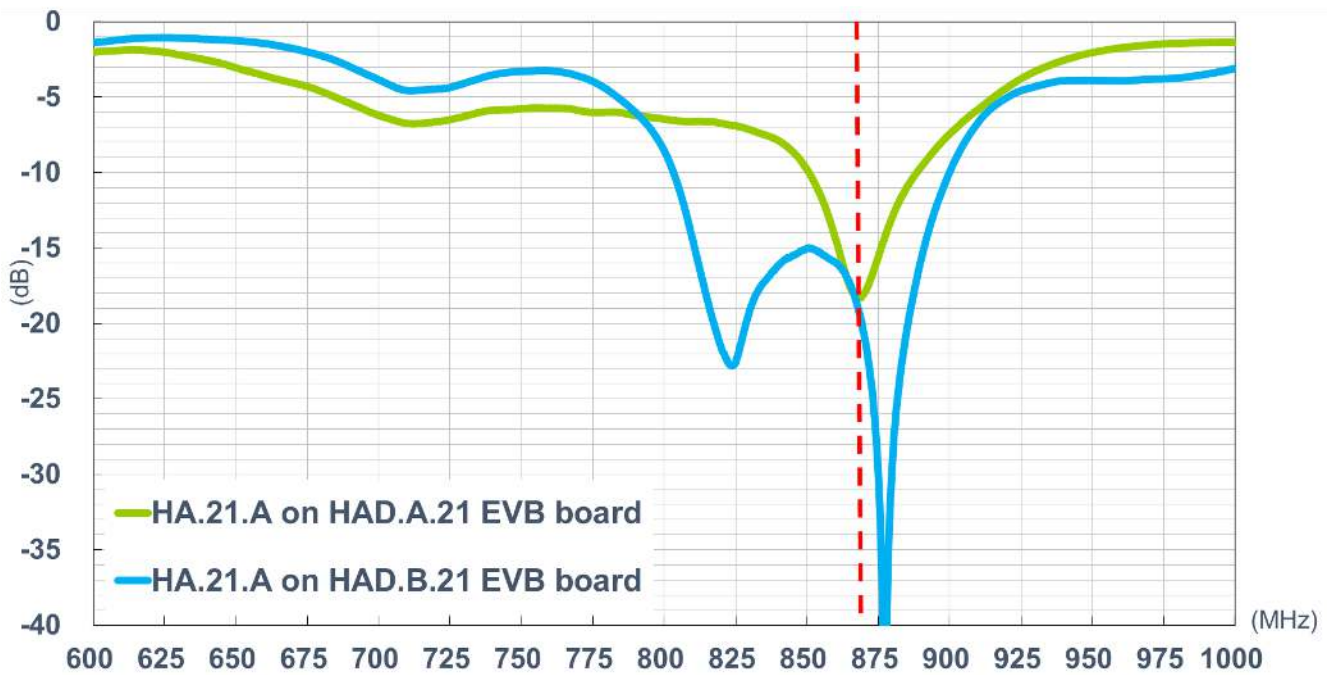

3.2 Efficiency

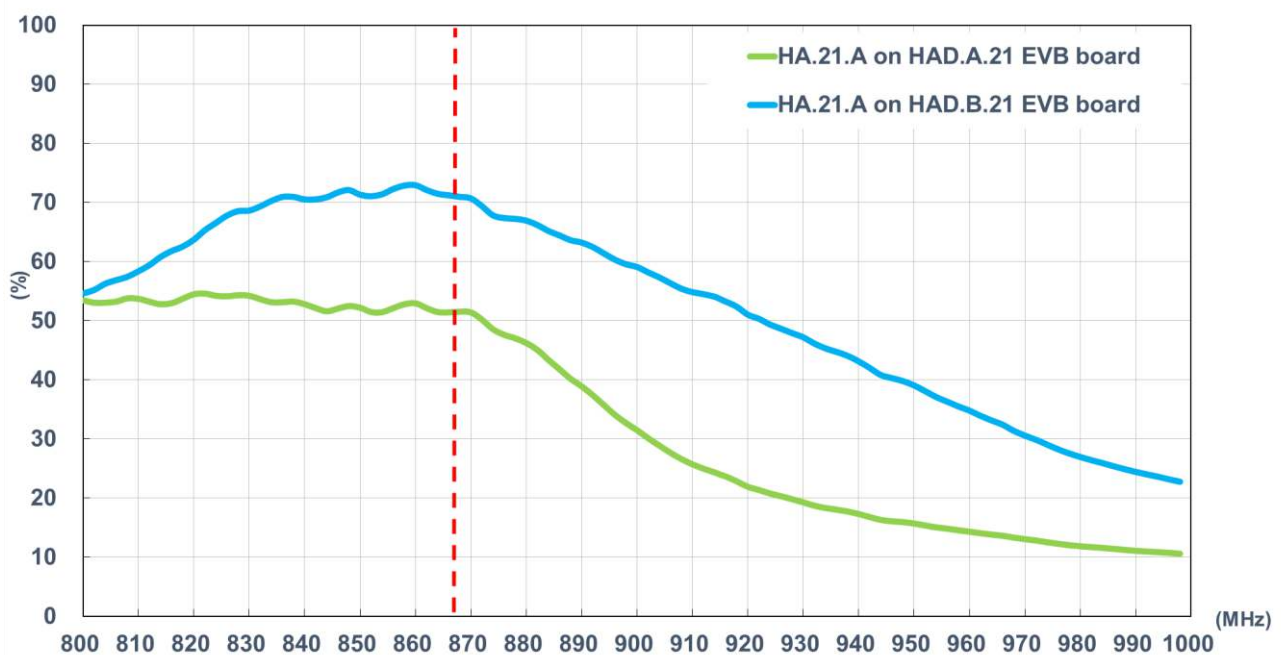

3.3 Average Gain

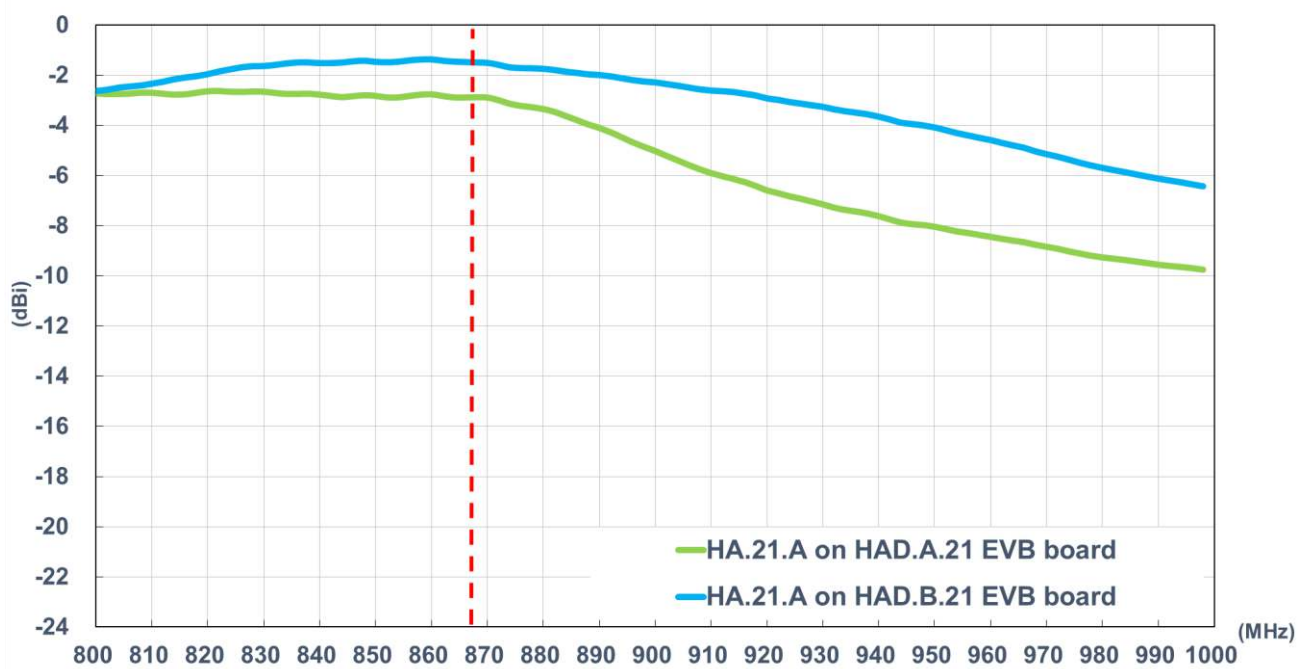

3.4 Peak Gain

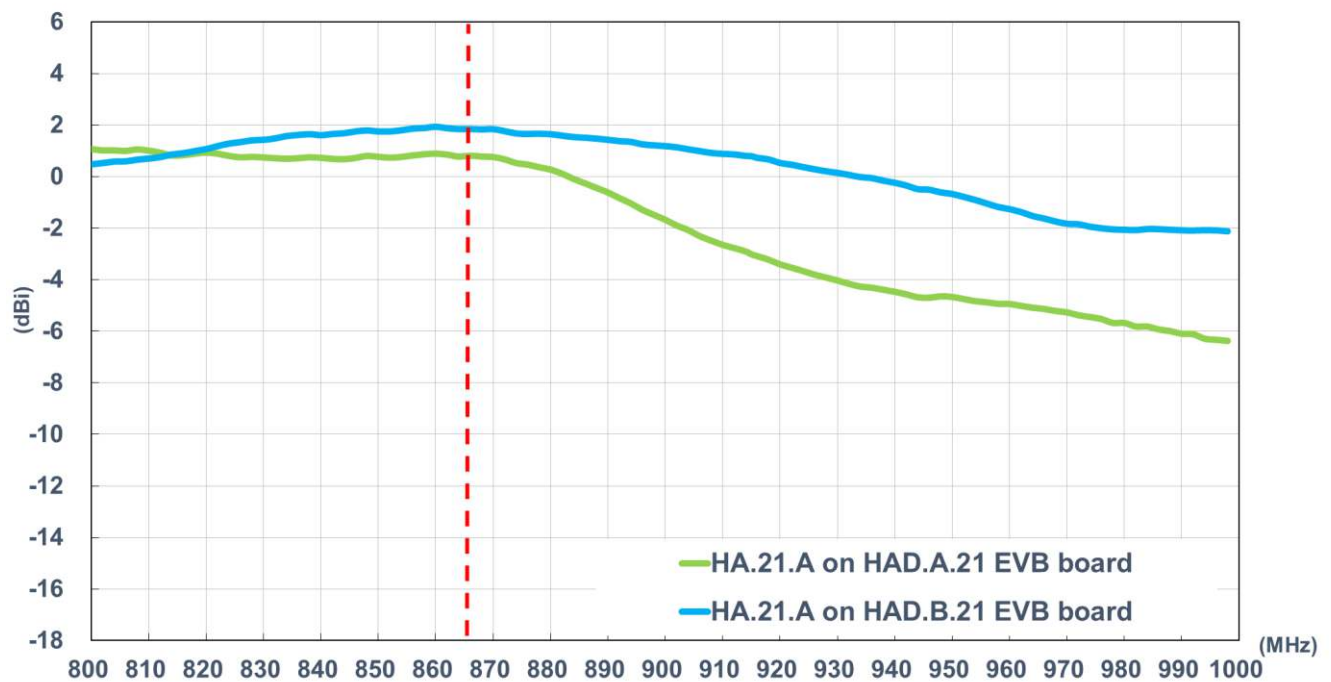

4. Radiation Patterns

4.1 Test Setup

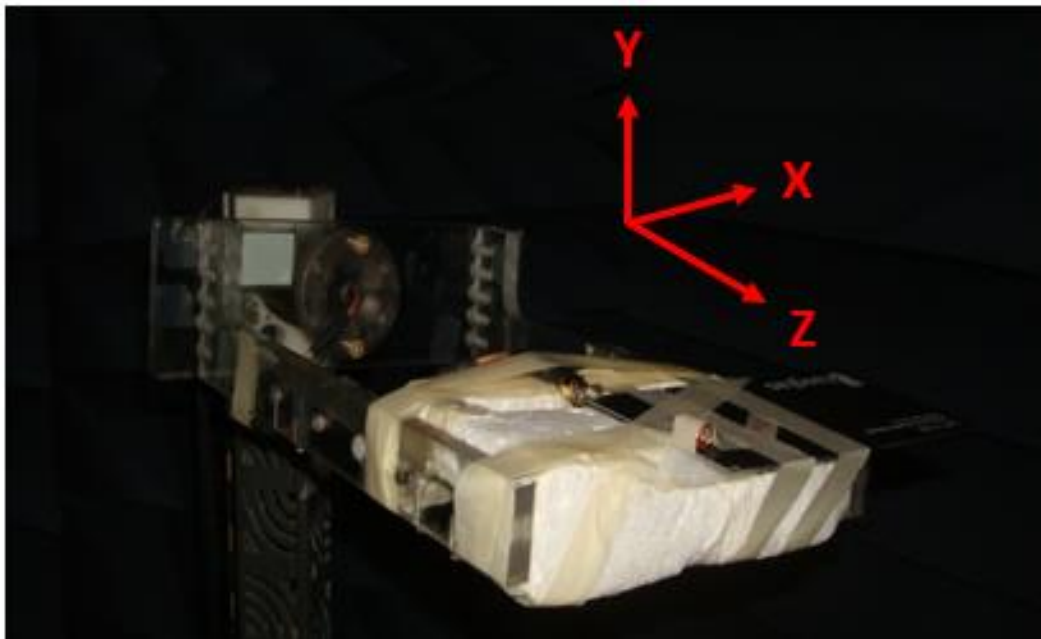

HAD.A.21 Evaluation Board

4.2 868MHz 3D and 2D Radiation Patterns

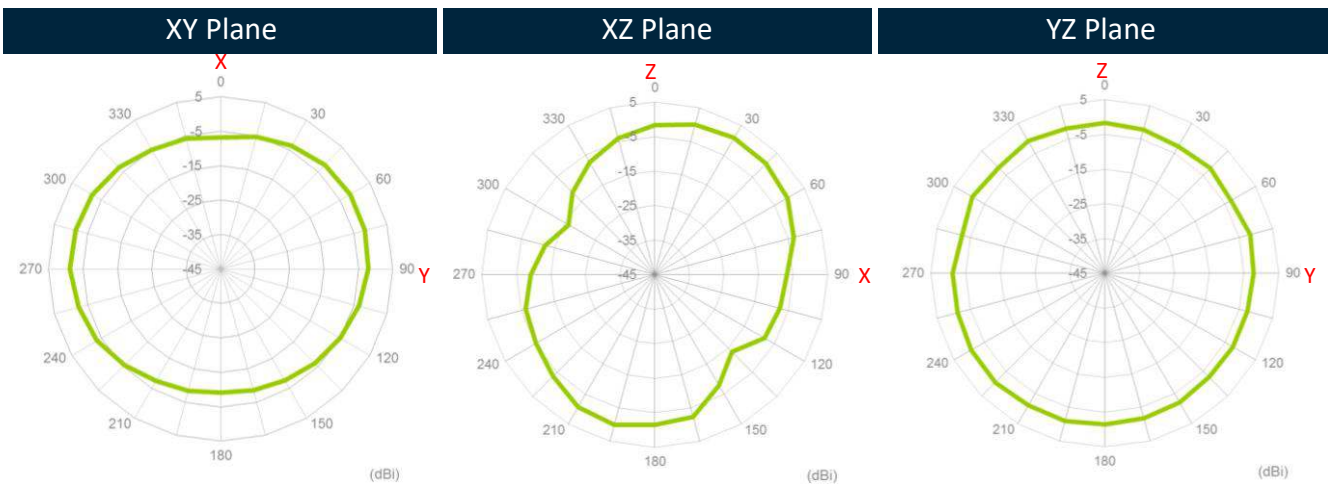
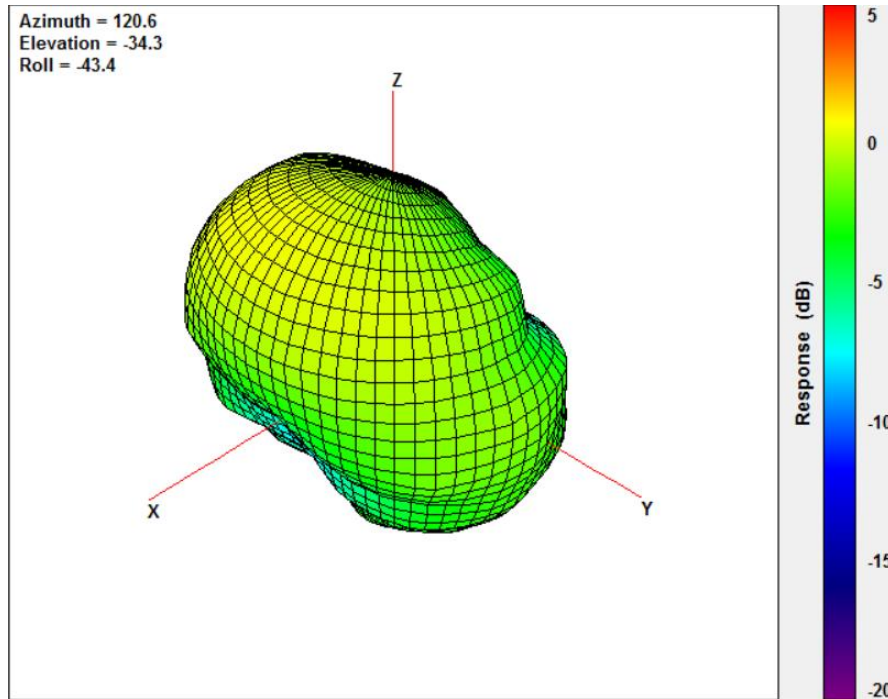

4.3 Test Setup

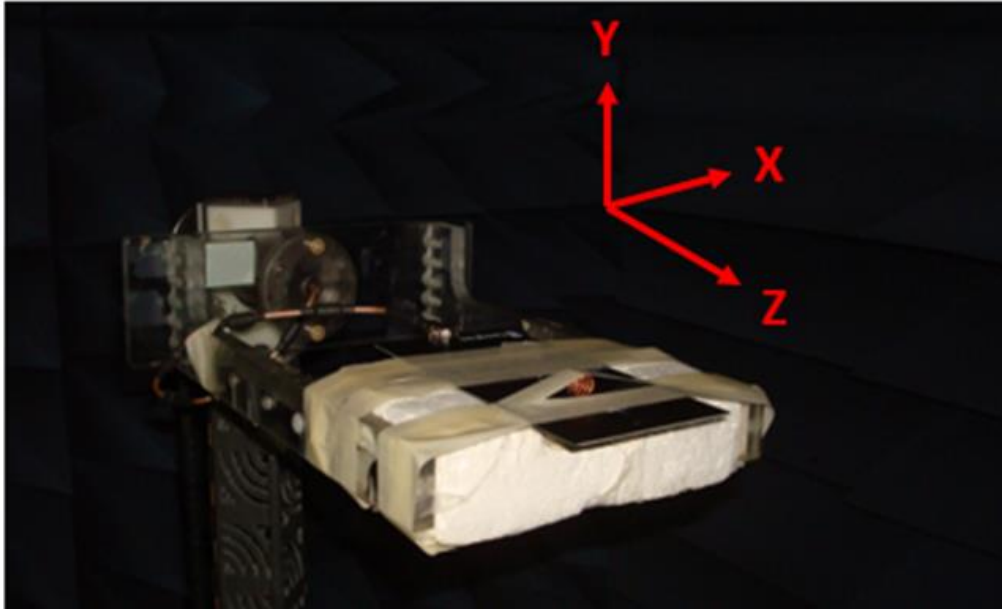

HAD.B.21 Evaluation Board

4.4 868MHz 3D and 2D Radiation Patterns

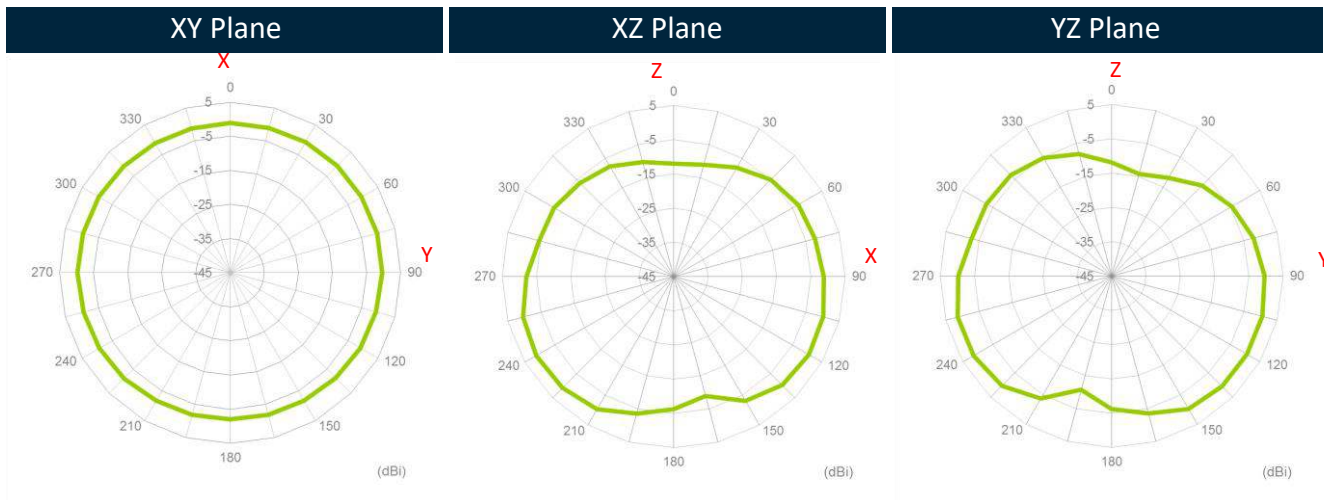
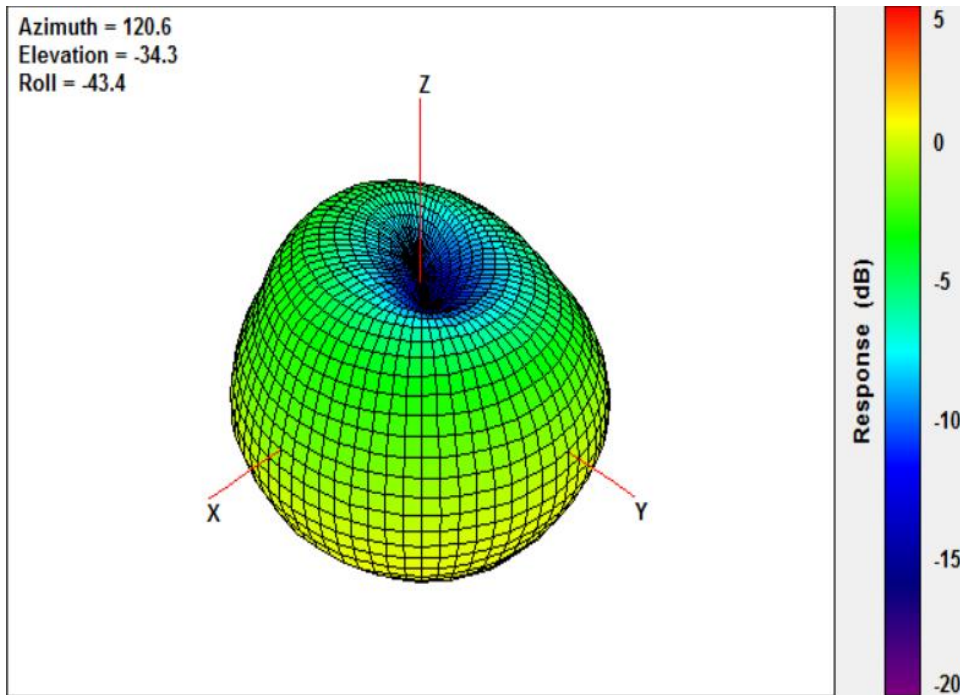

5. Mechanical Drawing (Units: mm)

5.1 Antenna Drawing

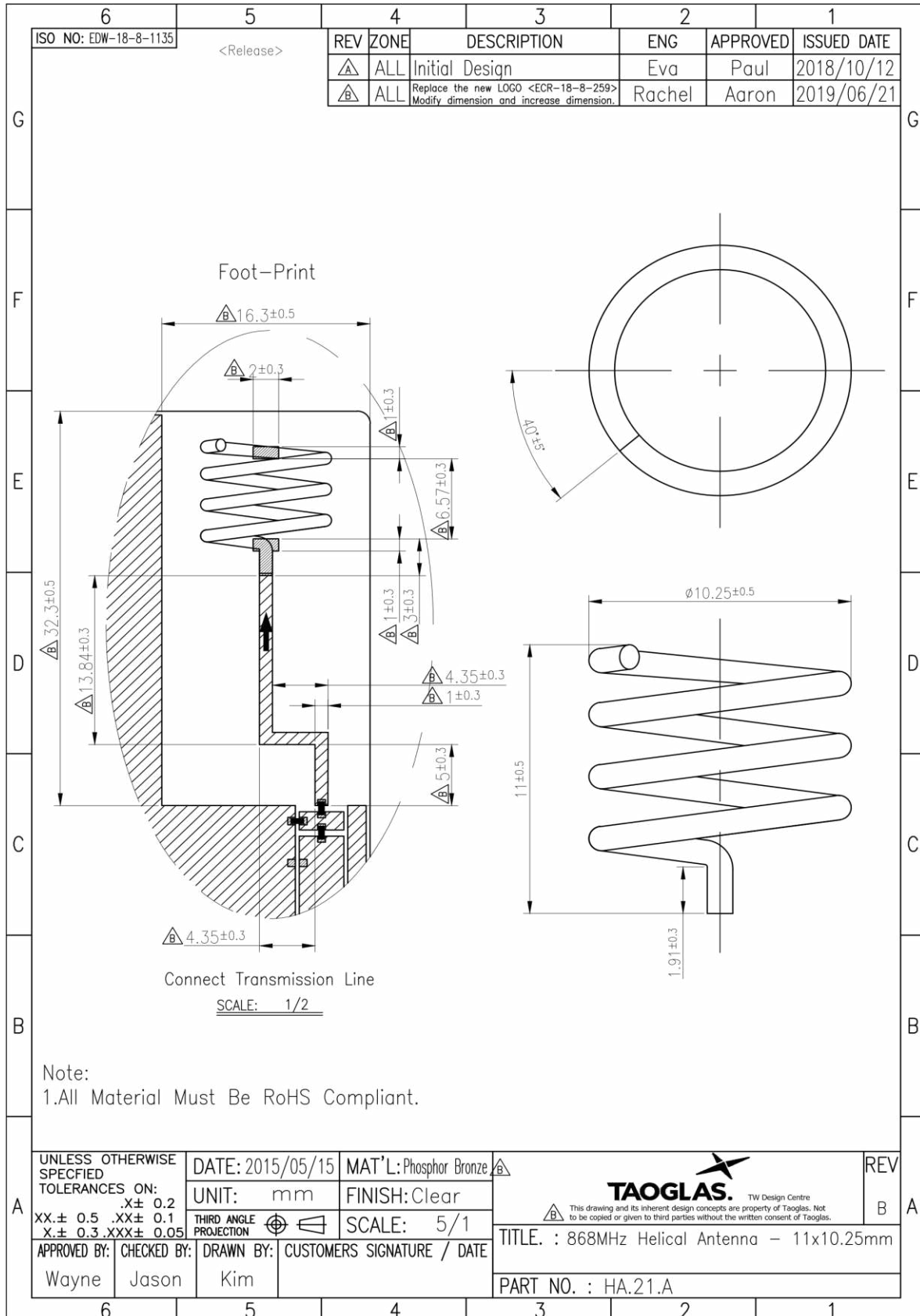

5.2 HAD.A.21 Evaluation Board Drawing

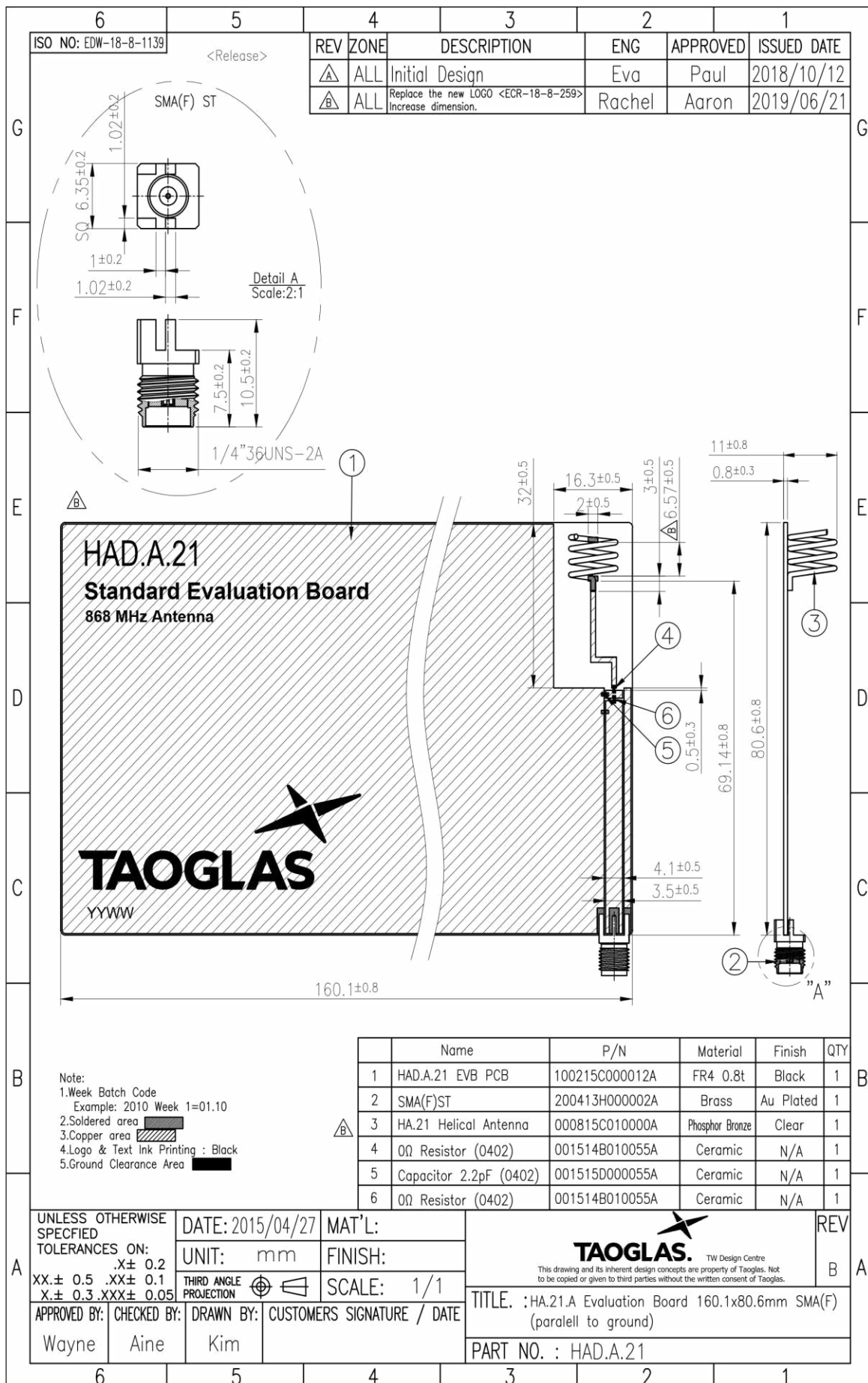

5.2 HAD.B.21 Evaluation Board Drawing

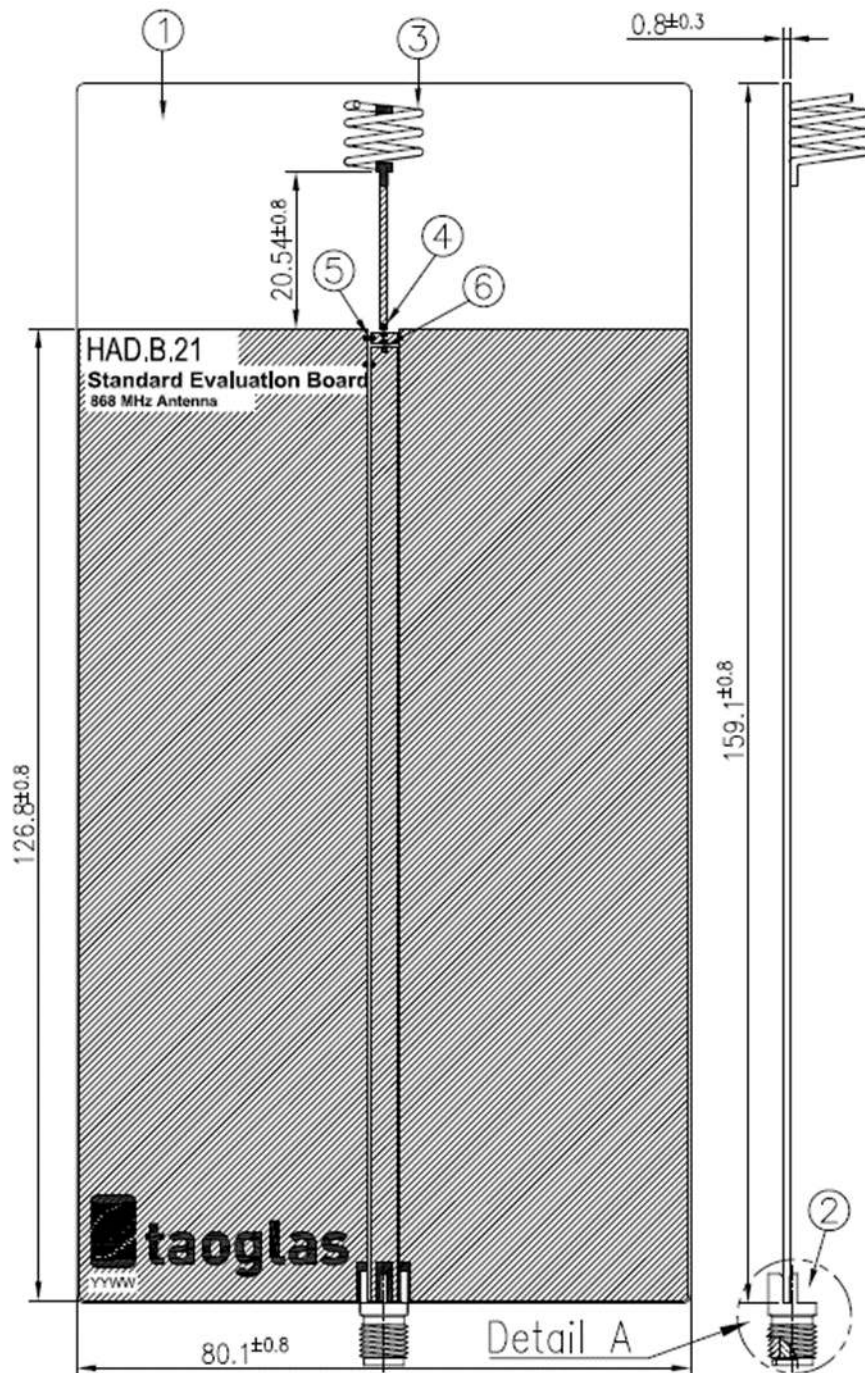

6. Packaging

180 pcs HA.21.A per tray
 Tray Dimensions - 460x340mm
 Weight - 223g

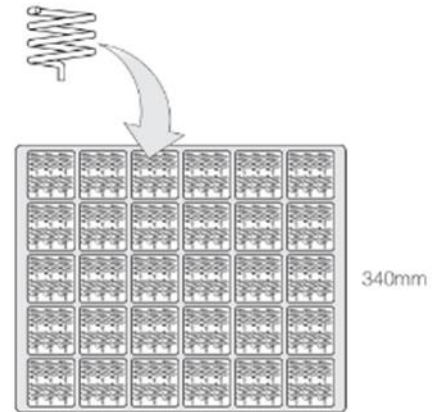

30 trays / 5400 pcs HA.21.A per carton
 Carton dimensions - 530x365x280mm
 Weight - 8Kg

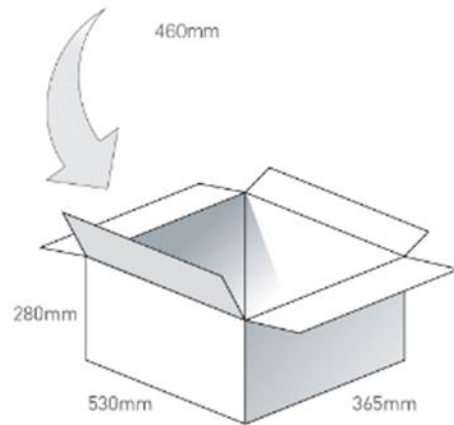

Pallet Dimensions 1100*1100*1550mm
 30 Cartons per Pallet
 6 Cartons per layer
 5 Layers

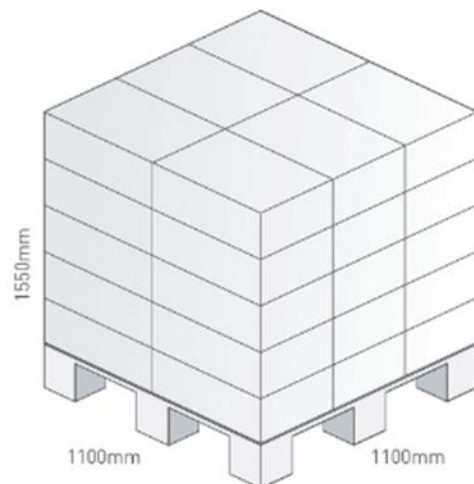

7. Application Note

The HA.21.A has been measured on various length of ground plane, the two different board styles have been laid out in the below note.

7.1 Matching Circuit for Different Ground Lengths – HAD.A.21

HAD.A.21	Ceramic 4	Ceramic 5	Ceramic 6
160mm	0 ohm	2.2pF	0 ohm
150mm	0 ohm	2.2pF	0 ohm
140mm	0 ohm	2.2pF	0 ohm
130mm	0 ohm	2.2pF	0 ohm
120mm	0 ohm	2.2pF	0 ohm
110mm	0 ohm	2.4pF	0 ohm
100mm	0 ohm	2.4pF	0 ohm
90mm	0 ohm	2.4pF	0 ohm
80mm	0 ohm	2.4pF	0 ohm
70mm	0 ohm	2.4pF	1nH
60mm	0 ohm	2.4pF	1nH
50mm	0 ohm	2.4pF	1nH

7.2 Matching Circuit for Different Ground Lengths – HAD.B.21

HAD.B.21	Ceramic 4	Ceramic 5	Ceramic 6
160mm	0 ohm	2.2pF	5.6nH
150mm	0 ohm	2.2pF	9.1nH
140mm	0 ohm	2.2pF	9.1nH
130mm	0 ohm	3.3pF	10nH
120mm	0 ohm	3.6pF	10nH
110mm	0 ohm	open	2.2pF
100mm	0 ohm	open	2.2pF
90mm	0 ohm	open	2.2pF

7.3 Return Loss – HAD.A.21

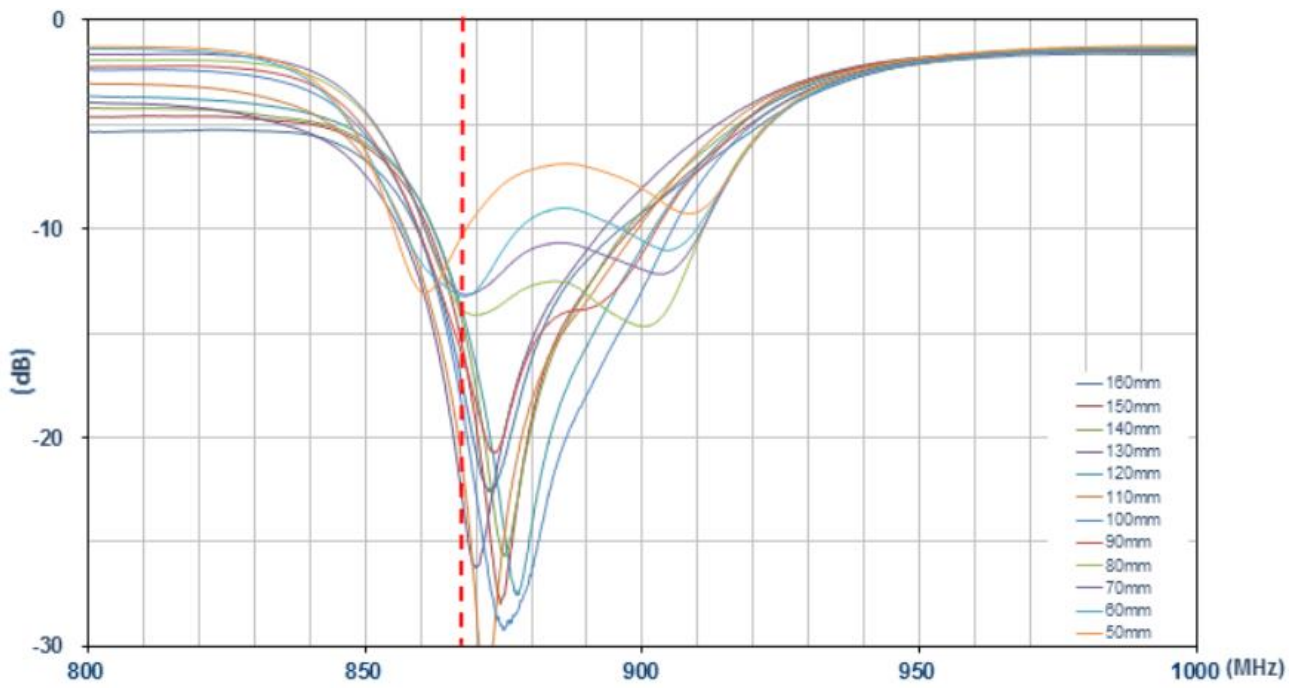

7.4 Return Loss – HAD.B.21

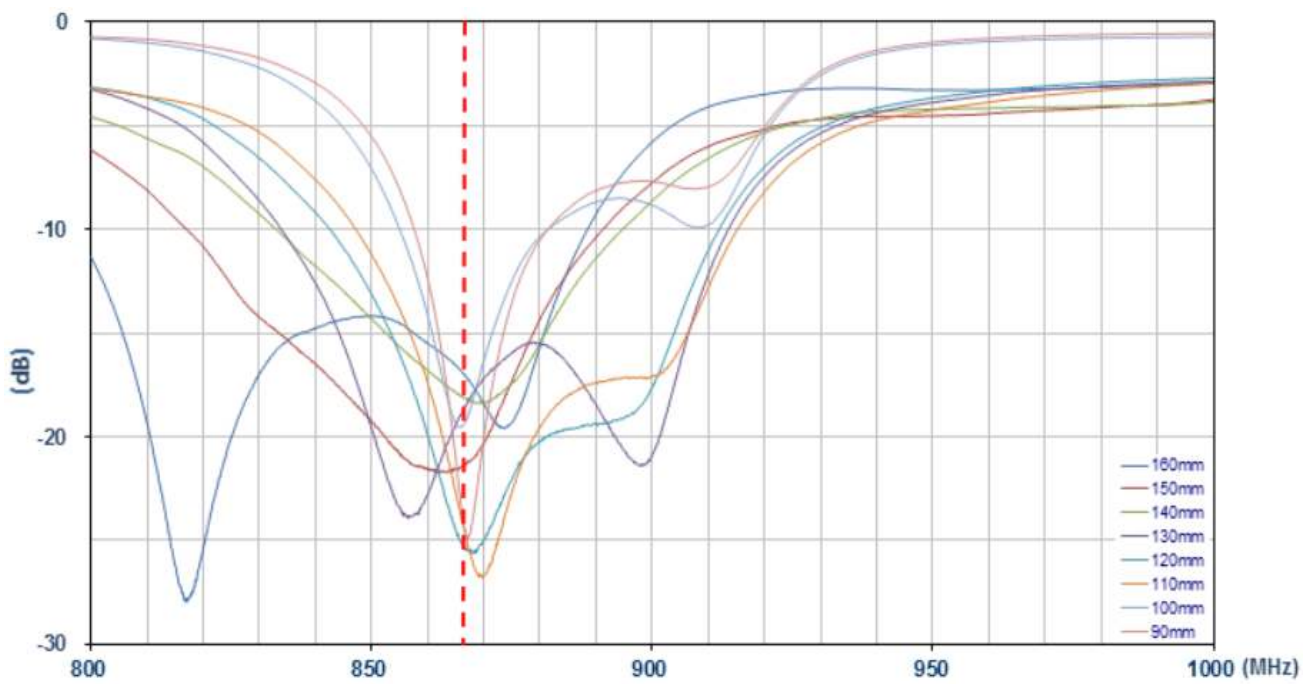

7.5 Efficiency – HAD.A.21

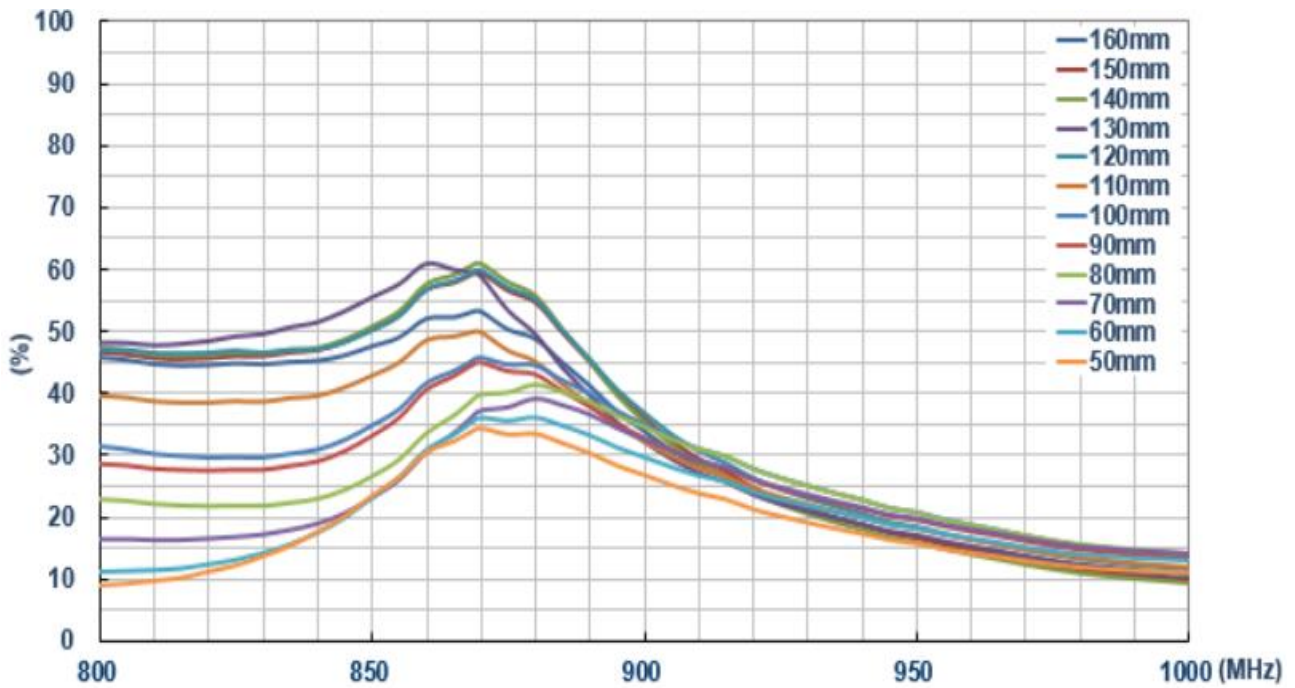

7.6 Efficiency – HAD.B.21

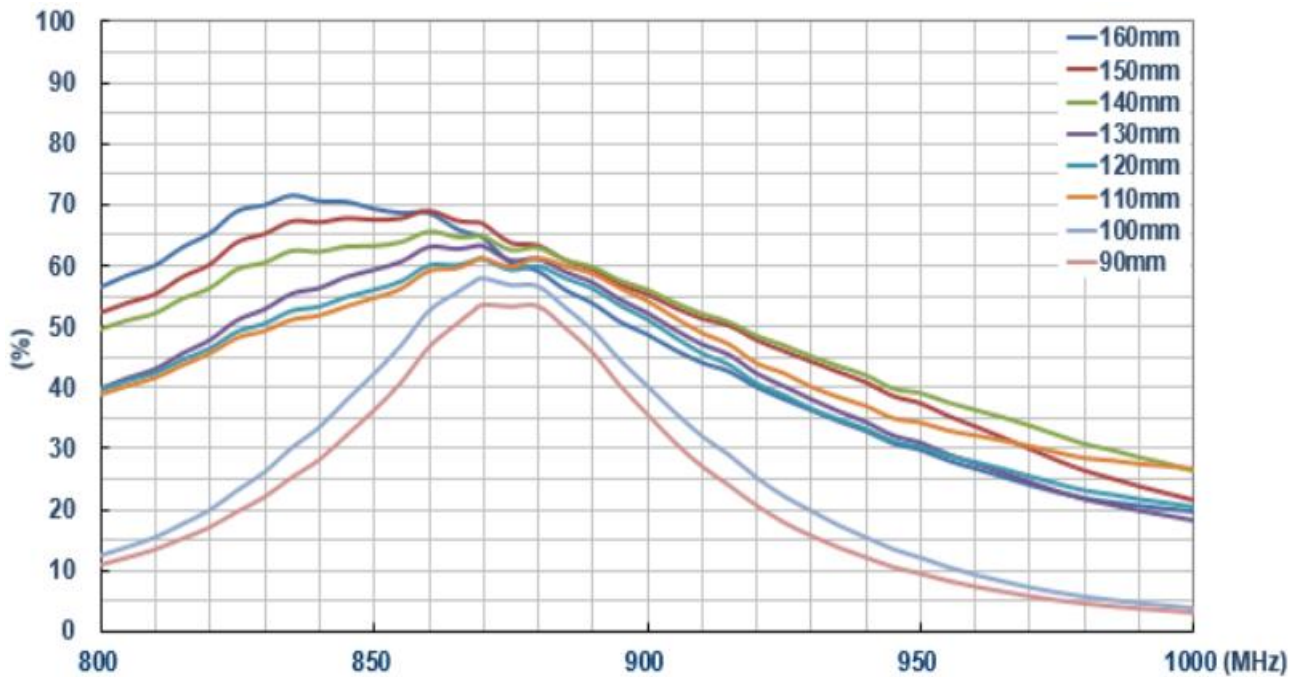

7.7 Average Gain – HAD.A.21

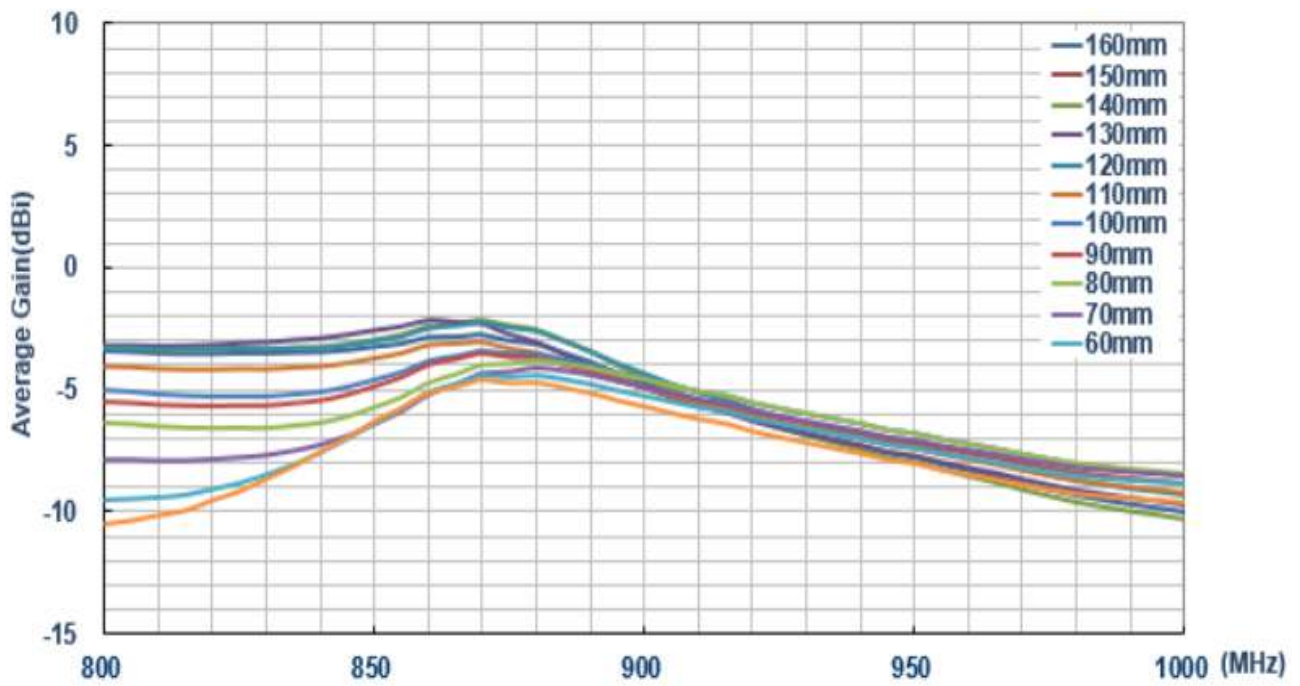

7.8 Average Gain – HAD.B.21

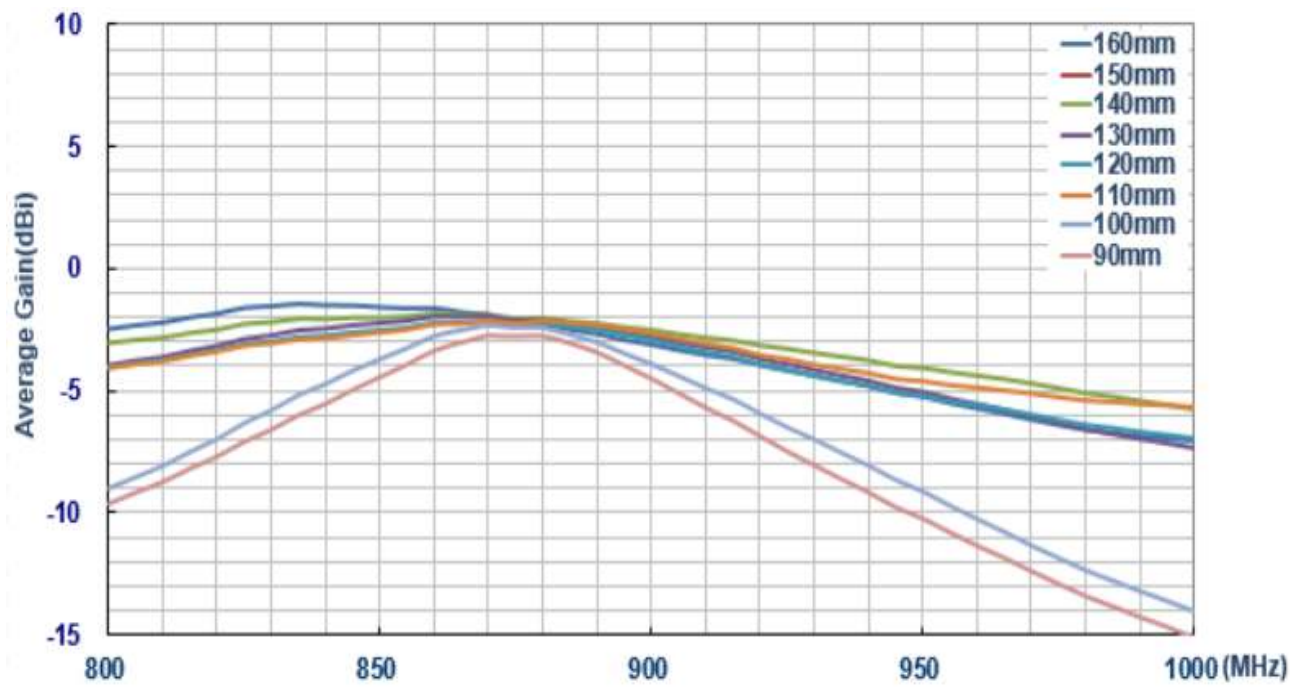

7.9 Peak Gain – HAD.A.21

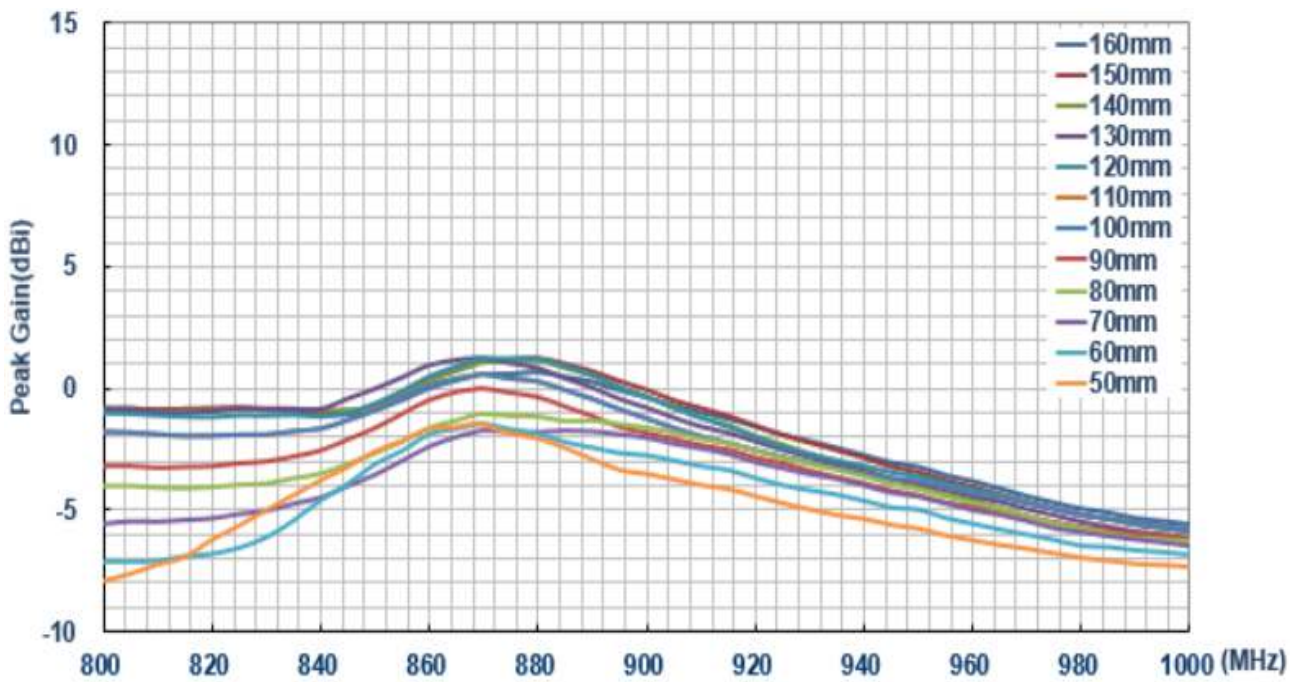

7.10 Peak Gain – HAD.B.21

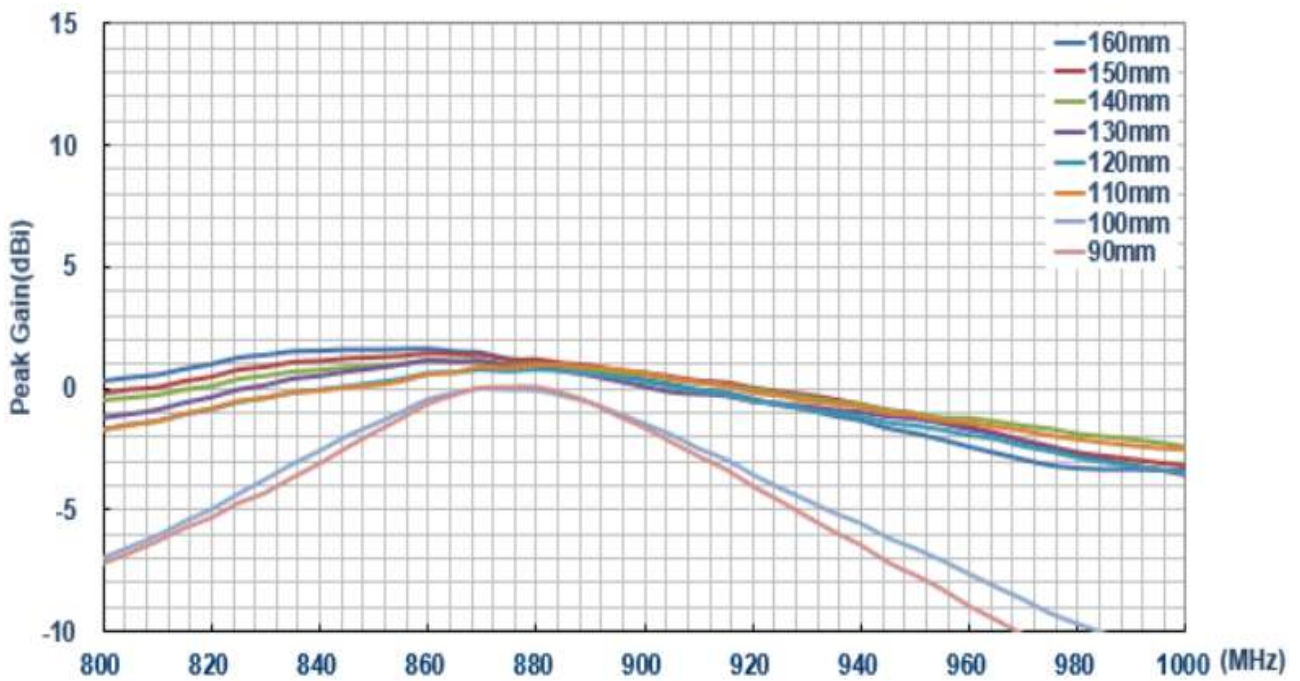

Electrical Performance Table

Mounting Direction	HAD.A.21			HAD.B.21		
Frequency (MHz)	850	868	880	850	868	880
Efficiency (%)						
Ground plane length 160mm	47.48	52.89	48.66	69.27	65.15	59.04
Ground plane length 150mm	50.33	59.00	54.64	67.34	66.93	63.18
Ground plane length 140mm	50.73	60.42	55.73	63.08	64.60	62.80
Ground plane length 130mm	55.38	59.44	49.44	59.41	63.21	61.23
Ground plane length 120mm	50.02	59.18	54.98	55.94	60.70	59.82
Ground plane length 110mm	42.92	49.87	45.21	54.65	60.55	61.17
Ground plane length 100mm	34.92	45.20	44.64	42.34	57.28	56.70
Ground plane length 90mm	32.98	44.25	42.92	36.15	52.23	53.23
Ground plane length 80mm	26.56	38.42	41.24	X	X	X
Ground plane length 70mm	23.03	35.84	39.12	X	X	X
Ground plane length 60mm	23.07	35.06	36.05	X	X	X
Ground plane length 50mm	23.46	33.66	33.44	X	X	X
Average Gain (dBi)						
Ground plane length 160mm	-3.23	-2.77	-3.12	-1.59	-1.86	-2.28
Ground plane length 150mm	-2.98	-2.29	-2.62	-1.71	-1.74	-1.99
Ground plane length 140mm	-2.94	-2.19	-2.53	-2.00	-1.90	-2.01
Ground plane length 130mm	-2.56	-2.26	-3.05	-2.26	-1.99	-2.13
Ground plane length 120mm	-3.00	-2.28	-2.59	-2.52	-2.17	-2.23
Ground plane length 110mm	-3.67	-3.02	-3.44	-2.62	-2.18	-2.13
Ground plane length 100mm	-4.56	-3.45	-3.50	-3.73	-2.42	-2.46
Ground plane length 90mm	-4.81	-3.54	-3.67	-4.41	-2.81	-2.73
Ground plane length 80mm	-5.75	-4.15	-3.84	X	X	X
Ground plane length 70mm	-6.37	-4.46	-4.07	X	X	X
Ground plane length 60mm	-6.36	-4.55	-4.43	X	X	X
Ground plane length 50mm	-6.29	-4.73	-4.75	X	X	X
Peak Gain (dBi)						
Ground plane length 160mm	-0.87	0.51	0.69	1.54	1.45	1.08
Ground plane length 150mm	-0.67	1.01	1.22	1.28	1.39	1.19
Ground plane length 140mm	-0.83	0.88	1.08	0.88	1.10	0.99
Ground plane length 130mm	-0.03	1.22	0.82	0.83	1.14	0.93
Ground plane length 120mm	-0.64	1.09	1.17	0.19	0.69	0.73
Ground plane length 110mm	-0.89	0.55	0.31	0.10	0.79	0.92
Ground plane length 100mm	-1.48	0.07	-0.04	-1.48	-0.06	-0.06
Ground plane length 90mm	-1.64	-0.08	-0.38	-1.85	-0.09	0.03
Ground plane length 80mm	-2.65	-1.10	-1.13	X	X	X
Ground plane length 70mm	-3.56	-1.82	-1.80	X	X	X
Ground plane length 60mm	-3.13	-1.55	-1.89	X	X	X
Ground plane length 50mm	-2.57	-1.46	-2.04	X	X	X

Changelog for the datasheet

SPE-16-8-016 – HA.21.A

Revision: C (Current Version)

Date:	2019-10-10
Changes:	ECR-18-8-259
Changes Made by:	Jack Conroy

Previous Revisions

Revision: B

Date:	2016-03-14
Changes:	Packaging Details Updated
Changes Made by:	Andy Mahoney

Revision: A (Original First Release)

Date:	2016-03-04
Notes:	
Author:	Jack Conroy



TAOGLAS®

www.taoglas.com

