

SCALA NON IMPEGNATIVA
(DO NOT SCALE)
DIMENSIONI IN mm
(DIMENSIONS IN mm)

METRIC

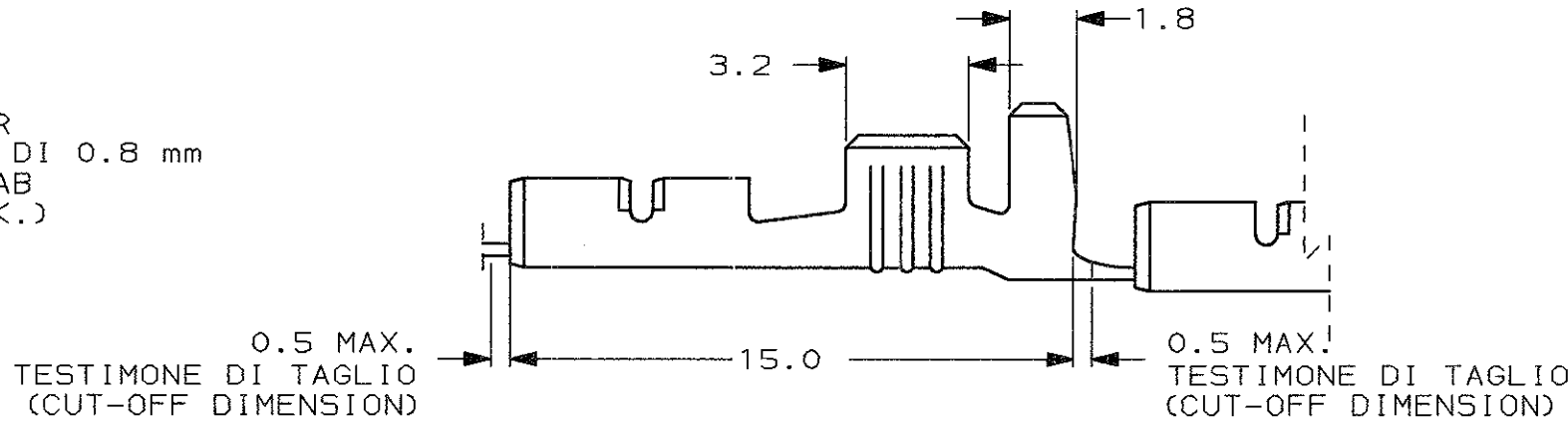

SEZIONE B-B
(SECTION B-B)

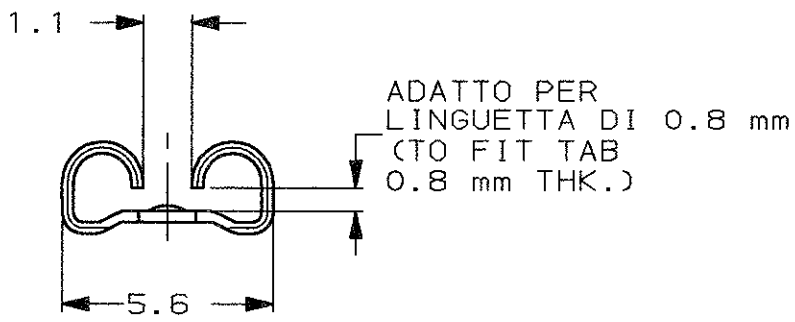
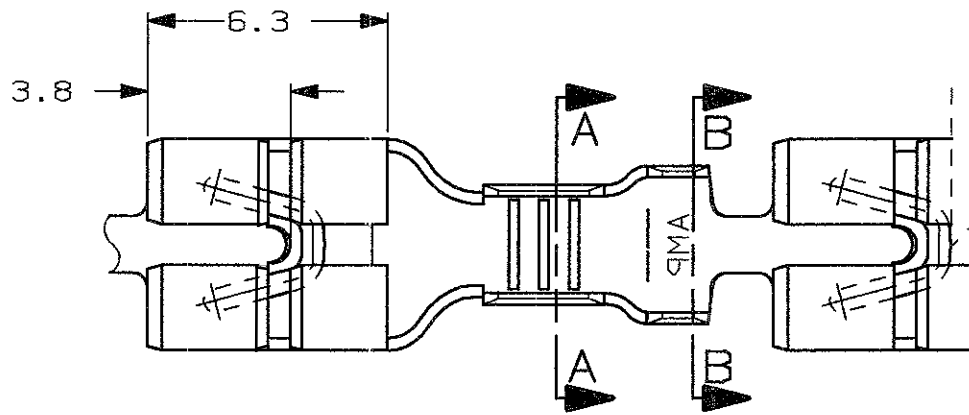
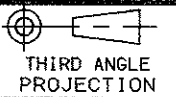
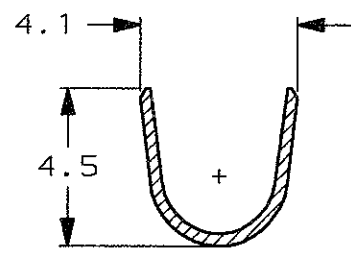

SEZIONE A-A
(SECTION A-A)

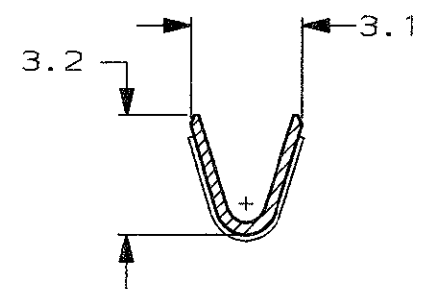

- 4 OBSOLETE PARTS: OBSOLETE CIS STREAMLINING PER D.RENAUD/D.SINISI
- 5 REELED WITH INTERLEAVE PAPER.

4 OBSOLETE

STAGNATO (TIN PLATED)	BRONZO FOSF. (PHOS. BRONZE)	0-100494-4	E
STAGNATO (TIN PLATED)	OTTONE (BRASS)	0-100494-2	E
FINITURA / COLORE (FINISH / COLOUR)	MATERIALE (MATERIAL)	NUMERO (PART NUMBER)	REV

CUSTOMER DWG. FOR REFERENCE ONLY **DISEGNO PER CLIENTE SOLO PER RIFERIMENTO**

THIS DRAWING IS UNPUBLISHED RELEASE FOR PUBLICATION 19

TOLLERANZE, SE NON DIVERSAMENTE SPECIFICATO (TOLERANCES, UNLESS OTHERWISE SPECIFIED)	DIAM. ISOLANTE (INS. DIA. RANGE) mm	RANGO FILO (WIRE RANGE) mm2	SCALA (SCALE)
± 0.3	2.3-3.3 DIA.	0.5-1.5	5:1

ANGOLI (ANGLES) ± 2°

STE TE Connectivity

DIS. H. YAALI (DR.) 30 MAR 2000 DESCRIZIONE (DESCRIPTION) FASTON® Connector, .187" sr. L.I.F. REC. CONTACT.

REV. (REV. LTR.)	REVISIONI (REVISION RECORD)	DIS. DATA (DR) (DATE)	APP. (APP.)	LOC. (LOC.)	SIZE (SIZE)	NUMERO (DWG NO)	REV.	FOGLIO (SHEET)
E5	REVISED PER ECR-20-000060	MK	27 JAN 2020	E5	A3	C-100494	E5	1 OF 1

1) STATO DI FORNITURA SCALA 1:1 (SUPPLY CONDITION SCALE 1:1)

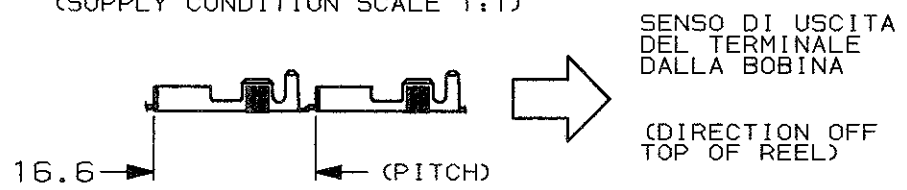

- 2) SPECIFICA DI PRODOTTO 108-19077 (PRODUCT SPEC. 108-19077)
- 3) SPECIFICA DI AGGRAFFATURA 114-20081 (APPLICATION SPEC. 114-20081)

DISTRIBUZIONE (PRINT/DIST.)