

SDURF1540CT/CTR ULTRAFAST RECTIFIER

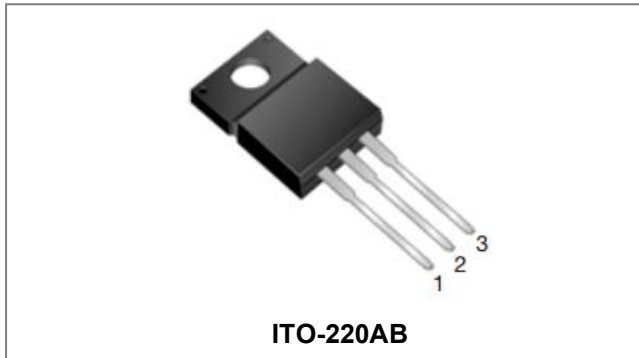

Applications

- Antiparallel diode for high frequency switching devices
- Anti saturation diode
- Snubber diode
- Free wheeling diode in converters and motor control circuits
- Rectifiers in switch mode power supplies (SMPS)
- Inductive heating and melting
- Uninterruptible power supplies (UPS)
- Ultrasonic cleaners and welders

Circuit Diagram

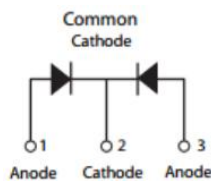

SDURF1540CT

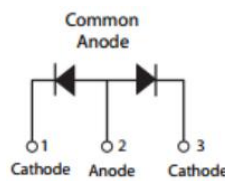

SDURF1540CTR

Features

- Ultra-Fast switching
- High current capability
- Low reverse leakage current
- High surge current capability
- This is a Pb - free device
- All SMC parts are traceable to the wafer lot
- Additional testing can be offered upon request

Maximum Ratings:

| Characteristics | Symbol | Condition | Max. | Units |
|--|-------------|--|------------------------------|-------|
| Peak Repetitive Reverse Voltage | V_{RRM} | - | 400 | V |
| Working Peak Reverse Voltage | V_{RWM} | | | |
| DC Blocking Voltage | V_R | | | |
| Average Rectified Forward Current | $I_{F(AV)}$ | 50% duty cycle @ $T_c=105^\circ\text{C}$, rectangular wave form | 8(Per Leg) 15(Per Device) | A |
| Peak One Cycle Non-Repetitive Surge Current(Per Leg) | I_{FSM} | 8.3ms, Half Sine pulse | 80 | A |

Electrical Characteristics:

| Characteristics | Symbol | Condition | Typ. | Max. | Units |
|--------------------------------|----------|---|------|------|---------------|
| Forward Voltage Drop(Per Leg)* | V_{F1} | @8A, Pulse, $T_J = 25^\circ\text{C}$ | 1.01 | 1.3 | V |
| | V_{F2} | @8A, Pulse, $T_J = 150^\circ\text{C}$ | - | 1.2 | V |
| Reverse Current(Per Leg)* | I_{R1} | @ $V_R = \text{rated } V_R, T_J = 25^\circ\text{C}$ | 0.1 | 10 | μA |
| | I_{R2} | @ $V_R = \text{rated } V_R, T_J = 125^\circ\text{C}$ | 6 | 500 | μA |
| Reverse Recovery Time(Per Leg) | t_{rr} | $I_F=500\text{mA}, I_R=1\text{A}, \text{and } I_m=250\text{mA}$ | 30 | 45 | ns |

* Pulse width < 300 μs , duty cycle < 2%

Thermal-Mechanical Specifications:

| Characteristics | Symbol | Condition | Specification | Units |
|---|-----------------|--------------|---------------|-------|
| Junction Temperature | T_J | - | -55 to +150 | °C |
| Storage Temperature | T_{stg} | - | -55 to +150 | °C |
| Typical Thermal Resistance Junction to Case | $R_{\theta JC}$ | DC operation | 5 | °C/W |
| Approximate Weight | wt | - | 2 | g |
| Case Style | ITO-220AB | | | |

Ratings and Characteristics Curves

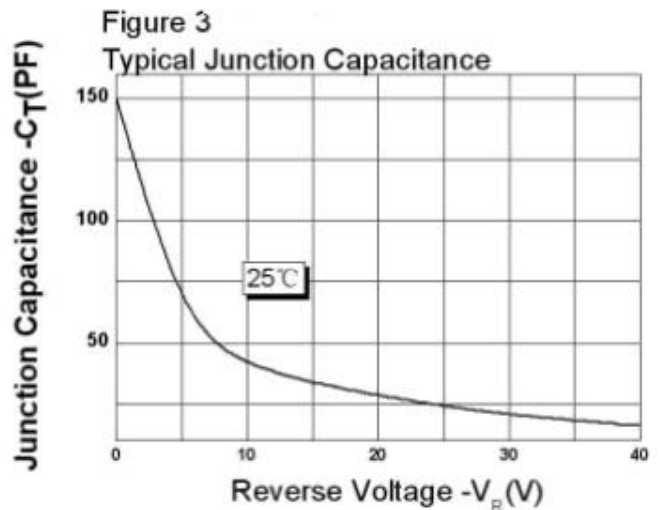
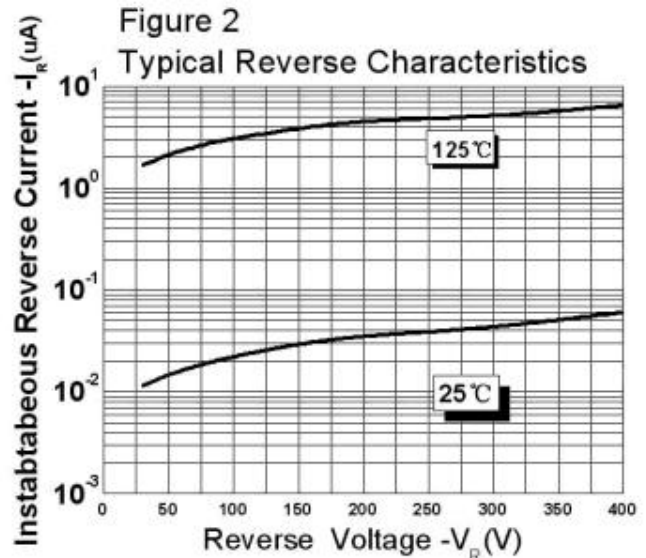
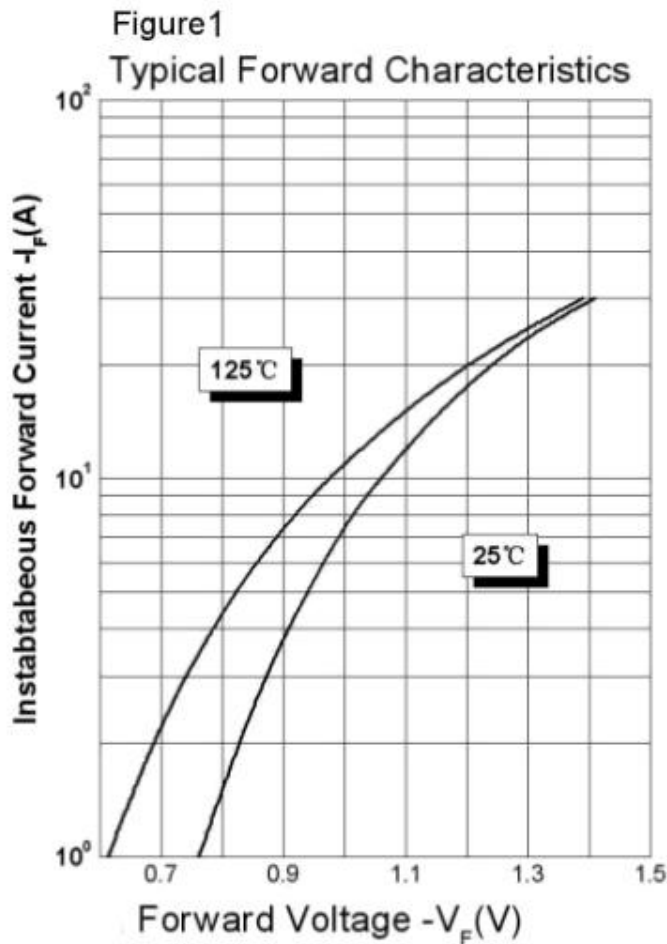

Mechanical Dimensions ITO-220AB

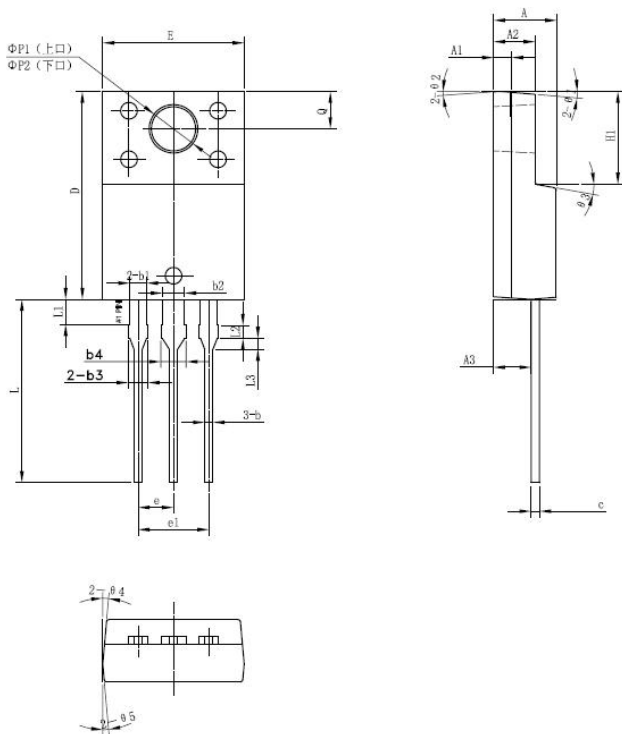

| SYMBOL | Millimeters | | |
|---------|-------------|-------|-------|
| | MIN. | TYP. | MAX. |
| A | 4.30 | 4.50 | 4.70 |
| A1 | 1.10 | 1.30 | 1.50 |
| A2 | 2.80 | 3.00 | 3.20 |
| A3 | 2.50 | 2.70 | 2.90 |
| b | 0.50 | 0.60 | 0.75 |
| b1 | 1.10 | 1.20 | 1.35 |
| b2 | 1.50 | 1.60 | 1.75 |
| b3 | 1.20 | 1.30 | 1.45 |
| b4 | 1.60 | 1.70 | 1.85 |
| c | 0.50 | 0.60 | 0.75 |
| D | 14.80 | 15.00 | 15.20 |
| E | 9.96 | 10.16 | 10.36 |
| e | | 2.55 | |
| e1 | | 5.10 | |
| H1 | 6.50 | 6.70 | 6.90 |
| L | 12.70 | 13.20 | 13.70 |
| L1 | 1.60 | 1.80 | 2.00 |
| L2 | 0.80 | 1.00 | 1.20 |
| L3 | 0.60 | 0.80 | 1.00 |
| ΦP1(上□) | 3.30 | 3.50 | 3.70 |
| ΦP2(下□) | 2.99 | 3.19 | 3.39 |
| Q | 2.50 | 2.70 | 2.90 |
| Θ1 | | 5° | |
| Θ2 | | 4° | |
| Θ3 | | 10° | |
| Θ4 | | 5° | |
| Θ5 | | 5° | |

Tube Specification

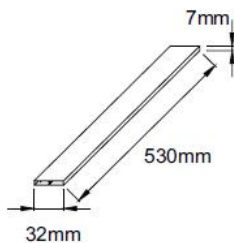

Ordering Information

| Device | Package | Shipping |
|------------------|------------------------|--------------|
| SDURF1540CT(CTR) | ITO-220AB (Pb-Free) | 50 pcs/ tube |

For information on tape and reel specifications, including part orientation and tape sizes, please refer to our tape and reel packaging specification.

Marking Diagram

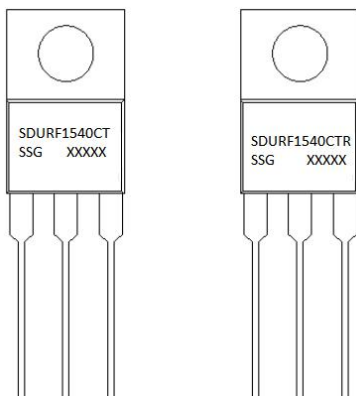

Where XXXXX is YYWWL

SDUR = Device Type
 F = Package type
 15 = Forward Current (15A)
 40 = Reverse Voltage (400V)
 CT(CTR) = Configuration
 SSG = SSG
 YY = Year
 WW = Week
 L = Lot Number

Cautions: Molding resin
 Epoxy resin UL:94V-0



DISCLAIMER:

1- The information given herein, including the specifications and dimensions, is subject to change without prior notice to improve product characteristics. Before ordering, purchasers are advised to contact the SMC - Sangdest Microelectronics (Nanjing) Co., Ltd sales department for the latest version of the datasheet(s).

2- In cases where extremely high reliability is required (such as use in nuclear power control, aerospace and aviation, traffic equipment, medical equipment, and safety equipment), safety should be ensured by using semiconductor devices that feature assured safety or by means of users' fail-safe precautions or other arrangement.

3- In no event shall SMC - Sangdest Microelectronics (Nanjing) Co., Ltd be liable for any damages that may result from an accident or any other cause during operation of the user's units according to the datasheet(s). SMC - Sangdest Microelectronics (Nanjing) Co., Ltd assumes no responsibility for any intellectual property claims or any other problems that may result from applications of information, products or circuits described in the datasheets.

4- In no event shall SMC - Sangdest Microelectronics (Nanjing) Co., Ltd be liable for any failure in a semiconductor device or any secondary damage resulting from use at a value exceeding the absolute maximum rating.

5- No license is granted by the datasheet(s) under any patents or other rights of any third party or SMC - Sangdest Microelectronics (Nanjing) Co., Ltd.

6- The datasheet(s) may not be reproduced or duplicated, in any form, in whole or part, without the expressed written permission of SMC - Sangdest Microelectronics (Nanjing) Co., Ltd.

7- The products (technologies) described in the datasheet(s) are not to be provided to any party whose purpose in their application will hinder maintenance of international peace and safety nor are they to be applied to that purpose by their direct purchasers or any third party. When exporting these products (technologies), the necessary procedures are to be taken in accordance with related laws and regulations..