



Is Now Part of



**ON Semiconductor®**

To learn more about ON Semiconductor, please visit our website at  
[www.onsemi.com](http://www.onsemi.com)

Please note: As part of the Fairchild Semiconductor integration, some of the Fairchild orderable part numbers will need to change in order to meet ON Semiconductor's system requirements. Since the ON Semiconductor product management systems do not have the ability to manage part nomenclature that utilizes an underscore (\_), the underscore (\_) in the Fairchild part numbers will be changed to a dash (-). This document may contain device numbers with an underscore (\_). Please check the ON Semiconductor website to verify the updated device numbers. The most current and up-to-date ordering information can be found at [www.onsemi.com](http://www.onsemi.com). Please email any questions regarding the system integration to [Fairchild\\_questions@onsemi.com](mailto:Fairchild_questions@onsemi.com).

ON Semiconductor and the ON Semiconductor logo are trademarks of Semiconductor Components Industries, LLC dba ON Semiconductor or its subsidiaries in the United States and/or other countries. ON Semiconductor owns the rights to a number of patents, trademarks, copyrights, trade secrets, and other intellectual property. A listing of ON Semiconductor's product/patent coverage may be accessed at [www.onsemi.com/site/pdf/Patent-Marking.pdf](http://www.onsemi.com/site/pdf/Patent-Marking.pdf). ON Semiconductor reserves the right to make changes without further notice to any products herein. ON Semiconductor makes no warranty, representation or guarantee regarding the suitability of its products for any particular purpose, nor does ON Semiconductor assume any liability arising out of the application or use of any product or circuit, and specifically disclaims any and all liability, including without limitation special, consequential or incidental damages. Buyer is responsible for its products and applications using ON Semiconductor products, including compliance with all laws, regulations and safety requirements or standards, regardless of any support or applications information provided by ON Semiconductor. "Typical" parameters which may be provided in ON Semiconductor data sheets and/or specifications can and do vary in different applications and actual performance may vary over time. All operating parameters, including "Typicals" must be validated for each customer application by customer's technical experts. ON Semiconductor does not convey any license under its patent rights nor the rights of others. ON Semiconductor products are not designed, intended, or authorized for use as a critical component in life support systems or any FDA Class 3 medical devices or medical devices with a same or similar classification in a foreign jurisdiction or any devices intended for implantation in the human body. Should Buyer purchase or use ON Semiconductor products for any such unintended or unauthorized application, Buyer shall indemnify and hold ON Semiconductor and its officers, employees, subsidiaries, affiliates, and distributors harmless against all claims, costs, damages, and expenses, and reasonable attorney fees arising out of, directly or indirectly, any claim of personal injury or death associated with such unintended or unauthorized use, even if such claim alleges that ON Semiconductor was negligent regarding the design or manufacture of the part. ON Semiconductor is an Equal Opportunity/Affirmative Action Employer. This literature is subject to all applicable copyright laws and is not for resale in any manner.



# FAN5362

## 3MHz, 500mA / 750mA Synchronous Buck Regulator

### Features

- 3MHz Fixed-Frequency Operation
- 45µA Typical Quiescent Current
- 1.80 to 3.6V Fixed Output Voltage
- 500mA or 750mA Output Current Capability
- 2.7V to 5.5V Input Voltage Range
- Smooth Transitions to/from 100% Duty Cycle when  $V_{IN}$  Drops
- PFM Mode for High Efficiency in Light Load
- Best-in-Class Load Transient Response
- Best-in-Class Efficiency
- Forced PWM and External Clock Synchronization
- Internal Soft-Start
- Input Under-Voltage Lockout (UVLO)
- Thermal Shutdown and Overload Protection
- 6-Bump WLCSP, 0.4mm Pitch or 6-Lead 2 x 2mm Ultrathin Molded Leadless Package

### Applications

- SD Flash Memory Power Supply
- RF Transceiver Power
- Cell Phones, Smart Phones
- Tablets, Netbooks®, Ultra-Mobile PCs
- 3G, LTE, WiMAX™, WiBro®, and WiFi® Data Cards
- Gaming Devices, Digital Cameras DC/DC Micro Modules

### Description

The FAN5362 is a 500mA or 750mA, step-down, switching voltage regulator that delivers a fixed output voltage from an input voltage supply of 2.7V to 5.5V. Using a proprietary architecture with synchronous rectification, the FAN5362 is capable of delivering a peak efficiency of 96%, while maintaining efficiency over 90% with load currents as low as 1mA.

This regulator transitions seamlessly into and out of 100% duty cycle operation when the supply dips to or below the regulation setpoint and smoothly recovers full regulation without overshoot when the supply recovers.

The regulator operates at a nominal fixed frequency of 3MHz, which reduces the value of the external components to 1µH for the output inductor and 4.7µF for the output capacitor. The PWM modulator can be synchronized to an external frequency source.

At moderate and light loads, pulse frequency modulation is used to operate the device in power-save mode with a typical quiescent current of 45µA. Even with such a low quiescent current, the part exhibits excellent transient response during large load swings. At higher loads, the system automatically switches to fixed-frequency control, operating at 3MHz. In shutdown mode, the supply current drops below 1µA, reducing power consumption. For applications that require minimum ripple or fixed frequency, PFM mode can be disabled using the MODE pin.

The FAN5362 is available in 6-bump, 0.4mm pitch, Wafer-Level Chip-Scale Package (WLCSP) and 6-Lead 2 x 2mm Ultrathin Molded Leadless Package (UMLP).

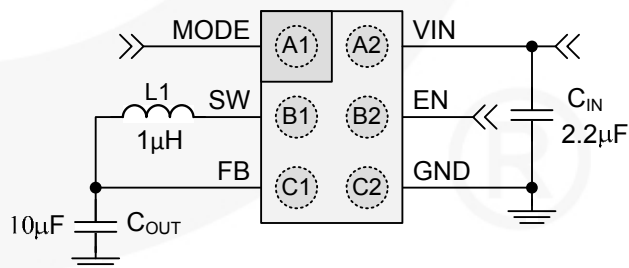

Figure 1. Typical Application

Trademarks are the property of their respective owners.

## Ordering Information

Part Number	Output Voltage <sup>(1)</sup>	Output Current (mA)	Operating Temperature Range	Package	Packing Method
FAN5362UC21X <sup>(2)</sup>	2.1	750	-40 to 85°C	WLCSP-6, 0.4mm Pitch	Tape and Reel
FAN5362UC25X <sup>(2)</sup>	2.5	500			
FAN5362UC27X	2.7	500			
FAN5362UC29X	2.9	500			
FAN5362UC33X	3.3	500		6-Lead, 2 x 2mm UMLP	
FAN5362UMP29X	2.9	500			
FAN5362UMP33X	3.3	500			

### Note:

- Other voltage options available on request. Contact a Fairchild representative.
- Preliminary; not full production release at this time. Contact a Fairchild representative for information.

**Table 1. Recommended Components for Circuit in Figure 1**

Component	Description	Example Part	Typical
L1	1μH, 2012, 190mΩ, 800mA	Murata LQM21PN1R0MC0	1μH
C <sub>IN</sub>	2.2μF, 6.3V, X5R, 0402	Murata GRM155R60J225ME15	2.2μF
	2.2μF, 6.3V, X5R, 0603	GRM188R60J225KE19D	
C <sub>OUT</sub>	4.7μF, X5R, 0603	Murata GRM188R60J475M	4.7μF
	10μF, X5R, 0603	Murata GRM188R60J106ME47D	10.0μF

## Pin Configuration

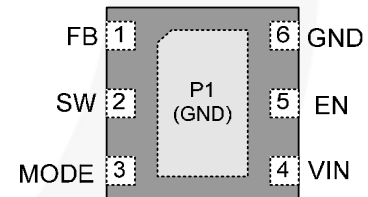
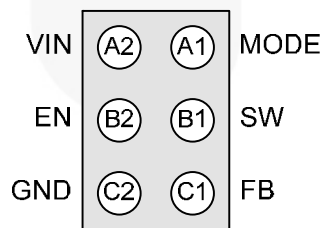
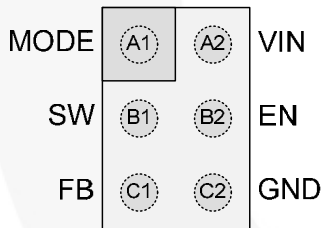

**Figure 2. WLCSP, Bumps Facing Down**   **Figure 3. WLCSP, Bumps Facing Up**   **Figure 4. UMLP, Leads Facing Down**

## Pin Definitions

WLCSP Bump #	UMLP Pin #	Name	Description
A1	3	MODE	Logic 1 on this pin forces the IC to stay in PWM mode. Logic 0 allows the IC to automatically switch to PFM during light loads. The regulator also synchronizes its switching frequency to two times the frequency provided on this pin. Do not leave this pin floating. When tying HIGH, use at least 1kΩ series resistor if V <sub>IN</sub> is expected to exceed 4.5V.
B1	2	SW	<b>Switching Node.</b> Connect to output inductor.
C1	1	FB	<b>Feedback / V<sub>OUT</sub>.</b> Connect to output voltage.
C2	6	GND	<b>Ground.</b> Power and IC ground. All signals are referenced to this pin.
B2	5	EN	<b>Enable.</b> The device is in shutdown mode when voltage to this pin is <0.4V and enabled when >1.2V. Do not leave this pin floating. When tying HIGH, use at least 1kΩ series resistor if V <sub>IN</sub> is expected to exceed 4.5V.
A2	4	VIN	<b>Input Voltage.</b> Connect to input power source.

## Absolute Maximum Ratings

Stresses exceeding the absolute maximum ratings may damage the device. The device may not function or be operable above the recommended operating conditions and stressing the parts to these levels is not recommended. In addition, extended exposure to stresses above the recommended operating conditions may affect device reliability. The absolute maximum ratings are stress ratings only.

Symbol	Parameter		Min.	Max.	Unit
$V_{IN}$	Input Voltage		-0.3	6.5	V
$V_{SW}$	Voltage on SW Pin		-0.3	$V_{IN} + 0.3^{(3)}$	V
$V_{CTRL}$	EN and MODE Pin Voltage		-0.3	$V_{IN} + 0.3^{(3)}$	V
$V_{FB}$	FB Pin		-0.3	4	V
ESD	Electrostatic Discharge Protection Level	Human Body Model per JESD22-A114	3.0		kV
		Charged Device Model per JESD22-C101	1.5		
$T_J$	Junction Temperature		-40	+150	°C
$T_{STG}$	Storage Temperature		-65	+150	°C
$T_L$	Lead Soldering Temperature, 10 Seconds			+260	°C

### Note:

3. Lesser of 6.5V or  $V_{IN}+0.3V$ .

## Recommended Operating Conditions

The Recommended Operating Conditions table defines the conditions for actual device operation. Recommended operating conditions are specified to ensure optimal performance to the datasheet specifications. Fairchild does not recommend exceeding them or designing to Absolute Maximum Ratings.

Symbol	Parameter	Min.	Typ.	Max.	Unit
$V_{CC}$	Supply Voltage Range	2.7 <sup>(4)</sup>		5.5	V
$I_{OUT}$	Output Current for 2.1V	0		750	mA
	Output Current for 2.5V, 2.7V, 2.9V, 3.3V	0		500	
L	Inductor		1		μH
$C_{IN}$	Input Capacitor		2.2		μF
$C_{OUT}$	Output Capacitor		10	24	μF
$T_A$	Operating Ambient Temperature	-40		+85	°C
$T_J$	Operating Junction Temperature	-40		+125	°C

### Note:

4. Minimum  $V_{IN} = V_{OUT} + 200mV$  or 2.7V, whichever is greater.

## Thermal Properties

Junction-to-ambient thermal resistance is a function of application and board layout. This data is measured with four-layer 1s2p boards in accordance to JEDEC standard JESD51. Special attention must be paid not to exceed junction temperature  $T_{J(max)}$  at a given ambient temperature  $T_A$ .

Symbol	Parameter	Typical	Unit
$\theta_{JA}$	Junction-to-Ambient Thermal Resistance	WLSCP	150
		UMLP	49

## Electrical Characteristics

Minimum and maximum values are at  $V_{IN} = V_{EN} = 2.7V$  to  $5.5V$ ,  $V_{MODE} = 0V$  (AUTO Mode),  $T_A = -40^{\circ}C$  to  $+85^{\circ}C$ ; circuit of Figure 1, unless otherwise noted. Typical values are at  $T_A = 25^{\circ}C$ ,  $V_{IN} = V_{EN} = 3.6V$ ,  $V_{MODE} = 0V$ ,  $C_{OUT} = 10\mu F$ .

Symbol	Parameter	Conditions	Min.	Typ.	Max.	Unit	
<b>Power Supplies</b>							
$I_Q$	Quiescent Current	No Load, Not Switching, $V_{IN} > 3V$		45	75	$\mu A$	
		PWM Mode		5		$mA$	
$I_{(SD)}$	Shutdown Supply Current	EN = GND		0.05	1.00	$\mu A$	
$V_{UVLO}$	Under-Voltage Lockout Threshold	Rising $V_{IN}$		2.5	2.6	V	
$V_{UVHYS}$	Under-Voltage Lockout Hysteresis			175		mV	
$V_{(ENH)}$	Enable HIGH-Level Input Voltage		1.05			V	
$V_{(ENL)}$	Enable LOW-Level Input Voltage				0.4	V	
$I_{(EN)}$	Enable Input Leakage Current	EN to $V_{IN}$ or GND		0.01	1.00	$\mu A$	
$V_{(MH)}$	MODE HIGH-Level Input Voltage		1.05			V	
$V_{(ML)}$	MODE LOW-Level Input Voltage				0.4	V	
$I_{(M)}$	MODE Input Leakage Current	MODE to $V_{IN}$ or GND		0.01	1.00	$\mu A$	
<b>Switching and Synchronization</b>							
$f_{SW}$	Switching Frequency <sup>(5)</sup>	$V_{IN} = 3.6V$ , $T_A = 25^{\circ}C$	2.7	3.0	3.3	MHz	
$f_{SYNC}$	MODE Synchronization Range <sup>(5)</sup>	Square Wave at MODE Input	1.3	1.5	1.7	MHz	
<b>Regulation</b>							
$V_O$	Output Voltage Accuracy	2.10V	$I_{LOAD} = 0$ to 750mA	2.037 (-3%)	2.100	2.163 (+3%)	V
		2.50V	$I_{LOAD} = 0$ to 400mA, $V_{IN} \geq V_{OUT} + 200mV$	2.375 (-5%)	2.500	2.575 (+3%)	
			$I_{LOAD} = 0$ to 500mA, $V_{IN} \geq V_{OUT} + 300mV$	2.425 (-3%)	2.500	2.575 (+3%)	
		2.70V, 2.90V, 3.30V	$I_{LOAD} = 0$ to 400mA, $V_{IN} \geq V_{OUT} + 150mV$	-5%		+3%	
$I_{LOAD} = 0$ to 500mA, $V_{IN} \geq V_{OUT} + 300mV$	-3%			+3%			
$t_{SS}$	Soft-Start	From EN Rising Edge		180	300	$\mu s$	
<b>Output Driver</b>							
$R_{DS(on)}$	PMOS On Resistance	$V_{IN} = V_{GS} = 3.6V$		330		$m\Omega$	
	NMOS On Resistance	$V_{IN} = V_{GS} = 3.6V$		300		$m\Omega$	
$I_{LIM(OL)}$	PMOS Peak Current Limit <sup>(5)</sup>	$V_{OUT} = 2.1V$		1375		$mA$	
		$V_{OUT} = 2.5V, 2.7V, 2.9V, 3.3V$	800	1000	1150	$mA$	
$T_{TSD}$	Thermal Shutdown			150		$^{\circ}C$	
$T_{HYS}$	Thermal Shutdown Hysteresis			15		$^{\circ}C$	

### Notes:

- Limited by the effect of  $t_{OFF}$  minimum (see Figure 8 in Typical Performance Characteristics).
- The Electrical Characteristics table reflects open-loop data. Refer to the Operation Description and Typical Characteristics for closed-loop data.

## Typical Characteristics

Unless otherwise noted,  $V_{IN}=V_{EN}=3.6V$ ,  $V_{MODE}=0$  (AUTO),  $V_{OUT}=2.9V$ ,  $C_{OUT}=10\mu F$ , and  $T_A=25^\circ C$ .

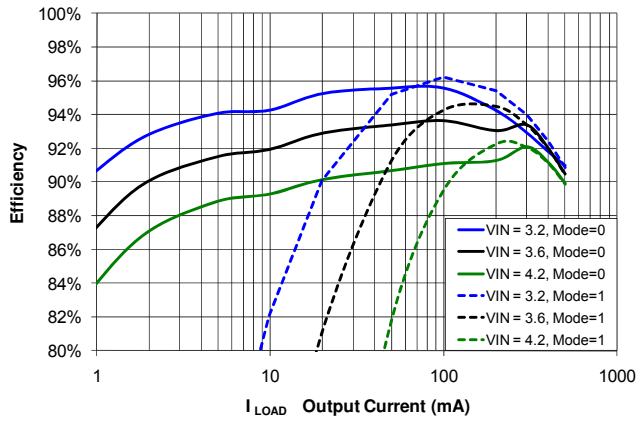

Figure 5. Efficiency vs. Load Current and Input Supply

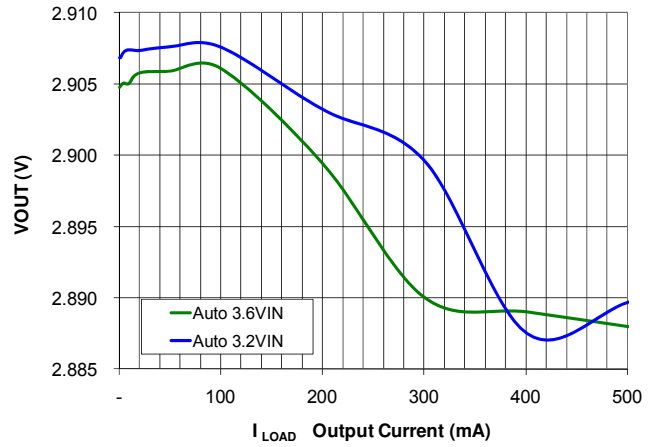

Figure 6. Load Regulation

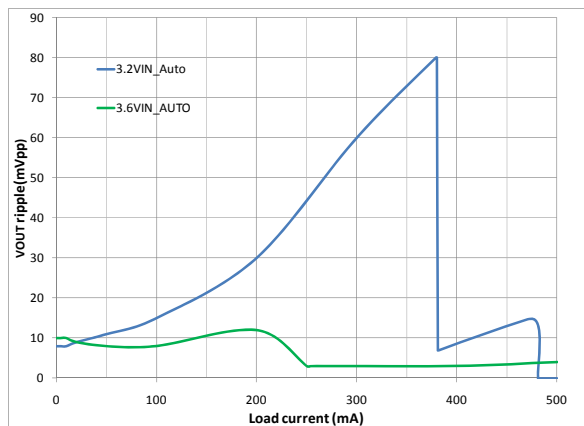

Figure 7. Ripple

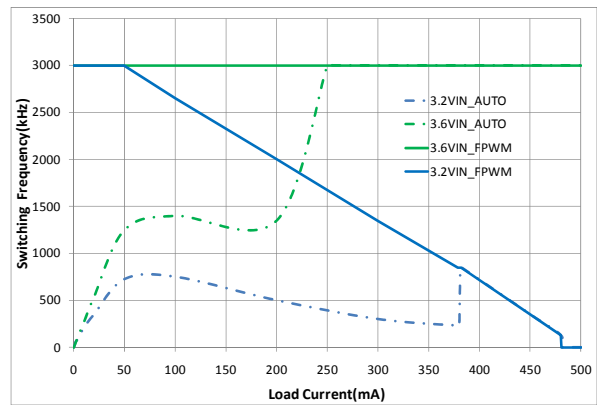

Figure 8. Effect of  $t_{OFF(MIN)}$  on Reducing Switching Frequency

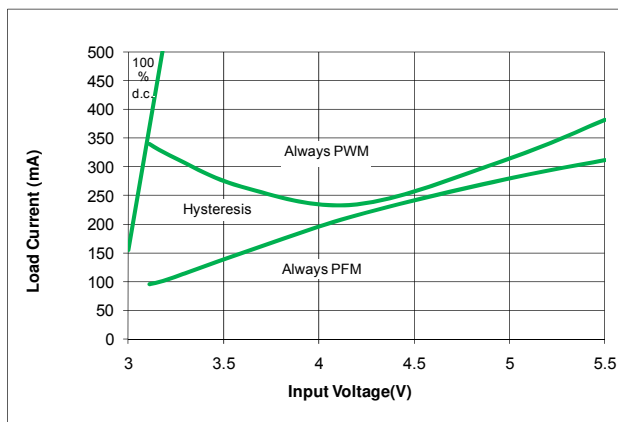

Figure 9. PFM / PWM Boundaries

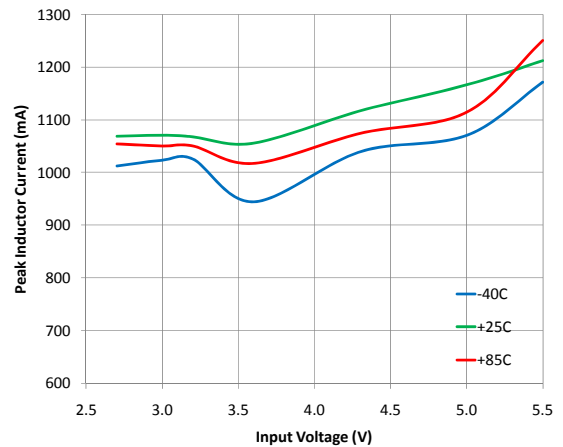

Figure 10. Peak Inductor Current

## Typical Characteristics

Unless otherwise noted,  $V_{IN}=V_{EN}=3.6V$ ,  $V_{MODE}=0$  (AUTO),  $V_{OUT}=2.9V$ ,  $C_{OUT}=10\mu F$ , and  $T_A=25^\circ C$ .

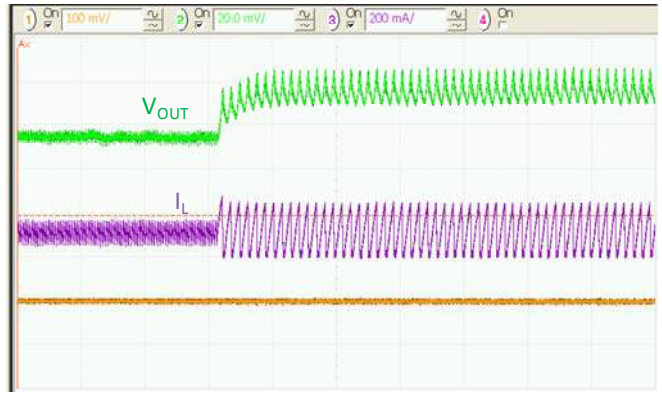
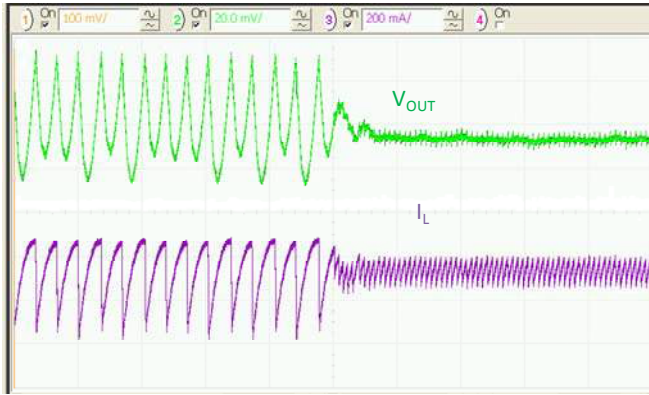

Figure 11. PFM to PWM Transition at  $V_{IN}=3.2V$ ,  $10\mu s/div$ . Figure 12. PWM to PFM Transition at  $V_{IN}=3.2V$ ,  $10\mu s/div$ .

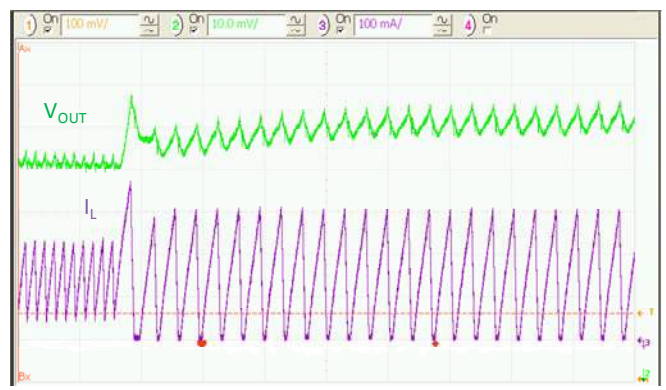
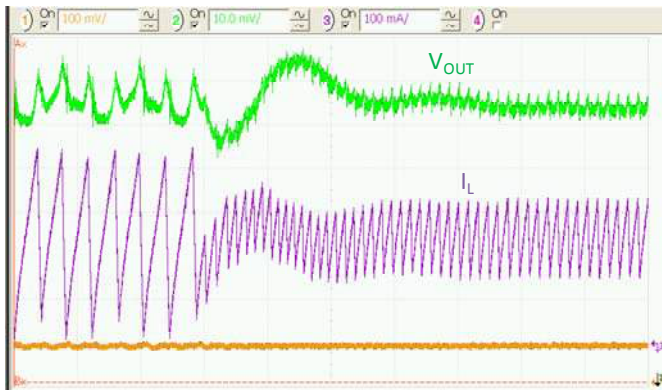

Figure 13. PFM to PWM Transition at  $V_{IN}=3.6V$ ,  $2\mu s/div$ . Figure 14. PWM to PFM Transition at  $V_{IN}=3.6V$ ,  $2\mu s/div$ .

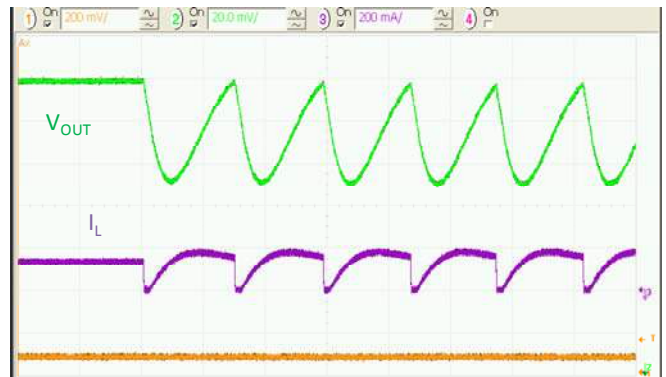

Figure 15. Regular Switching to 100% Duty Cycle Transition at  $V_{IN}=3.2V$ ,  $5\mu s/div$ .

Figure 16. 100% Duty Cycle to Regular Switching Transition at  $V_{IN}=3.2V$ ,  $5\mu s/div$ .

## Typical Characteristics

Unless otherwise noted,  $V_{IN}=V_{EN}=3.6V$ ,  $V_{MODE}=0$  (AUTO),  $V_{OUT}=2.9V$ ,  $C_{OUT}=10\mu F$ , and  $T_A=25^\circ C$ .

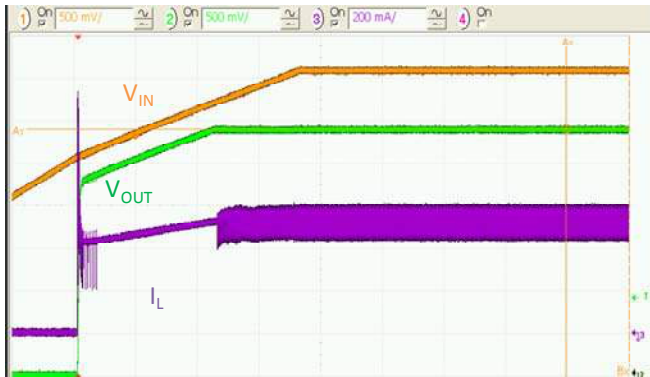

Figure 17. Startup Ramping  $V_{IN}=V_{EN}$  with 500mA Load, 1ms/div.



Figure 18. Startup and Shutdown through  $V_{EN}$  with 500mA Load, 50 $\mu s$ /div.

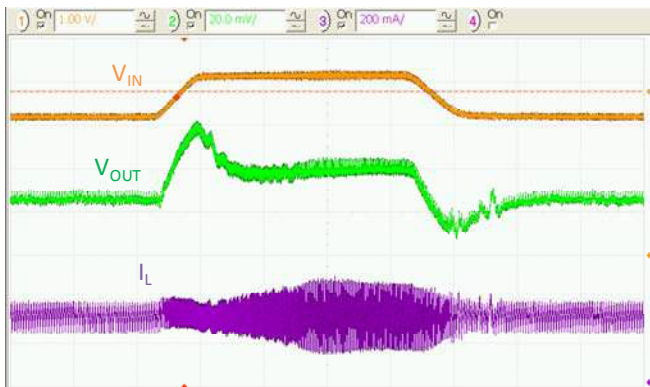

Figure 19. Line Transient at  $V_{IN}=3.2V$  to  $4.2V$ , 300mA Load,  $t_{RISE}=t_{FALL}=10\mu s$ , 20 $\mu s$ /div.

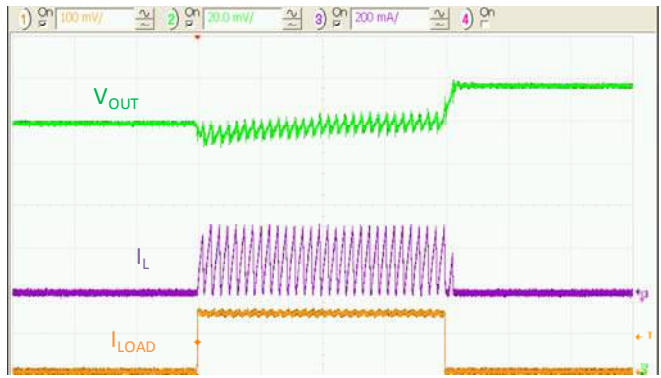

Figure 20. Load Transient 0mA to 150mA,  $V_{IN}=3.6V$ ,  $t_{RISE}=t_{FALL}=100ns$ , 5 $\mu s$ /div.

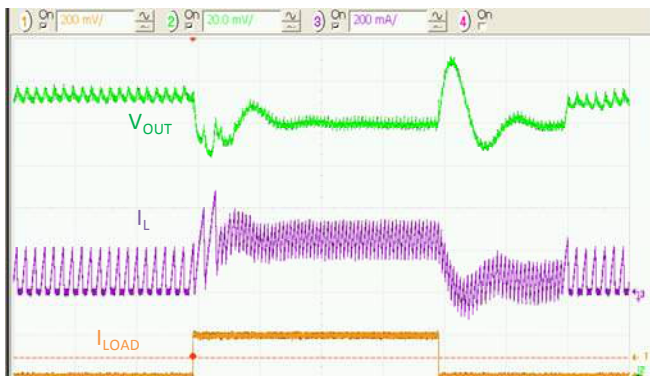

Figure 21. Load Transient 50mA to 250mA,  $V_{IN}=3.6V$ ,  $t_{RISE}=t_{FALL}=100ns$ , 5 $\mu s$ /div.



Figure 22. Load Transient 150mA to 400mA,  $V_{IN}=3.6V$ ,  $t_{RISE}=t_{FALL}=100ns$ , 5 $\mu s$ /div.



## Typical Characteristics

Unless otherwise noted,  $V_{IN}=V_{EN}=3.6V$ ,  $V_{MODE}=0$  (AUTO),  $V_{OUT}=2.9V$ ,  $C_{OUT}=10\mu F$ , and  $T_A=25^\circ C$ .



Figure 23. Load Transient 50mA to 250mA,  $V_{IN}=3V$ ,  $t_{RISE}=t_{FALL}=100ns$ ,  $5\mu s/div$ .



Figure 24. Load Transient 150mA to 400mA,  $V_{IN}=3V$ ,  $t_{RISE}=t_{FALL}=100ns$ ,  $5\mu s/div$ .

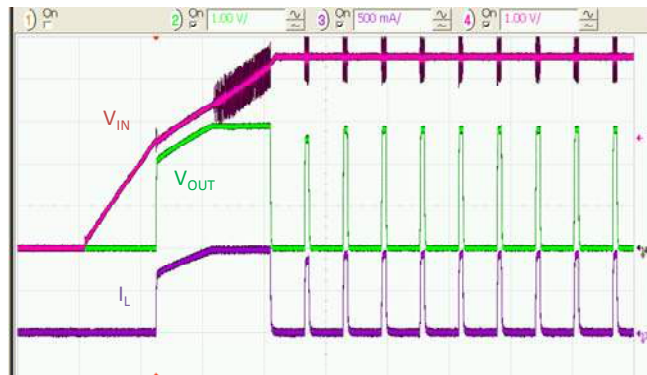

Figure 25. Startup Ramping  $V_{IN}=V_{EN}$ , into Overload, Load= $3\Omega$ ,  $5ms/div$ .

## Operation Description

FAN5362 is a 500mA or 750mA, step-down switching voltage regulator that delivers a fixed output voltage from an input voltage supply up to 5.5V. Using a proprietary architecture with synchronous rectification, FAN5362 is capable of delivering a peak efficiency above 96%, while maintaining efficiency above 90% at load currents as low as 1mA. The regulator operates at a nominal frequency of 3MHz at full load, which reduces the value of the external components to 1 $\mu$ H for the inductor and 4.7 $\mu$ F for the output capacitor. High efficiency is maintained at light load with single-pulse PFM mode.

## Control Scheme

The FAN5362 uses a proprietary, non-linear, fixed-frequency PWM modulator to deliver a fast load transient response, while maintaining a constant switching frequency over a wide range of operating conditions. The regulator performance is independent of the output capacitor ESR, allowing for the use of ceramic output capacitors. Although this type of operation normally results in a switching frequency that varies with input voltage and load current, an internal frequency loop holds the switching frequency constant over a large range of input voltages and load currents.

For very light loads, the FAN5362 operates in discontinuous current (DCM) single-pulse PFM mode, which produces low output ripple compared with other PFM architectures. Transition between PWM and PFM is seamless, with a glitch of less than 18mV at  $V_{OUT}$  during the transition between DCM and CCM modes.

Combined with exceptional transient response characteristics, the very low quiescent current of the controller (45 $\mu$ A) maintains high efficiency, even at very light loads, while preserving fast transient response for applications requiring tight output regulation.

## 100% Duty Cycle Operation

When  $V_{IN}$  approaches  $V_{OUT}$ , the regulator increases its duty cycle until 100% duty cycle is reached. As the duty cycle approaches 100%, the switching frequency declines due to the minimum off-time ( $t_{OFF(MIN)}$ ) of about 35ns imposed by the control circuit. When 100% duty cycle is reached,  $V_{OUT}$  follows  $V_{IN}$  with a drop-out voltage ( $V_{DROPOUT}$ ) determined by the total resistance between  $V_{IN}$  and  $V_{OUT}$ :

$$V_{DROPOUT} = I_{LOAD} \cdot (PMOS R_{DS(ON)} + DCR_L) \quad (1)$$

To calculate the worst-case  $V_{DROPOUT}$ , use the maximum PMOS  $R_{DS(ON)}$  at high temperature from Figure 6.

## Enable and Soft Start

When the EN pin is LOW, the IC is shut down and the part draws very little current. In addition, during shutdown, FB is actively discharged to ground through a 230 $\Omega$  path. Raising EN above its threshold voltage activates the part and starts the soft-start cycle. During soft-start, the internal reference is ramped using an exponential RC shape to prevent any overshoot of the output voltage. Current limiting minimizes inrush during soft-start.

Synchronous rectification is inhibited during soft-start, allowing the IC to start into a pre-charged load.

The IC may fail to start if heavy load is applied during startup and/or if excessive  $C_{OUT}$  is used. This is due to the current-limit fault response, which protects the IC in the event of an over-current condition present during soft-start.

The current required to charge  $C_{OUT}$  during soft-start is commonly referred to as “displacement current” and given as:

$$I_{DISP} = C_{OUT} \cdot \frac{dV}{dt} \quad (2)$$

where  $\frac{dV}{dt}$  refers to the soft-start slew rate.

To prevent shutdown during soft-start, the following condition must be met:

$$I_{DISP} + I_{LOAD} < I_{MAX(DC)} \quad (3)$$

where  $I_{MAX(DC)}$  is the maximum load current the IC is guaranteed to support (500mA or 750mA).

## MODE Pin

Logic 1 on this pin forces the IC to stay in PWM mode. A logic 0 allows the IC to automatically switch to PFM during light loads. If the MODE pin is toggled, the converter synchronizes its switching frequency to four times the frequency on the mode pin ( $f_{MODE}$ ).

At startup, the mode pin must be held LOW or HIGH for at least 10 $\mu$ s to ensure that the converter does not attempt to synchronize to this pin.

## Under-Voltage Lockout

When EN is HIGH, the under-voltage lockout keeps the part from operating until the input supply voltage rises high enough to properly operate. This ensures no misbehavior of the regulator during startup or shutdown.

## Current Limiting

A heavy load or short circuit on the output causes the current in the inductor to increase until a maximum current threshold is reached in the high-side switch. Upon reaching this point, the high-side switch turns off, preventing high currents from causing damage. 16 consecutive PWM cycles in current limit causes the regulator to shut down and stay off for about 2900 $\mu$ s before attempting a restart.

In the event of a short circuit, the soft-start circuit attempts to restart at 240 $\mu$ s, which results in a duty cycle of less than 10%, providing current into a short.

The closed-loop peak-current limit,  $I_{LIM(PK)}$ , is not the same as the open-loop tested current limit,  $I_{LIM(OL)}$ , in the Electrical Characteristics table. This is primarily due to the effect of propagation delays of the IC current limit comparator.

## Thermal Shutdown

When the die temperature increases, due to a high load condition and/or a high ambient temperature, the output switching is disabled until the temperature on the die has fallen sufficiently. The junction temperature at which the thermal shutdown activates is nominally 150°C with a 20°C hysteresis.

## Minimum Off-Time Effect on Switching Frequency

$t_{OFF(MIN)}$  is 35ns. This imposes constraints on the maximum  $\frac{V_{OUT}}{V_{IN}}$  that the FAN5362 can provide, or the maximum output voltage it can provide at low  $V_{OUT}$  while maintaining a fixed switching frequency in PWM mode.

When  $V_{IN}$  is high, fixed switching is maintained as long as  $\frac{V_{OUT}}{V_{IN}} \leq 1 - t_{OFF(MIN)} \cdot f_{SW} \approx 0.7$ .

The switching frequency drops when the regulator cannot provide sufficient duty cycle at 3MHz to maintain regulation. This occurs when  $V_{IN}$  is below 3.3V at nominal load currents.

The calculation for switching frequency is given by:

$$f_{SW} = \min\left(\frac{1}{t_{SW(MAX)}}, 3\text{MHz}\right) \quad (4)$$

where:

$$t_{SW(MAX)} = 35\text{ns} \cdot \left(1 + \frac{V_{OUT} + I_{OUT} \cdot R_{OFF}}{V_{IN} - I_{OUT} \cdot R_{ON} - V_{OUT}}\right) \quad (5)$$

where:

$$R_{OFF} = R_{DSON\_N} + DCR_L$$

$$R_{ON} = R_{DSON\_P} + DCR_L$$

## Applications Information

### Selecting the Inductor

The output inductor must meet both the required inductance and the energy handling capability of the application.

The inductor value affects the average current limit, the PWM-to-PFM transition point, the output voltage ripple, and the efficiency.

The ripple current ( $\Delta I$ ) of the regulator is:

$$\Delta I \approx \frac{V_{OUT}}{V_{IN}} \cdot \left(\frac{V_{IN} - V_{OUT}}{L \cdot f_{SW}}\right) \quad (6)$$

The maximum average load current,  $I_{MAX(Load)}$  is related to the peak current limit,  $I_{LIM(PK)}$  by the ripple current:

$$I_{MAX(Load)} = I_{LIM(PK)} - \frac{\Delta I}{2} \quad (7)$$

The FAN5362 is optimized for operation with  $L=1\mu\text{H}$ , but is stable with inductances up to 1.5 $\mu\text{H}$  (nominal) and down to 470nH. The inductor should be rated to maintain at least 80% of its value at  $I_{LIM(PK)}$ . Failure to do so lowers the amount of DC current that the IC can deliver.

Efficiency is affected by the inductor DCR and inductance value. Decreasing the inductor value for a given physical size typically decreases the DCR; but since  $\Delta I$  increases, the RMS current increases, as do the core and skin effect losses.

$$I_{RMS} = \sqrt{I_{OUT(DC)}^2 + \frac{\Delta I^2}{12}} \quad (8)$$

The increased RMS current produces higher losses through the  $R_{DS(ON)}$  of the IC MOSFETs as well as the inductor ESR.

Increasing the inductor value produces lower RMS currents, but degrades transient response. For a given physical inductor size, increased inductance usually results in an inductor with lower saturation current and higher DCR.

### Inductor Current Rating

The FAN5362's current limit circuit can allow a peak current of 1.25A to flow through L1 under worst-case conditions. If it is possible for the load to draw that much continuous current, the inductor should be capable of sustaining that current or failing in a safe manner.

### Output Capacitor

While 4.7 $\mu\text{F}$  capacitors are available in 0402 package size, 0603 capacitors are recommended due to the severe DC voltage bias degradation in capacitance value that the 0402 exhibits.

Increasing  $C_{OUT}$  has no effect on loop stability and can therefore be increased to reduce output voltage ripple or to improve transient response. Output voltage ripple,  $\Delta V_{OUT}$ , is:

$$\Delta V_{OUT} = \Delta I \cdot \left(\frac{1}{8 \cdot C_{OUT} \cdot f_{SW}} + ESR\right) \quad (9)$$

If values greater than 24 $\mu\text{F}$  of  $C_{OUT}$  are used, the regulator may fail to start. See the sections on *Enable and Soft Start* for more information.

### Input Capacitor

The 2.2 $\mu\text{F}$  ceramic input capacitor should be placed as close as possible to the  $V_{IN}$  pin and GND to minimize the parasitic inductance. If a long wire is used to bring power to the IC, additional "bulk" capacitance (electrolytic or tantalum) should be placed between  $C_{IN}$  and the power source lead to reduce ringing that can occur between the inductance of the power source leads and  $C_{IN}$ .

## PCB Layout Guidelines

There are only three external components: the inductor, input capacitor, and the output capacitor. For any buck switcher IC, including the FAN5362, it is important to place a low-ESR input capacitor very close to the IC, as shown in Figure 26. The input capacitor ensures good input decoupling, which helps reduce noise appearing at the output terminals and ensures that the control sections of the IC do not behave erratically due to excessive noise. This reduces switching cycle jitter and ensures good overall performance. It is important to place the common GND of  $C_{IN}$  and  $C_{OUT}$  as close as possible to the C2 terminal. There is some flexibility in moving the inductor further away from the IC; in that case,  $V_{OUT}$  should be considered at the  $C_{OUT}$  terminal.

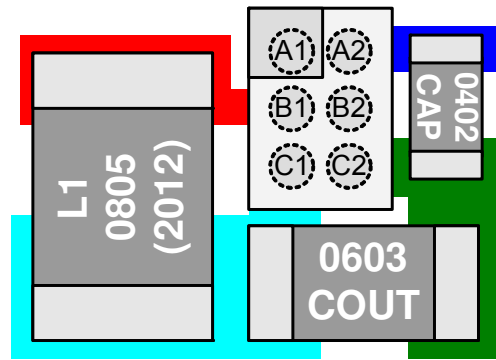
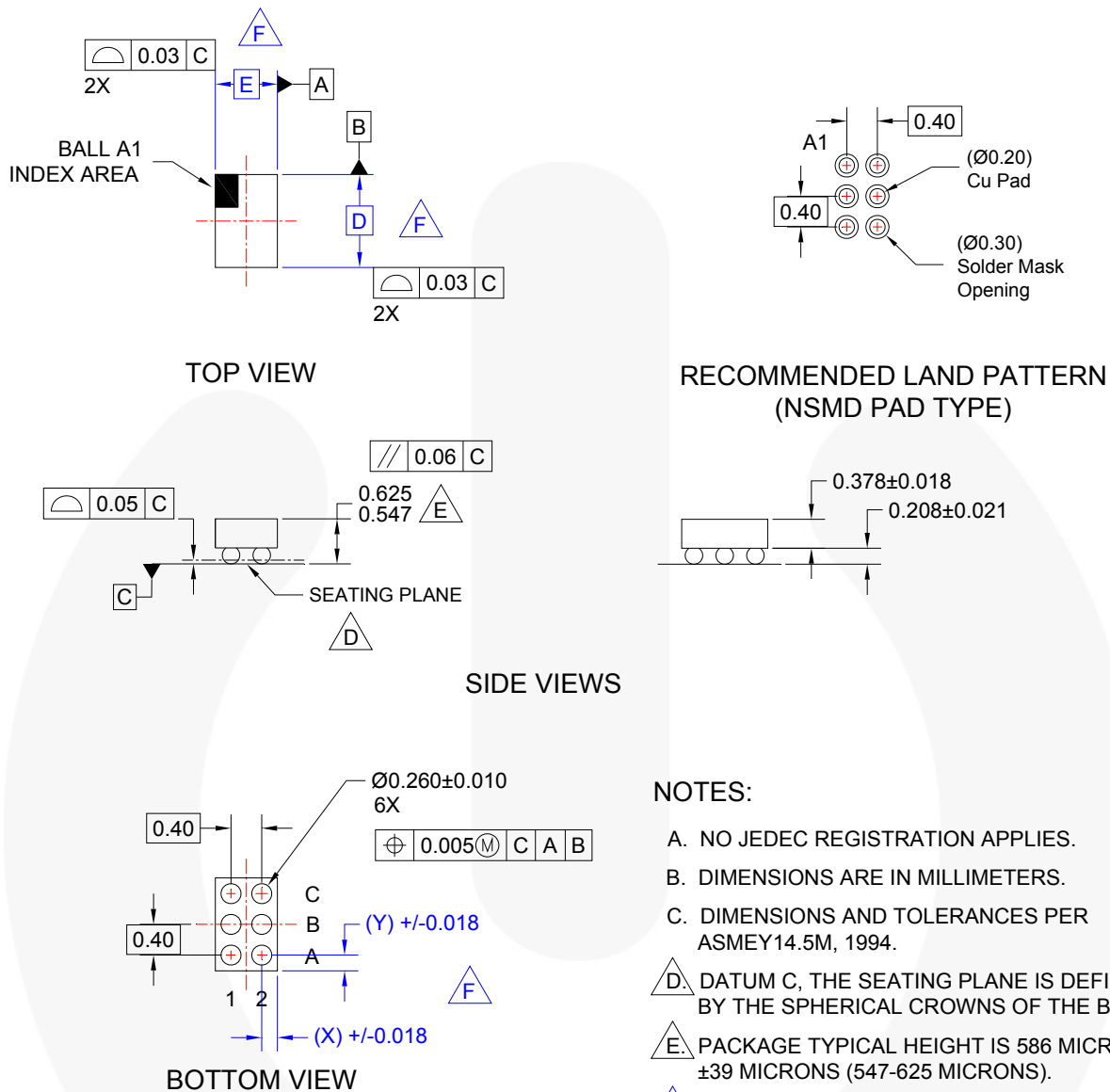

Figure 26. PCB Layout Recommendation



### Physical Dimensions



#### NOTES:

- A. NO JEDEC REGISTRATION APPLIES.
- B. DIMENSIONS ARE IN MILLIMETERS.
- C. DIMENSIONS AND TOLERANCES PER ASMEY14.5M, 1994.
- D. DATUM C, THE SEATING PLANE IS DEFINED BY THE SPHERICAL CROWNS OF THE BALLS.
- E. PACKAGE TYPICAL HEIGHT IS 586 MICRONS ±39 MICRONS (547-625 MICRONS).
- F. FOR DIMENSIONS D, E, X, AND Y SEE PRODUCT DATASHEET.
- G. DRAWING FILENAME: UC006ACrev4.

Figure 27. 6-Ball, Wafer-Level Chip-Scale Package (WLCSP), 2x3 Array, 0.4mm Pitch, 250µm Ball

### Product-Specific Dimensions

Product	D	E	X	Y
FAN5362UCX	1.310 +/-0.030	0.960 +/-0.030	0.280	0.255

Package drawings are provided as a service to customers considering Fairchild components. Drawings may change in any manner without notice. Please note the revision and/or date on the drawing and contact a Fairchild Semiconductor representative to verify or obtain the most recent revision. Package specifications do not expand the terms of Fairchild's worldwide terms and conditions, specifically the warranty therein, which covers Fairchild products.

Always visit Fairchild Semiconductor's online packaging area for the most recent package drawings:  
<http://www.fairchildsemi.com/packaging/>.

# Physical Dimensions

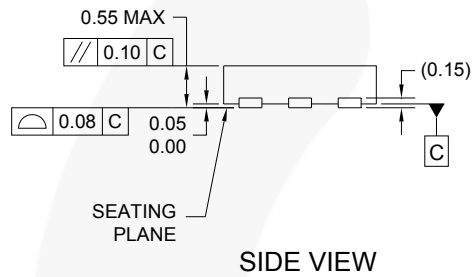
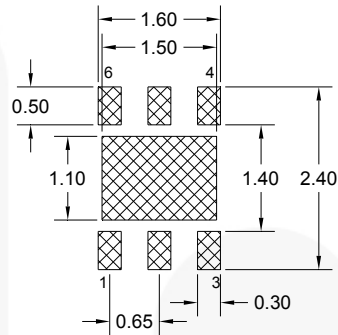
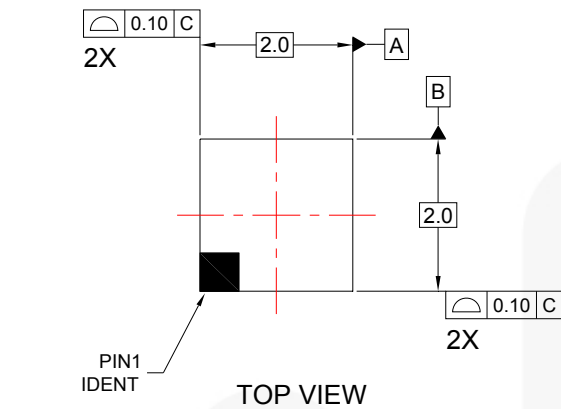

## NOTES:

- A. OUTLINE BASED ON JEDEC REGISTRATION MO-229, VARIATION VCCC.
- B. DIMENSIONS ARE IN MILLIMETERS.
- C. DIMENSIONS AND TOLERANCES PER ASME Y14.5M, 1994.
- D. DRAWING FILENAME: MKT-UMLP06Crev1

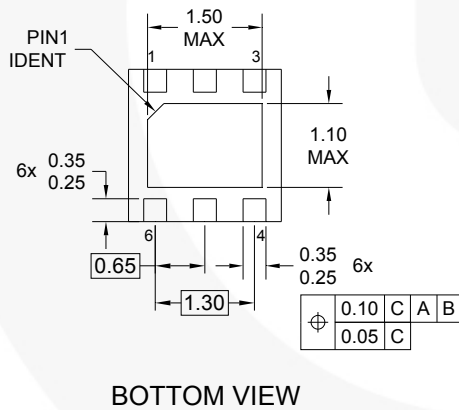

Figure 28. 6-Lead, 2 x 2mm, Ultra-Thin Molded Leadless Package (UMLP)



Package drawings are provided as a service to customers considering Fairchild components. Drawings may change in any manner without notice. Please note the revision and/or date on the drawing and contact a Fairchild Semiconductor representative to verify or obtain the most recent revision. Package specifications do not expand the terms of Fairchild's worldwide terms and conditions, specifically the warranty therein, which covers Fairchild products.

Always visit Fairchild Semiconductor's online packaging area for the most recent package drawings:  
<http://www.fairchildsemi.com/packaging/>.



**TRADEMARKS**

The following includes registered and unregistered trademarks and service marks, owned by Fairchild Semiconductor and/or its global subsidiaries, and is not intended to be an exhaustive list of all such trademarks.

- |  |  |  |   |
|--|--|--|---|
| 2Cool™   | F-PFS™   | PowerTrench®   | The Power Franchise®  |
| AccuPower™   | FRFET®   | PowerXS™   | the power franchise   |
| AX-CAP™*   | Global Power Resource™                         | Programmable Active Droop™   | TinyBoost™  |
| BitSiC™  | GreenBridge™                                   | QFET®  | TinyBuck™   |
| Build it Now™  | Green FPS™                                     | QS™  | TinyCalc™   |
| CorePLUS™  | Green FPS™ e-Series™                           | Quiet Series™  | TinyLogic®  |
| CorePOWER™   | Gmax™  | RapidConfigure™  | TINYOPTO™   |
| CROSSVOLT™   | GTO™   |  ™                | TinyPower™  |
| CTL™   | IntelliMAX™                                    | Saving our world, 1mW/W/kW at a time™  | TinyPower™  |
| Current Transfer Logic™  | ISOPLANAR™                                     | SignalWise™  | TinyPWM™  |
| DEUXPEED®  | Making Small Speakers Sound Louder and Better™ | SmartMax™  | TinyWire™   |
| Dual Cool™   | MegaBuck™                                      | SMART START™   | TranSiC™  |
| EcoSPARK®  | MICROCOUPLER™                                  | Solutions for Your Success™  | TriFault Detect™  |
| EfficientMax™  | MicroFET™                                      | SPM®   | TRUECURRENT®*   |
| ESBC™  | MicroPak™                                      | STEALTH™   | µSerDes™  |
|  Fairchild® | MicroPak2™                                     | SuperFET®  |  SerDes™ |
| Fairchild Semiconductor®   | MillerDrive™                                   | SuperSOT™-3  | UHC®  |
| FACT Quiet Series™   | MotionMax™                                     | SuperSOT™-6  | Ultra FRFET™  |
| FACT®  | mWSaver™                                       | SuperSOT™-8  | UniFET™   |
| FAST®  | OptoHiT™                                       | SupreMOS®  | VCX™  |
| FastvCore™   | OPTOLOGIC®                                     | SyncFET™   | VisualMax™  |
| FETBench™  | OPTOPLANAR®                                    | Sync-Lock™   | VoltagePlus™  |
| FlashWriter®*  |  |  SYSTEM GENERAL®* | XS™   |
| FPS™   |  |  |   |

\* Trademarks of System General Corporation, used under license by Fairchild Semiconductor.

**DISCLAIMER**

FAIRCHILD SEMICONDUCTOR RESERVES THE RIGHT TO MAKE CHANGES WITHOUT FURTHER NOTICE TO ANY PRODUCTS HEREIN TO IMPROVE RELIABILITY, FUNCTION, OR DESIGN. FAIRCHILD DOES NOT ASSUME ANY LIABILITY ARISING OUT OF THE APPLICATION OR USE OF ANY PRODUCT OR CIRCUIT DESCRIBED HEREIN; NEITHER DOES IT CONVEY ANY LICENSE UNDER ITS PATENT RIGHTS, NOR THE RIGHTS OF OTHERS. THESE SPECIFICATIONS DO NOT EXPAND THE TERMS OF FAIRCHILD'S WORLDWIDE TERMS AND CONDITIONS, SPECIFICALLY THE WARRANTY THEREIN, WHICH COVERS THESE PRODUCTS.

**LIFE SUPPORT POLICY**

FAIRCHILD'S PRODUCTS ARE NOT AUTHORIZED FOR USE AS CRITICAL COMPONENTS IN LIFE SUPPORT DEVICES OR SYSTEMS WITHOUT THE EXPRESS WRITTEN APPROVAL OF FAIRCHILD SEMICONDUCTOR CORPORATION.

As used herein:

1. Life support devices or systems are devices or systems which, (a) are intended for surgical implant into the body or (b) support or sustain life, and (c) whose failure to perform when properly used in accordance with instructions for use provided in the labeling, can be reasonably expected to result in a significant injury of the user.
2. A critical component in any component of a life support, device, or system whose failure to perform can be reasonably expected to cause the failure of the life support device or system, or to affect its safety or effectiveness.

**ANTI-COUNTERFEITING POLICY**

Fairchild Semiconductor Corporation's Anti-Counterfeiting Policy. Fairchild's Anti-Counterfeiting Policy is also stated on our external website, [www.fairchildsemi.com](http://www.fairchildsemi.com), under Sales Support.

Counterfeiting of semiconductor parts is a growing problem in the industry. All manufacturers of semiconductor products are experiencing counterfeiting of their parts. Customers who inadvertently purchase counterfeit parts experience many problems such as loss of brand reputation, substandard performance, failed applications, and increased cost of production and manufacturing delays. Fairchild is taking strong measures to protect ourselves and our customers from the proliferation of counterfeit parts. Fairchild strongly encourages customers to purchase Fairchild parts either directly from Fairchild or from Authorized Fairchild Distributors who are listed by country on our web page cited above. Products customers buy either from Fairchild directly or from Authorized Fairchild Distributors are genuine parts, have full traceability, meet Fairchild's quality standards for handling and storage and provide access to Fairchild's full range of up-to-date technical and product information. Fairchild and our Authorized Distributors will stand behind all warranties and will appropriately address any warranty issues that may arise. Fairchild will not provide any warranty coverage or other assistance for parts bought from Unauthorized Sources. Fairchild is committed to combat this global problem and encourage our customers to do their part in stopping this practice by buying direct or from authorized distributors.

**PRODUCT STATUS DEFINITIONS**

**Definition of Terms**

Datasheet Identification	Product Status	Definition
Advance Information	Formative / In Design	Datasheet contains the design specifications for product development. Specifications may change in any manner without notice.
Preliminary	First Production	Datasheet contains preliminary data; supplementary data will be published at a later date. Fairchild Semiconductor reserves the right to make changes at any time without notice to improve design.
No Identification Needed	Full Production	Datasheet contains final specifications. Fairchild Semiconductor reserves the right to make changes at any time without notice to improve the design.
Obsolete	Not In Production	Datasheet contains specifications on a product that is discontinued by Fairchild Semiconductor. The datasheet is for reference information only.

Rev. I62

ON Semiconductor and  are trademarks of Semiconductor Components Industries, LLC dba ON Semiconductor or its subsidiaries in the United States and/or other countries. ON Semiconductor owns the rights to a number of patents, trademarks, copyrights, trade secrets, and other intellectual property. A listing of ON Semiconductor's product/patent coverage may be accessed at [www.onsemi.com/site/pdf/Patent-Marking.pdf](http://www.onsemi.com/site/pdf/Patent-Marking.pdf). ON Semiconductor reserves the right to make changes without further notice to any products herein. ON Semiconductor makes no warranty, representation or guarantee regarding the suitability of its products for any particular purpose, nor does ON Semiconductor assume any liability arising out of the application or use of any product or circuit, and specifically disclaims any and all liability, including without limitation special, consequential or incidental damages. Buyer is responsible for its products and applications using ON Semiconductor products, including compliance with all laws, regulations and safety requirements or standards, regardless of any support or applications information provided by ON Semiconductor. "Typical" parameters which may be provided in ON Semiconductor data sheets and/or specifications can and do vary in different applications and actual performance may vary over time. All operating parameters, including "Typicals" must be validated for each customer application by customer's technical experts. ON Semiconductor does not convey any license under its patent rights nor the rights of others. ON Semiconductor products are not designed, intended, or authorized for use as a critical component in life support systems or any FDA Class 3 medical devices or medical devices with a same or similar classification in a foreign jurisdiction or any devices intended for implantation in the human body. Should Buyer purchase or use ON Semiconductor products for any such unintended or unauthorized application, Buyer shall indemnify and hold ON Semiconductor and its officers, employees, subsidiaries, affiliates, and distributors harmless against all claims, costs, damages, and expenses, and reasonable attorney fees arising out of, directly or indirectly, any claim of personal injury or death associated with such unintended or unauthorized use, even if such claim alleges that ON Semiconductor was negligent regarding the design or manufacture of the part. ON Semiconductor is an Equal Opportunity/Affirmative Action Employer. This literature is subject to all applicable copyright laws and is not for resale in any manner.

## PUBLICATION ORDERING INFORMATION

### LITERATURE FULFILLMENT:

Literature Distribution Center for ON Semiconductor  
19521 E. 32nd Pkwy, Aurora, Colorado 80011 USA  
**Phone:** 303-675-2175 or 800-344-3860 Toll Free USA/Canada  
**Fax:** 303-675-2176 or 800-344-3867 Toll Free USA/Canada  
**Email:** [orderlit@onsemi.com](mailto:orderlit@onsemi.com)

**N. American Technical Support:** 800-282-9855 Toll Free  
USA/Canada  
**Europe, Middle East and Africa Technical Support:**  
Phone: 421 33 790 2910  
**Japan Customer Focus Center**  
Phone: 81-3-5817-1050

**ON Semiconductor Website:** [www.onsemi.com](http://www.onsemi.com)  
**Order Literature:** <http://www.onsemi.com/orderlit>  
For additional information, please contact your local  
Sales Representative