

MAX14646E

USB Charger Detection with Integrated Overvoltage Protector

General Description

The MAX14646E is a USB charger detector which includes advanced features from USB Battery Charging Specification Revision 1.2. The USB charger detection circuitry detects USB standard downstream ports (SDPs), USB charging downstream ports (CDPs), or dedicated charger ports (DCPs), and controls an external lithium-ion (Li+) battery charger.

The device implements USB Battery Charging Specification detection logic. It also includes Apple® charger detection that allows identification of resistor divider networks on D+/D-.

The internal double-pole double-throw (DPDT) USB switch is compliant to Hi-Speed USB, full-speed USB, low-speed USB, and UART signals. The device's internal switch features low on-resistance, low on-resistance flatness, and very low capacitance. The ID pin controls the DPDT switch position. The MAX14646E features high-ESD protection up to ±15kV Human Body Model (HBM) on the CD+, CD-, and ID pins.

The IC is available in a 16-bump, 0.4mm pitch, 1.8mm x 1.9mm WLP package and operates over the -40°C to +85°C extended temperature range.

Applications

- DSCs and Camcorders
- Tablet PCs
- Smartphones
- e-Readers

Benefits and Features

- Consumes Less Power
 - Low Battery Standby Current 5µA (typ)
- Delivers USB Compliance and Flexibility
 - Includes Advanced Features from USB Battery Charging Specification Revision 1.2
 - Data Contact Detection for Foolproof Connector Insertion Detection
 - Dedicated Charger Detection
 - Standard Downstream Port Detection
 - Charging Downstream Port Detection
 - Apple Charger Detection
 - Sony® Charger Detection*
- Facilitates System Design
 - Integrated Precision 1.5A Overvoltage Protection (OVP)
 - Negative Audio Capable DPDT Hi-Speed USB Switches
 - Automatic Switch and Charger Interface Control
 - Full Control by I²C Interface
 - Interrupt for Device Status Change
- Saves Board Space
 - V_{BUS} Connection Capable of 36V
 - ±15kV HBM ESD Protection
 - 1.8mm x 1.9mm WLP Package

Ordering Information appears at end of data sheet.

Typical Operating Circuit appears at end of data sheet.

*Contact factory for the list of compatible chargers.

Apple is a registered trademark of Apple, Inc.

Sony is a registered trademark and registered service mark of Kabushiki Kaisha TA Sony Corporation.



Absolute Maximum Ratings

(Voltages referenced to GND.)
 BAT, INT, SDA, SCL, CE, ID, IDBF.....-0.3V to +6.0V
 OUT.....-0.3V to Minimum ($V_B + 0.3V, +6.0V$)
 V_B-0.3V to +40V
 CP_EN = 1 (Note 1)
 CD+, CD-, UT, UR.....-2.1V to ($V_{SWPOS} + 0.3V$)
 TD+, TD-.....-0.3V to ($V_{SWPOS} + 0.3V$)
 CP_EN = 0 (Note 2)
 CD+, CD-, TD+, TD-, UT, UR.....-0.3V to ($V_{CCINT} + 0.3V$)

Continuous Current into V_B , OUT.....±1.5A
 Continuous Current into Any Other Terminal.....±50mA
 Continuous Power Dissipation ($T_A = +70^\circ C$)
 WLP (derate 17.2mW/ $^\circ C$ above +70 $^\circ C$).....1376mW
 Operating Temperature Range.....-40 $^\circ C$ to +85 $^\circ C$
 Junction Temperature.....+150 $^\circ C$
 Storage Temperature Range.....-65 $^\circ C$ to +150 $^\circ C$
 Soldering Temperature (reflow).....+260 $^\circ C$

Note 1: $V_{SWPOS} = \min(V_{CCINT} \text{ or } 3.3V)$.
Note 2: $V_{CCINT} = \max(V_{BAT} \text{ or } \min(V_B \text{ or } 3.7V))$.

Stresses beyond those listed under "Absolute Maximum Ratings" may cause permanent damage to the device. These are stress ratings only, and functional operation of the device at these or any other conditions beyond those indicated in the operational sections of the specifications is not implied. Exposure to absolute maximum rating conditions for extended periods may affect device reliability.

Package Thermal Characteristics (Note 3)

WLP
 Junction-to-Ambient Thermal Resistance (θ_{JA}).....58 $^\circ C/W$

Note 3: Package thermal resistances were obtained using the method described in JEDEC specification JESD51-7, using a four-layer board. For detailed information on package thermal considerations, refer to www.maximintegrated.com/thermal-tutorial.

Electrical Characteristics

($V_{BAT} = +2.8V$ to +5.5V, $V_B = +3.5V$ to +36V, $T_A = -40^\circ C$ to +85 $^\circ C$, unless otherwise noted. Typical values are at $V_{BAT} = +3.6V$, $V_B = +5.0V$, $T_A = +25^\circ C$.) (Note 4)

| PARAMETER | SYMBOL | CONDITIONS | MIN | TYP | MAX | UNITS |
|------------------------------------|-------------|--|-------|-------|------|---------|
| DC CHARACTERISTICS | | | | | | |
| Supply Voltage Range | V_{BAT} | | 2.8 | | 5.5 | V |
| | V_B | | 3.5 | | 36 | |
| Internal Positive Switch Regulator | V_{SWPOS} | | 3.3 | 3.4 | 3.5 | V |
| Internal Negative Switch Regulator | V_{SWNEG} | | -2.08 | -1.97 | -1.8 | V |
| POR | V_{CCINT} | Rising edge | 0.5 | 1.6 | 2.6 | V |
| | | Falling edge | | | 2.35 | |
| BAT Supply Current | I_{BAT} | $V_{BAT} = 4.2V, V_B = 0V, CP_EN = 0,$ $USB_SWC = 00, ADC_EN = 0,$ $V_{SDA} = V_{SCL} = 0.4V$ | | 5 | 7.5 | μA |
| | | $V_{BAT} = 4.2V, V_B = 0V, CP_EN = 1,$ $USB_SWC = 11, ADC_EN = 1,$ $V_{SDA} = V_{SCL} = 1.8V$ | | 49 | 80 | |
| V_B Supply Current | I_{VB} | $V_B = 5.5V, CP_EN = 1,$ $USB_SWC = 00$ | | 200 | 360 | μA |

Electrical Characteristics (continued)

($V_{BAT} = +2.8V$ to $+5.5V$, $V_B = +3.5V$ to $+36V$, $T_A = -40^\circ C$ to $+85^\circ C$, unless otherwise noted. Typical values are at $V_{BAT} = +3.6V$, $V_B = +5.0V$, $T_A = +25^\circ C$.) (Note 4)

| PARAMETER | SYMBOL | CONDITIONS | MIN | TYP | MAX | UNITS |
|---|--------------------------------------|--|----------|-------------|-------------|------------|
| OVERVOLTAGE PROTECTION | | | | | | |
| Switch On-Resistance | R_{ON} | $V_B = 5V$, $I_{OUT} = -80mA$ | | 60 | 130 | $m\Omega$ |
| Overvoltage Lockout Cutoff Threshold | V_{OVLO} | Rising edge of V_B | 5.75 | 5.875 | 6.0 | V |
| Overvoltage Lockout Hysteresis | | Falling edge of V_B | 5.50 | | | V |
| OUT Load Capacitance | | I_{OUT} up to 1.5A | 1 | | | μF |
| Thermal Shutdown Threshold | | | | +150 | | $^\circ C$ |
| Thermal Shutdown Hysteresis | | | | 20 | | $^\circ C$ |
| CHARGER DETECTION | | | | | | |
| V_{DAT_SRC} Voltage | V_{DP_SRC} | With $I_{DP_SRC} = 0$ to $200\mu A$ | 0.5 | | 0.7 | V |
| V_{DAT_REF} Voltage | V_{DAT_REF} | | 0.25 | | 0.4 | V |
| V_{LGC} Voltage | V_{LGC} | | 1 | | 1.5 | V |
| I_{DP_SRC} Current | I_{DP_SRC} | 0 to 2.5V | 6 | | 11 | μA |
| R_{DM} Pulldown Resistor | R_{DM_DWN} | | 14.25 | | 24.8 | $k\Omega$ |
| CD+ and CD- Sink Current | I_{CD+_SINK} , I_{CD-_SINK} | 150mV to 3.6V | 50 | | 150 | μA |
| Charger Detection Weak Sink | I_{WEAK} | $V_{CD-} = 3.6V$ | | | 0.3 | μA |
| V_{BUS25} Ratio | V_{BUS25} | Reference ratio for special charger as a percentage of V_{BUS} voltage, $V_B = 5V$ | 22.5 | 25 | 27.5 | % |
| V_{BUS47} Ratio | V_{BUS47} | Reference ratio for special charger as a percentage of V_{BUS} voltage, $V_B = 5V$ | 42.3 | 47 | 51.7 | % |
| V_{BUS60} Ratio | V_{BUS60} | Reference ratio for special charger as a percentage of V_{BUS} voltage, $V_B = 5V$ | 57 | 60 | 63 | % |
| Charger Detect Source Time | $t_{DP_SRC_ON}$ | DCHK_TM = 0 | 40 | | | ms |
| | | DCHK_TM = 1 | | 625 | | |
| Charger Detect Type Detection Time | $t_{DP_RES_ON}$ | From $V_B > V_{VBDET}$ to detection completed | 120 | | | ms |
| Charger Detect Delay Time | $t_{DP_SRC_HICRNT}$ | | 40 | | 80 | ms |
| V_B Attach to \overline{CE} Output Time | t_{VBSW} | From $V_B > V_{VBDET}$ or CHG_TYP_M = 1 to \overline{CE} change, DCHK_TM = 0 | | | 520 | ms |
| | | From $V_B > V_{VBDET}$ or CHG_TYP_M = 1 to \overline{CE} change, DCHK_TM = 1 | | | 1450 | |
| V_B Detect Threshold | V_{VBDET} | Rising edge | 3.3 | 3.4 | 3.5 | V |
| V_B Detect Hysteresis | V_{VBDET_HYS} | | | 400 | | mV |
| USB ANALOG SWITCHES (CD+, CD-) | | | | | | |
| Analog Signal Range | V_{CD+} , V_{CD-} | CP_EN = 0 | | 0 | V_{CCINT} | V |
| | | CP_EN = 1 | TD+, TD- | 0 | V_{SWPOS} | |
| | | | UR, UT | V_{SWNEG} | V_{SWPOS} | |

Electrical Characteristics (continued)

($V_{BAT} = +2.8V$ to $+5.5V$, $V_B = +3.5V$ to $+36V$, $T_A = -40^\circ C$ to $+85^\circ C$, unless otherwise noted. Typical values are at $V_{BAT} = +3.6V$, $V_B = +5.0V$, $T_A = +25^\circ C$.) (Note 4)

| PARAMETER | SYMBOL | CONDITIONS | MIN | TYP | MAX | UNITS |
|--------------------------------------|--------------------|---|------|------|------|----------|
| On-Resistance | R_{ONUSB} | $V_{BAT} = 3.0V$, I_{CD+} or $I_{CD-} = 10mA$, V_{CD+} or $V_{CD-} = 0$ to $3.0V$ | | 3 | 6 | Ω |
| On-Resistance Match Between Channels | ΔR_{ONUSB} | $V_{BAT} = 3.0V$, I_{CD+} or $I_{CD-} = 10mA$, V_{CD+} or $V_{CD-} = 400mV$ | | | 0.5 | Ω |
| On-Resistance Flatness | $R_{FLATUSB}$ | $V_{BAT} = 3.0V$, I_{CD+} or $I_{CD-} = 10mA$, V_{CD+} or $V_{CD-} = 0$ to $3.3V$ | | 0.06 | 0.2 | Ω |
| Off-Leakage Current | $I_{LUSB(OFF)}$ | $V_{BAT} = 4.2V$, switch open; V_{UT} , V_{UR} , V_{TD-} , or $V_{TD+} = 0.3V$, $2.5V$; V_{CD+} or $V_{CD-} = 2.5V$, $0.3V$ | -360 | | +360 | nA |
| On-Leakage Current | $I_{LUSB(ON)}$ | $V_{BAT} = 4.2V$, switch closed; V_{CD-} or $V_{CD+} = 0.3V$, $2.5V$ | -360 | | +360 | nA |

ANALOG INPUT (ID) (Note 5)

| PARAMETER | SYMBOL | CONDITIONS | | MIN | TYP | MAX | UNITS |
|--|-----------|-------------|----------------|-----|-------|-----|------------|
| | | RESISTOR ID | RESISTOR VALUE | | | | |
| ADC Detection Resistors (Use $\pm 1\%$ Resistors for R1 to R30) | R_{ADC} | 00000 | GND | | | 1.5 | k Ω |
| | | 00001 | R1 | | 2.21 | | |
| | | 00010 | R2 | | 2.8 | | |
| | | 00011 | R3 | | 3.48 | | |
| | | 00100 | R4 | | 4.22 | | |
| | | 00101 | R5 | | 5.11 | | |
| | | 00110 | R6 | | 6.04 | | |
| | | 00111 | R7 | | 7.87 | | |
| | | 01000 | R8 | | 10.02 | | |
| | | 01001 | R9 | | 12.1 | | |
| | | 01010 | R10 | | 14.7 | | |
| | | 01011 | R11 | | 17.8 | | |
| | | 01100 | R12 | | 21.5 | | |
| | | 01101 | R13 | | 25.5 | | |
| | | 01110 | R14 | | 30.1 | | |
| | | 01111 | R15 | | 36.5 | | |
| | | 10000 | R16 | | 45.3 | | |
| | | 10001 | R17 | | 53.6 | | |
| | | 10010 | R18 | | 64.9 | | |
| | | 10011 | R19 | | 80.06 | | |
| | | 10100 | R20 | | 102 | | |
| | | 10101 | R21 | | 121 | | |
| | | 10110 | R22 | | 150 | | |
| | | 10111 | R23 | 175 | 200 | 202 | |
| | | 11000 | R24 | | 232 | | |
| | | 11001 | R25 | | 267 | | |
| | | 11010 | R26 | | 309 | | |
| | | 11011 | R27 | | 365 | | |
| | | 11100 | R28 | | 422 | | |
| | | 11101 | R29 | | 491 | | |
| | | 11110 | R30 | | 576 | | |
| 11111 | Open | | 750 | | | | |

Electrical Characteristics (continued)

($V_{BAT} = +2.8V$ to $+5.5V$, $V_B = +3.5V$ to $+36V$, $T_A = -40^\circ C$ to $+85^\circ C$, unless otherwise noted. Typical values are at $V_{BAT} = +3.6V$, $V_B = +5.0V$, $T_A = +25^\circ C$.) (Note 4)

| PARAMETER | SYMBOL | CONDITIONS | MIN | TYP | MAX | UNITS |
|--|----------------|--|-----|-----------------|-----|---------|
| DIGITAL SIGNALS (INT, CE, SCL, SDA) | | | | | | |
| Input Logic-High | V_{IH} | | 1.4 | | | V |
| Input Logic-Low | V_{IL} | | | | 0.4 | V |
| Input Leakage Current | I_{INLEAK} | | -1 | | +1 | μA |
| Output Leakage Current | I_{LEAK} | $V_{IO} = 3.3V$ | | | 1 | μA |
| Output Logic-Low Voltage (INT, CE) | V_{OL} | $I_{SINK} = 1mA$ | | | 0.2 | V |
| DIGITAL OUTPUT (IDBF) | | | | | | |
| Output Logic-High | | $V_{OUT} = 5.5V$, $I_{SOURCE} = 1mA$ | | $V_{OUT} - 0.4$ | 1 | V |
| Output Logic-Low | V_{OL} | $I_{SINK} = 1mA$ | | | 0.4 | V |
| Output Logic High Impedance | I_{LEAK} | | -1 | | +1 | μA |
| DYNAMIC PERFORMANCE | | | | | | |
| Analog-Switch Turn-On Time | t_{ON} | I ² C stop to switch on, $R_L = 50\Omega$ | | 0.02 | 1 | ms |
| Analog-Switch Turn-Off Time | t_{OFF} | I ² C stop to switch off, $R_L = 50\Omega$ | | 0.02 | 0.1 | ms |
| Debounce Time | t_{MDEB} | Main debounce, all comparators | 20 | 30 | 40 | ms |
| Off-Capacitance | C_{OFF} | TD-, TD+ applied voltage is $0.5V_{P-P}$, DC bias = 0V, $f = 240MHz$ | | 2 | | pF |
| On-Capacitance | C_{ON} | TD-, TD+ applied voltage is $0.5V_{P-P}$, DC bias = 0V, $f = 240MHz$, CD- connected to TD-, CD+ connected to TD+ | | 7 | | pF |
| -3dB Bandwidth | BW | | | 1 | | GHz |
| Crosstalk | | $R_L = 50\Omega$, $f = 20kHz$, $V_{CD-} = 0.5V_{P-P}$ | | -80 | | dB |
| Off-Isolation | V_{ISO} | $R_L = 50\Omega$, $f = 20kHz$, $V_{CD-} = 0.5V_{P-P}$ | | -60 | | dB |
| I²C TIMING SPECIFICATIONS (Figure 3) | | | | | | |
| I ² C Maximum Clock | f_{I2C_CLK} | | | 400 | | kHz |
| Bus Free Time Between STOP and START Conditions | t_{BUF} | | 1.3 | | | μs |
| START Condition Setup Time | | | 0.6 | | | μs |
| Repeated START Condition Setup Time | $t_{SU:STA}$ | 90% to 90% | 0.6 | | | μs |
| START Condition Hold Time | $t_{HD:STA}$ | 10% of SDA to 90% of SCL | 0.6 | | | μs |
| STOP Condition Setup Time | $t_{SU:STO}$ | 90% of SCL to 10% of SDA | 0.6 | | | μs |
| Clock Low Period | t_{LOW} | 10% to 10% | 1.3 | | | μs |
| Clock High Period | t_{HIGH} | 90% to 90% | 0.6 | | | μs |
| Data Valid to SCL Rise Time | $t_{SU:DAT}$ | Write setup time | 100 | | | ns |
| Data Hold Time to SCL Fall | $t_{HD:DAT}$ | Write hold time | | | 0 | ns |

Electrical Characteristics (continued)

($V_{BAT} = +2.8V$ to $+5.5V$, $V_B = +3.5V$ to $+36V$, $T_A = -40^\circ C$ to $+85^\circ C$, unless otherwise noted. Typical values are at $V_{BAT} = +3.6V$, $V_B = +5.0V$, $T_A = +25^\circ C$.) (Note 4)

| PARAMETER | SYMBOL | CONDITIONS | MIN | TYP | MAX | UNITS |
|-----------------------|--------|------------------|-----|-----|-----|-------|
| ESD PROTECTION | | | | | | |
| CD+, CD-, ID | | Human Body Model | | ±15 | | kV |
| All Other Pins | | Human Body Model | | ±2 | | kV |

Note 4: All devices are 100% production tested at $T_A = +25^\circ C$. Limits over the operating temperature range are guaranteed by design and not production tested.

Note 5: All resistor values guaranteed to be detected within ±1% range.

Typical Operating Characteristics

($T_A = +25^\circ C$, unless otherwise noted.)

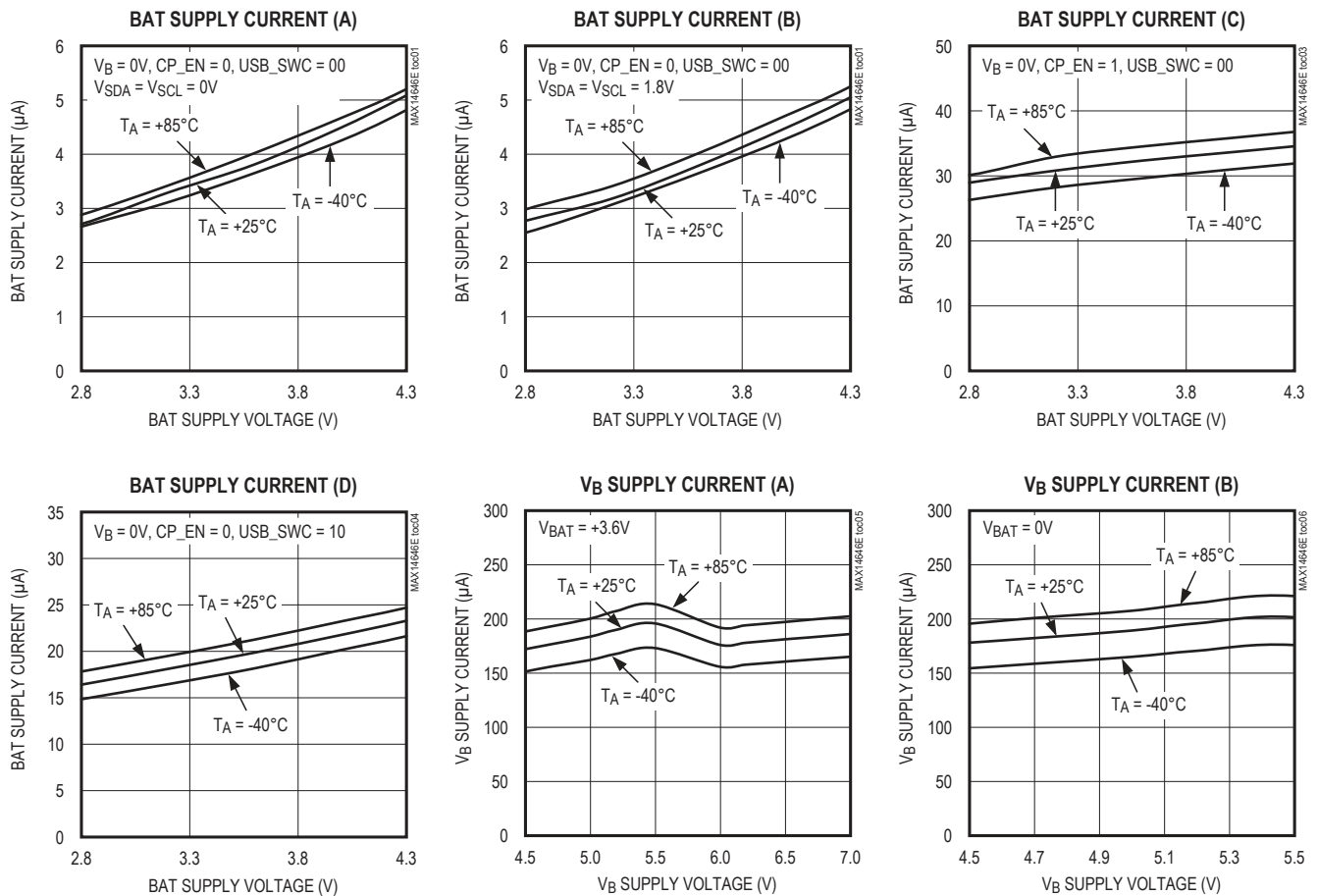

Typical Operating Characteristics (continued)

($T_A = +25^\circ\text{C}$, unless otherwise noted.)

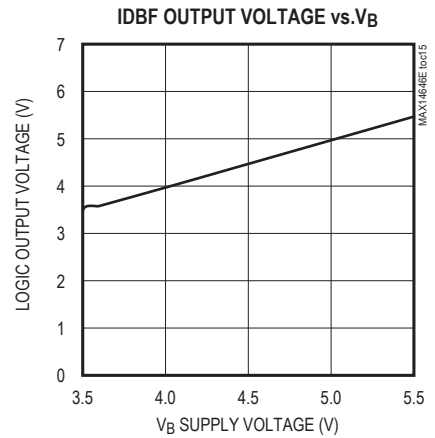
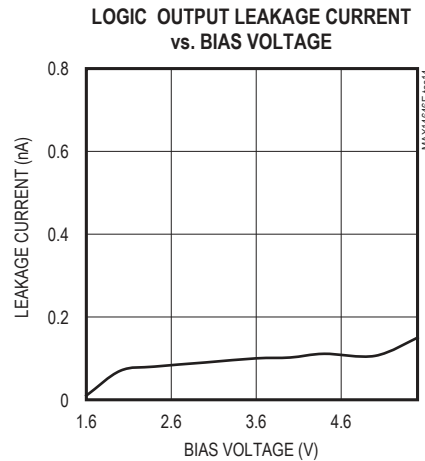
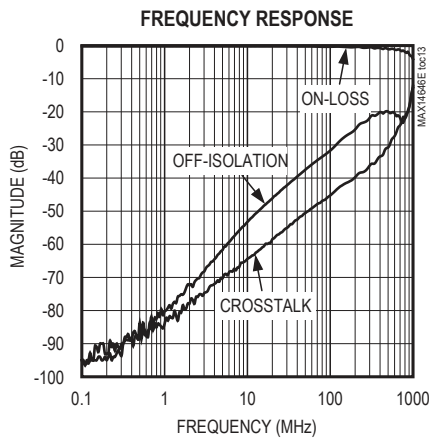
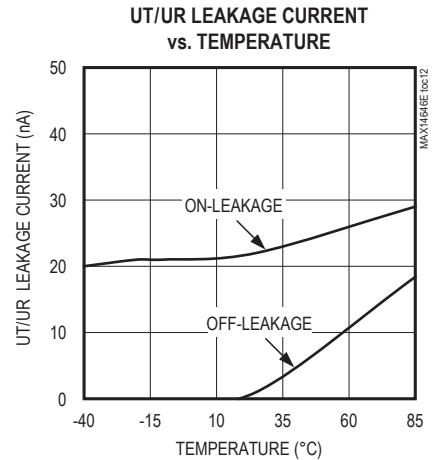
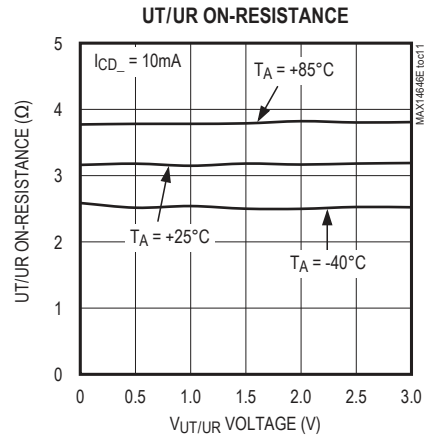
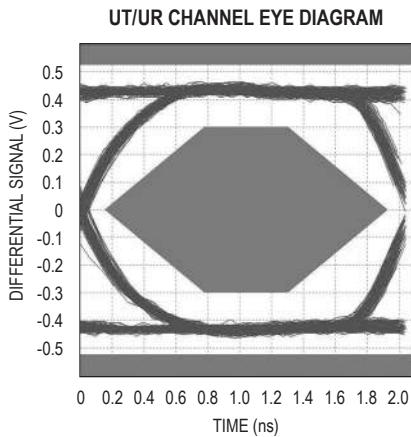
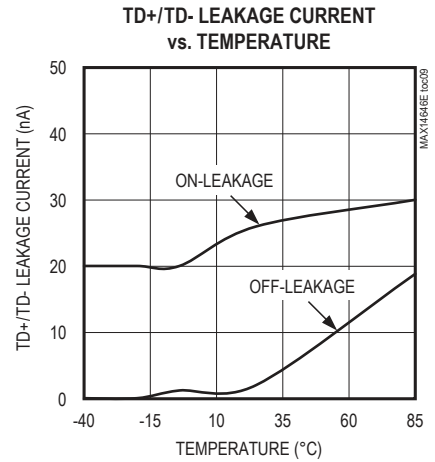
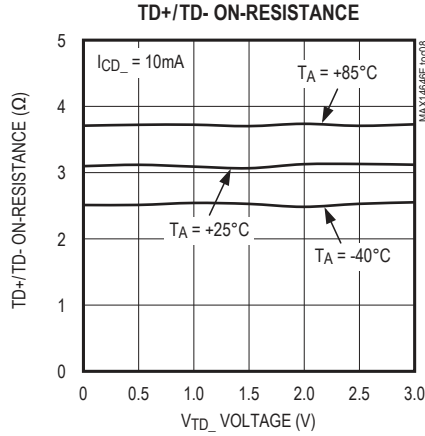
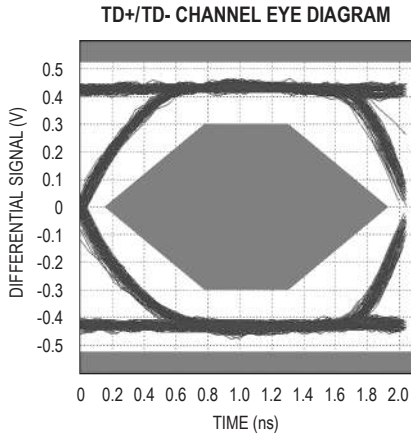

Typical Operating Characteristics (continued)

(TA = +25°C, unless otherwise noted.)

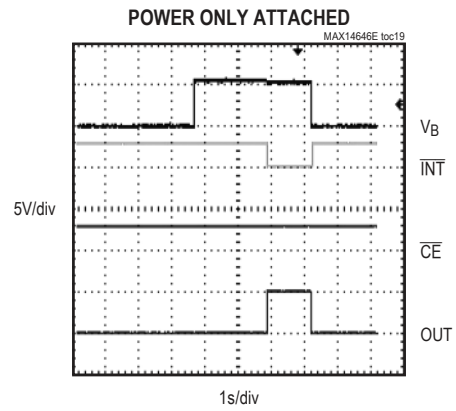
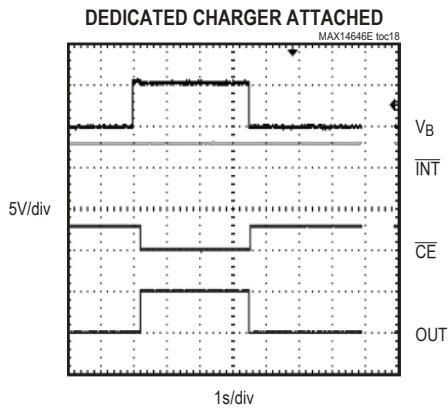
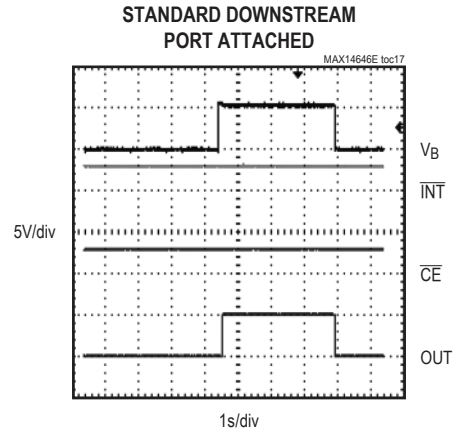
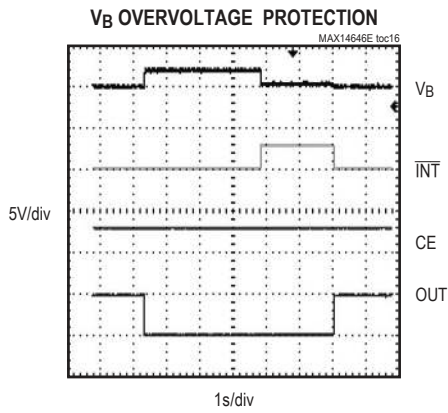

Bump Configuration

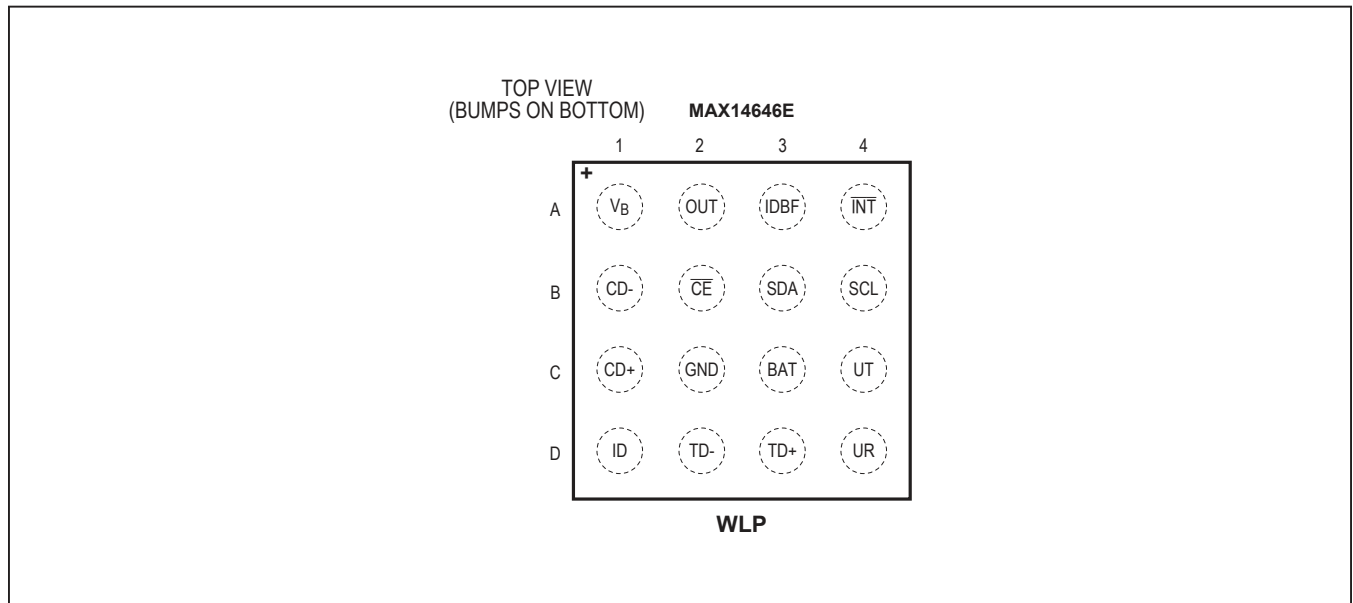

Bump Description

| BUMP | NAME | FUNCTION |
|------|----------------|--|
| A1 | V _B | USB Connector V _{BUS} Connection. Bypass V _B with a 1μF capacitor to GND. |
| A2 | OUT | Overvoltage-Protected USB Transceiver V _{BUS} Power Output. Bypass OUT with a 1μF capacitor to GND. |
| A3 | IDBF | Push-Pull Digital ID Buffer Output |
| A4 | INT | Active-Low, Open-Drain, Interrupt Request Fault Output. Connect INT to an external pullup resistor. |
| B1 | CD- | USB Connector D- Connection |
| B2 | CE | Active-Low, Open-Drain, Charger Control Enable Output. Connect CE to an external pullup resistor. |
| B3 | SDA | I ² C Serial-Data Input/Output. Connect SDA to an external pullup resistor. |
| B4 | SCL | I ² C Serial-Clock Input. Connect SCL to an external pullup resistor. |
| C1 | CD+ | USB Connector D+ Connection |
| C2 | GND | Ground |
| C3 | BAT | Battery Connection Input. Bypass BAT with a 1μF capacitor to GND. |
| C4 | UT | UART Tx Line from Device |
| D1 | ID | USB Connector ID Connection. Bypass ID with a 1nF (max) capacitor to GND. |
| D2 | TD- | USB Transceiver D- Connection |
| D3 | TD+ | USB Transceiver D+ Connection |
| D4 | UR | UART Rx Line from Device |

Functional Diagram

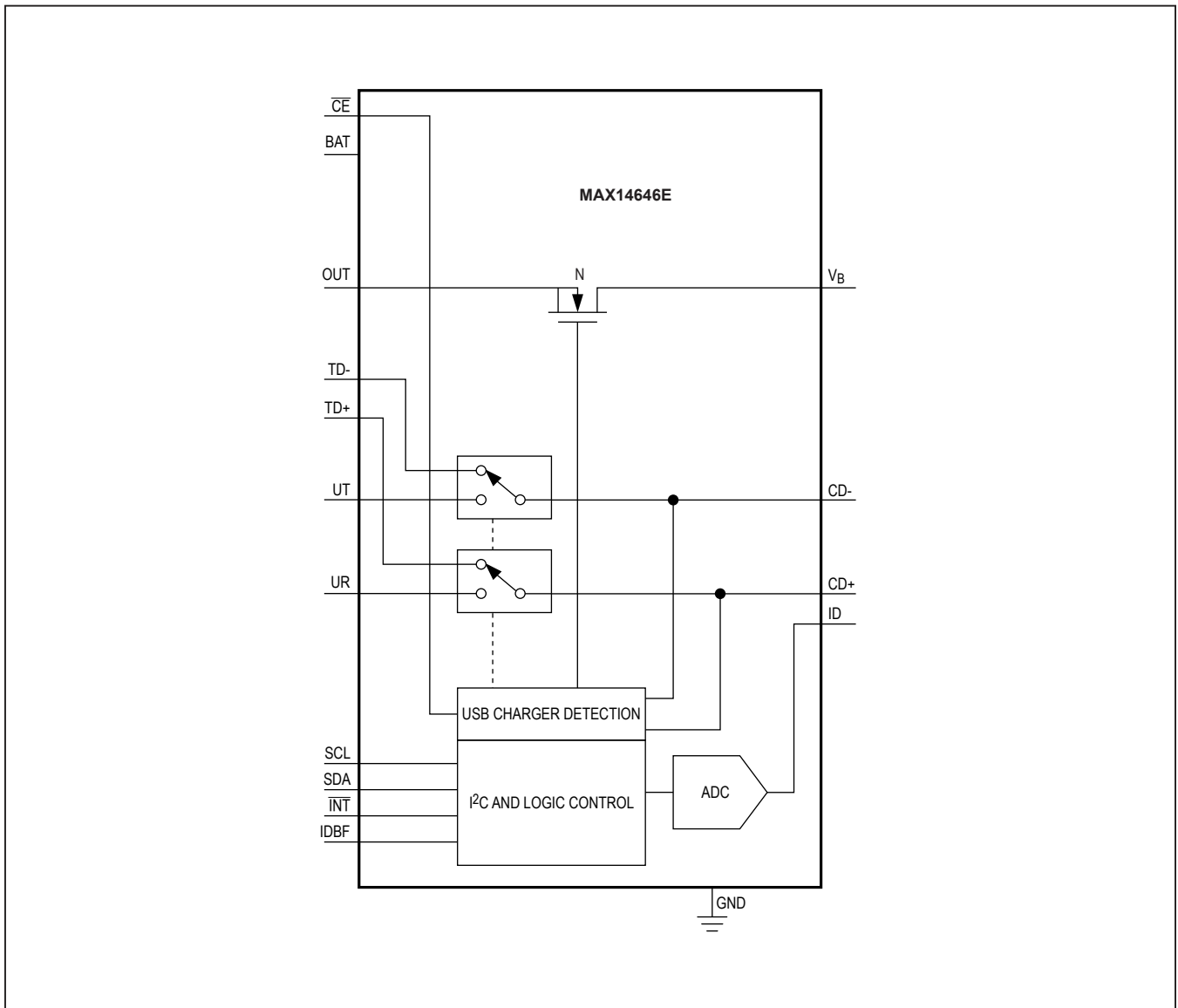

Table 1. Register Map

| ADDRESS | NAME | B7 | B6 | B5 | B4 | B3 | B2 | B1 | B0 |
|---------|-------------|-------------|-----------------|----------------|------------|-----------|---------|-------------|------------|
| 0x00 | DEVICE ID | VENDOR_ID | | | CHIP_REV | | | | |
| 0x01 | INTERRUPT 1 | DCD_TMR | CHG_DET_START | CHG_DET_STOP | RFU | | OVP | VB_VALID | CHG_TYP |
| 0x02 | INTERRUPT 2 | ADC_ERROR | RFU | | | | | | ADC |
| 0x03 | STATUS 1 | DCD_TMR_S | CHG_DET_RUN_S | OVP_S | VB_VALID_S | CHG_TYP_S | | | |
| 0x04 | STATUS 2 | ADC_ERROR_S | RFU | | ADC_S | | | | |
| 0x05 | INTMASK 1 | DCD_TMR_M | CHG_DET_START_M | CHG_DET_STOP_M | RFU | | OVP_M | VB_VALID_M | CHG_TYP_M |
| 0x06 | INTMASK 2 | ADC_ERROR_M | RFU | | | | | | ADC_M |
| 0x07 | CONTROL 1 | INT_TYP | INT_DLY | INT_POL | INT_EN | USB_SWC | | CP_EN | LOW_PWR |
| 0x08 | CONTROL 2 | APPL_NXT | CE_FRC | CE | ADC_DEB | | USB_CPL | ID_AUTO_SWC | ADC_EN |
| 0x09 | CONTROL 3 | OVP_EN | | CDP_DET | DCHK_TM | DCD_2S_CT | DCD_EN | CHG_TYP_MAN | CHG_DET_EN |

Table 2. Detailed Register Map

| FIELD NAME | READ/WRITE | BITS | DEFAULT | DESCRIPTION |
|---------------------------|------------|-------|---------|---|
| DEVICE ID (0x00) | | | | |
| VENDOR_ID | Read only | [7:4] | 0010 | Vendor Identification |
| CHIP_REV | Read only | [3:0] | 0000 | Chip Revision |
| INTERRUPT 1 (0x01) | | | | |
| DCD_TMR | Read only | [7] | 0 | Data Contact Detection Timer Interrupt 0 = No interrupt 1 = Interrupt |
| CHG_DET_START | Read only | [6] | 0 | Charger Detection Start Transition Interrupt 0 = No interrupt 1 = Interrupt |
| CHG_DET_STOP | Read only | [5] | 0 | Charger Detection Stop Transition Interrupt 0 = No interrupt 1 = Interrupt |
| RFU | Read only | [4:3] | 00 | Reserved |
| OVP | Read only | [2] | 0 | Overvoltage Protection Interrupt. When V_B is greater than V_{OVP} , the interrupt is triggered. 0 = No interrupt 1 = Interrupt |
| VB_VALID | Read only | [1] | 0 | V_{BUS} Valid Interrupt. Any change in the VB_VALID_S bit triggers an interrupt. 0 = No interrupt 1 = Interrupt |
| CHG_TYP | Read only | [0] | 0 | Charger Type Interrupt 0 = No interrupt 1 = Interrupt |
| INTERRUPT 2 (0x02) | | | | |
| ADC_ERROR | Read only | [7] | 0 | ADC Error Interrupt 0 = No interrupt 1 = Interrupt |

Table 2. Detailed Register Map (continued)

| FIELD NAME | READ/WRITE | BITS | DEFAULT | DESCRIPTION |
|-------------------------|------------|-------|---------|---|
| RFU | Read only | [6:1] | 000000 | Reserved |
| ADC | Read only | [0] | 0 | ADC Change Interrupt 0 = No interrupt 1 = Interrupt |
| STATUS 1 (0x03) | | | | |
| DCD_TMR_S | Read only | [7] | 0 | Data Contact Detection Timer Wait Status 0 = Data contact detection timer not expired or not running 1 = Data contact detection running for greater than 2s (typ) |
| CHG_DET_RUN_S | Read only | [6] | 0 | Charger Detection State Machine Running Status 0 = Not running 1 = Running |
| OVP_S | Read only | [5] | 0 | V_B Overvoltage Protection Trip Level Indication 0 = V_B is less than or equal to the overvoltage trip level 1 = V_B is greater than the overvoltage trip level |
| VB_VALID_S | Read only | [4] | 0 | V_{BUS} Valid Status 0 = V_B is less than V_{VBDET} or V_B is greater than the overvoltage trip level (OVP_S = 1) 1 = V_B is greater than or equal to the V_{VBDET} and V_B is less than or equal to overvoltage trip level (OVP_S = 0) |
| CHG_TYP_S | Read only | [3:0] | 0000 | USB Charger Detection Output 0000 = Nothing attached 0001 = Standard downstream port (SDP) 0010 = Charging downstream port (CDP) 0011 = Dedicated charger port (DCP) 0100 = Apple 500mA (max) charger 0101 = Apple 1A (max) charger 0110 = Apple 2A (max) charger 0111 = Special 500mA charger 1100 = Apple RFU Other conditions are reserved for future use. |
| STATUS 2 (0x04) | | | | |
| ADC_ERROR_S | Read only | [7] | 0 | ADC Error Status 0 = No ADC error 1 = ADC error |
| RFU | Read only | [6:5] | 00 | Reserved |
| ADC_S | Read only | [4:0] | 11111 | ADC Output. See the ADC Detection Resistors specifications in the <i>Electrical Characteristics</i> table. |
| INTMASK 1 (0x05) | | | | |
| DCD_TMR_M | Read/write | [7] | 0 | Data Contact Detection Timer Interrupt Mask 0 = Mask 1 = Not masked |
| CHG_DET_START_M | Read/write | [6] | 0 | Charger Detection Run Rising Transition Interrupt Mask 0 = Mask 1 = Not masked |

Table 2. Detailed Register Map (continued)

| FIELD NAME | READ/WRITE | BITS | DEFAULT | DESCRIPTION |
|-------------------------|------------|-------|---------|--|
| CHG_DET_STOP_M | Read/write | [5] | 0 | Charger Detection Run Falling Transition Interrupt Mask 0 = Mask 1 = Not masked |
| RFU | Read/write | [4:3] | 00 | Reserved |
| OVP_M | Read/write | [2] | 0 | Overvoltage Protection Interrupt Mask 0 = Mask 1 = Not masked |
| VB_VALID_M | Read/write | [1] | 0 | V _B Valid Interrupt Mask 0 = Mask 1 = Not masked |
| CHG_TYP_M | Read/write | [0] | 0 | Charge Type Interrupt Mask 0 = Mask 1 = Not masked |
| INTMASK 2 (0x06) | | | | |
| ADC_ERROR_M | Read/write | [7] | 0 | ADC Error Interrupt Mask 0 = Mask 1 = Not masked |
| RFU | Read/write | [6:1] | 000000 | Reserved |
| ADC_M | Read/write | [0] | 0 | ADC Change Interrupt Mask 0 = Mask 1 = Not masked |
| CONTROL 1 (0x07) | | | | |
| INT_TYP | Read/write | [7] | 0 | This bit sets the interrupt type. See the <i>Interrupts</i> section for details. 0 = Interrupt is level triggered 1 = Interrupt is edge triggered |
| INT_DLY | Read/write | [6] | 0 | This bit sets the interrupt pulse width in case of trains of interrupt requests. This bit is valid only if INT_TYP = 1. 0 = 2 x 60kHz clock ticks 1 = 4 x 60kHz clock ticks |
| INT_POL | Read/write | [5] | 0 | This bit sets the interrupt polarity. See the <i>Interrupts</i> section for details. 0 = Active low 1 = Active high |
| INT_EN | Read/write | [4] | 0 | This bit enables interrupt generation. When INT_EN = 0, pending interrupts are not cleared and the $\overline{\text{INT}}$ pin acts as a $\overline{\text{FLAG}}$ per Table 4. INT_EN is a global setting to mask all interrupts. 0 = Disable interrupt 1 = Enable interrupt |

Table 2. Detailed Register Map (continued)

| FIELD NAME | READ/WRITE | BITS | DEFAULT | DESCRIPTION |
|-------------------------|------------|-------|---------|---|
| USB_SWC | Read/write | [3:2] | 11 | USB Switch Control 00 = All switches open 01 = USB switches connected to UT/UR position 10 = USB switches connected to TD+/TD- position 11 = Follow the detection finite state machine |
| CP_EN | Read/write | [1] | 0 | Charge Pump Enable. To pass a negative signal to UR/UT, this bit must be set high. 0 = Charge pump disabled 1 = Charge pump enabled |
| LOW_PWR | Read/write | [0] | 1 | Low-Power Mode Enable 0 = Low-power mode disable. The oscillator and bandgap are always on. 1 = Low-power mode enable. The oscillator and bandgap are turned off when V_{BUS} is not valid, USB_SWC = 00, CP_EN = 0, and ADC_S = 11111. |
| CONTROL 2 (0x08) | | | | |
| APPL_NXT | Read/write | [7] | 1 | Enable Next Possible Apple Charger (CHG_TYP = 1100) 0 = CHG_TYP = 1100 cannot be detected 1 = CHG_TYP = 1100 can be detected |
| CE_FRC | Read/write | [6] | 0 | Enable Force \overline{CE} Outputs 0 = \overline{CE} output follow the charger detection finite state machine as per Table 3 1 = \overline{CE} output forced as per CE bit configuration |
| CE | Read/write | [5] | 0 | \overline{CE} Output Forced Value. Valid only with CE_FRC = 1. 1 = \overline{CE} output forced low 0 = \overline{CE} output forced high impedance |
| ADC_DEB | Read/write | [4:3] | 01 | These bits set the ADC debounce time setting. 00 = 0.5ms (typ) 01 = 10ms (typ) 10 = 25ms (typ) 11 = 38.6ms (typ) |
| USB_CPL | Read/write | [2] | 1 | USB Compliant Bit 0 = Device is not USB compliant 1 = Device is USB compliant |
| ID_AUTO_SWC | Read/write | [1] | 1 | ID Auto Switch Control. ID resistor change during valid V_B enables the auto switch configuration based on Table 3. 0 = No auto switch configuration after the first auto configuration from initial valid V_B 1 = Allow auto switch configuration based on ID while V_B is valid |

Table 2. Detailed Register Map (continued)

| FIELD NAME | READ/WRITE | BITS | DEFAULT | DESCRIPTION |
|-------------------------|------------|-------|---------|---|
| ADC_EN | Read/write | [0] | 0 | ADC Enable. When ADC_EN is set low, the ADC is automatically enabled when valid V_B is present and disabled when V_B becomes invalid. When ADC_EN is set high, the ADC is always enabled regardless of V_B . The device draws more quiescent current when ADC_EN is set high. 0 = ADC disable with battery power only, and active only with valid V_B 1 = ADC always active |
| CONTROL 3 (0x09) | | | | |
| OVP_EN | Read/write | [7:6] | 10 | Manual Overvoltage Protection Control 00 = Force OVP open 01 = Force OVP closed $V_B > V_{VBDET}$ 10 = OVP controlled by logic (closed after V_{BUS} attach based on Table 4) 11 = Reserved for future use |
| CDP_DET | Read/write | [5] | 0 | USB Charger Downstream Detection Method 0 = Use V_{DP_SRC} to drive D- 1 = Use weak pullup method |
| DCHK_TM | Read/write | [4] | 0 | Charger Type Detection Timer 0 = $t_{DP_SRC_ON}$ is set to 50ms 1 = $t_{DP_SRC_ON}$ is set to 620ms |
| DCD_2S_CT | Read/write | [3] | 1 | Data Contact Detection Exit Method 0 = Stay in DCD until normal exit 1 = Exit DCD when 2s (typ) interrupt asserts |
| DCD_EN | Read/write | [2] | 1 | Data Contact Detection State Machine Enable. If DCD is enabled, then before D+/D- is tested for a short, DCD must pass. If DCD is disabled, the DCD is skipped and D+/D-short detection begins. If DCD state machine is running for more than 2s (typ), the DCD timer interrupt is set high (DCD_TMR = 1). 0 = Disable 1 = Enable |
| CHG_TYP_MAN | Read/write | [1] | 0 | Charger Type Manual Detection. This bit forces the internal logic to open the USB switches and perform charger type detection when set high. After the detection state machine completes, this bit self-resets. 0 = Disabled 1 = Enable charger detection |
| CHG_DET_EN | Read/write | [0] | 1 | USB Charger Detection Enable 0 = Disable charger detection 1 = Enable charger detection |

Detailed Description

The MAX14646E is a USB charger detector that includes features from USB Battery Charging Specification Revision 1.2. The IC features internal detection logic for determining the device connected and is controlled through the I2C interface. The device is a complete solution for multiplexing a USB and UART signal on a single USB connector with a Li+ battery charger.

USB Charger Detection

The IC includes internal logic to detect if a valid USB charger is connected. When a valid V_{BUS} voltage is

applied to V_B or when CHG_TYP_MAN in the CONTROL 3 (0x09) register is set to 1, the device begins the charger type detection sequence. During the charger type detection sequence, the CD- and CD+ switches are open, and when the sequence completes, the switches return to their previous state. When the IC detects the charger, it sets the CE output based on the charger found (Table 3). Figure 1 shows a timing diagram for an example charger type detection sequence. Figure 2 shows D+/D- termination for a standard USB host charging downstream port, Apple charger, Sony charger, and a dedicated charger.

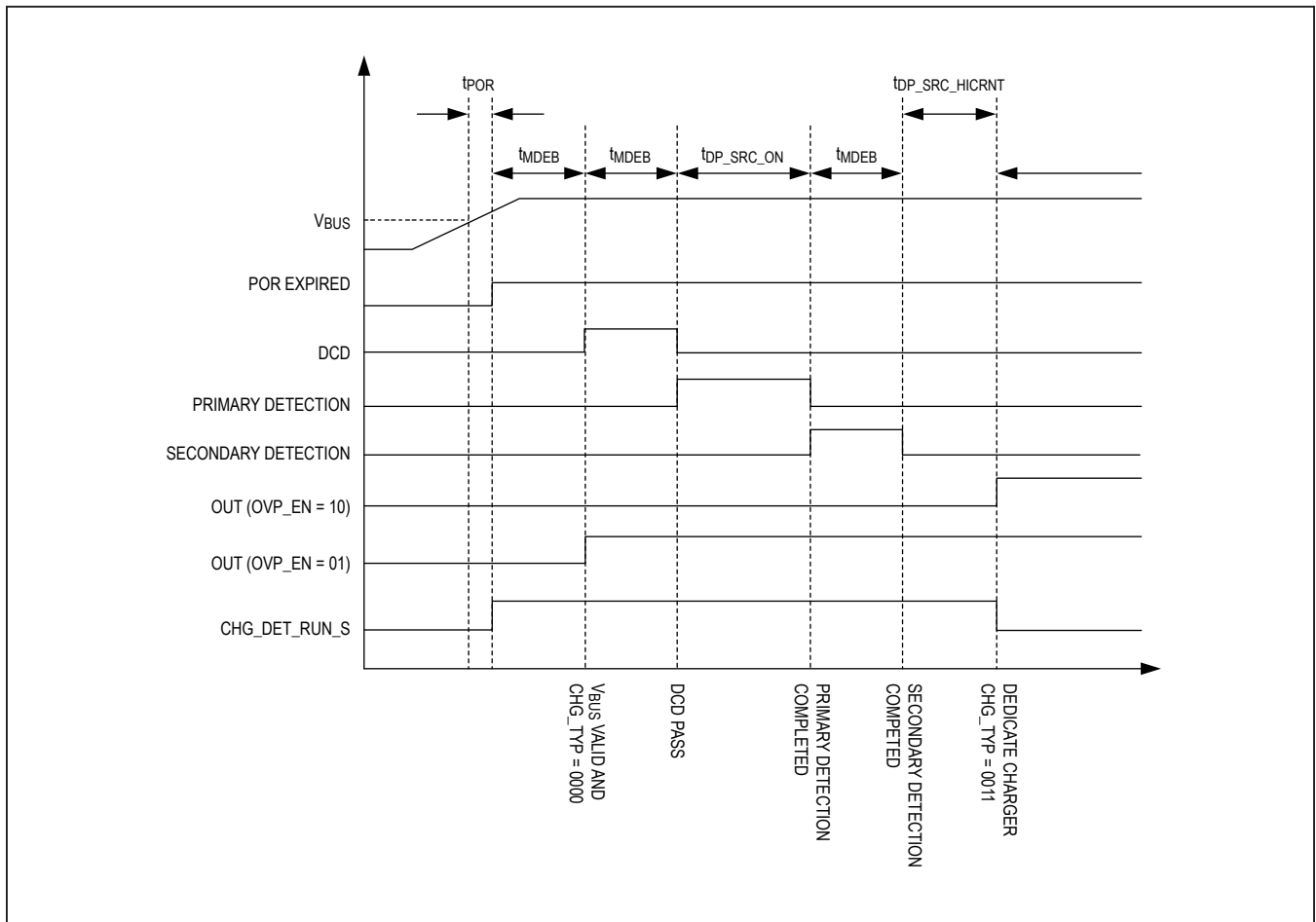

Figure 1. Charger Detection Timing

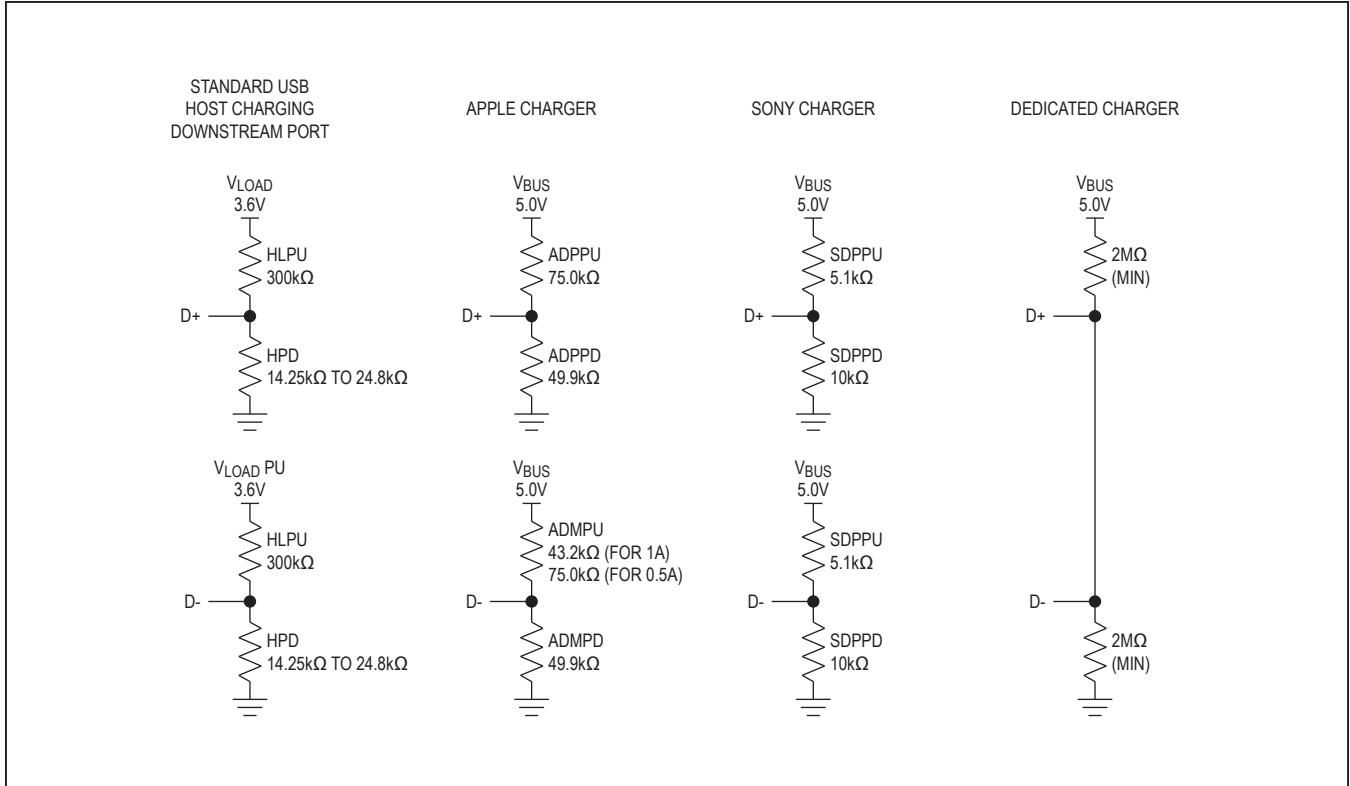

Figure 2. Standard USB Host Charging Downstream Port, Apple Charger, Sony Charger, and Dedicated Charger

Table 3. Charger Control Output Status

| CHG_TYP | CHARGER DETECTED | CE OUTPUT | |
|---------|--------------------------|-------------|-------------|
| | | USB_CPL = 0 | USB_CPL = 1 |
| 0000 | Off | 1 | 1 |
| 0001 | Standard downstream port | 0 | 1 |
| 0010 | Charging downstream port | 0 | 0 |
| 0011 | Dedicated charger port | 0 | 0 |
| 0100 | Apple 0.5A (max) charger | 0 | 0 |
| 0101 | Apple 1A (max) charger | 0 | 0 |
| 0110 | Apple 2A (max) charger | 0 | 0 |
| 0111 | Special 500mA charger | 0 | 0 |
| 1100 | Reserved | 0 | 0 |

Detection Debounce

To avoid multiple interrupts at the insertion of an accessory and for added noise/disturbance protection, a debounce timer 30ms (typ) is present that requires an inserted or removed state hold for the debounce time before it sends an interrupt.

USB Switch (CD+, CD-)

The device supports Hi-Speed, full-speed, and low-speed USB signal levels. The USB channel is bidirectional and has low 3Ω (typ) on-resistance and 7pF (typ) on-capacitance. The low on-resistance is stable as the analog input signals are swept from ground to V_{SWPOS} for low signal distortion. This channel can pass negative audio signal without distortion when $CP_EN = 1$.

USB Switch (UT, UR)

The IC supports standard single-supply UART signals. The UART channel supports high-speed signals. The UART channel is bidirectional and has low 2.4Ω (typ) on-resistance. This channel can pass negative audio signal without distortion when $CP_EN = 1$.

Overvoltage Protection

The IC features overvoltage protection up to +36V (max) on the V_{BUS} line. If the input voltage exceeds the overvoltage lockout cutoff threshold (V_{OVLO}), the internal FET with low 60mΩ (typ) on-resistance disconnects the input from the output and protects low-voltage systems against voltage faults. The device features soft-start capability to minimize inrush current by slowly turning the internal FET on when the V_B voltage is valid for a period longer than the debounce time (t_{MDEB}). When the overvoltage event occurs, the fault flag or interrupt is asserted depending on the INT_EN configuration in the CONTROL 1 (0x07) register.

Thermal Shutdown

The IC features thermal shutdown protection to protect the device from fault conditions. When the die temperature is +150°C, the device enters thermal shutdown mode and the fault flag or interrupt is asserted depending on INT_EN configuration in the CONTROL 1 (0x07) register. When the die temperature drops by 20°C, the device automatically resumes operation and the fault flag or interrupt is cleared.

Supply Voltage Selector

The supply voltage selector chooses between V_B and BAT inputs to power the internal blocks. If V_B is not present, V_{CCINT} is supplied from BAT. A typical 100μs POR is provided at the rising edge of V_{CCINT} .

Interrupts

The MAX14646E generates an interrupt for any change in VB_VALID_S , when DCD_TMR_S transitions from 0 to 1, and when an overvoltage and thermal shutdown events occur. The INT_EN bit in the CONTROL 1 register (0x07) enables interrupt output. When INT_EN sets to disable, all interrupts are masked, but not cleared. A read to the INTERRUPT 1 register (0x01) and INTERRUPT 2 register (0x02) is required to clear the interrupts. The \overline{INT} pin is defaulted as a \overline{FLAG} function when the interrupt is disabled ($INT_EN = 0$). The \overline{INT} pin is pulled low when an invalid or an unknown charger is inserted.

Level-Triggered Interrupt

Set the INT_TYP bit in the CONTROL 1 (0x07) register low to select a level-triggered interrupt. Any unmasked interrupt event drives the \overline{INT} line to its active level, and then holds it at that level until the interrupt register is read or cleared. Set the INT_POL bit in the CONTROL 1 (0x07) register to configure the active level of the \overline{INT} line. Since multiple events share a level-triggered interrupt line, upon detecting assertion of the interrupt line, the host must read the entire interrupt registers. After servicing the interrupt, the host rechecks the interrupt line status to determine if an interrupt is pending.

Edge-Triggered Interrupt

Set the INT_TYP bit in the CONTROL 1 (0x07) register high to select an edge-triggered interrupt. Any unmasked interrupt event toggles the \overline{INT} line to its active level with a pulse width set by the INT_DLY bit in the CONTROL 1 (0x07) register. Set the INT_POL bit in the CONTROL 1 (0x07) register to configure the active level of the \overline{INT} line. If another interrupt occurs before the toggle is not over, the new interrupt event extends the toggle time by the period set by the INT_DLY bit in the CONTROL 1 (0x07) register.

Low-Power Modes

The IC has CP_EN and LOW_PWR bits in the CONTROL 1 register (0x07) dedicated to low-power operation. CP_EN controls the charge pump required for proper operation of the analog switches. When set to disable, no negative rail voltage can be applied.

The LOW_PWR bit sets low-power mode. In low-power mode, the internal oscillator is turned off under the following conditions: no V_{BUS} , $USB_SWC = 00$, $CP_EN = 0$, and $ADC_S = 1111$. When low-power mode is enabled, all switches are high impedance. Note that no negative rail voltage can be applied.

When low-power mode is disabled, the oscillator and bandgap are always on. If V_{BUS} is not present, the low-power mode can be disabled, the switches can be closed, and the battery power mode can be enabled using I²C commands.

Digital Inputs

The digital inputs must be designed to be compatible with 1.8V logic.

Digital Outputs

The digital outputs are open drain with the exception of IDBF. The IDBF pin has three possible states: GND, high impedance, and an output based on the ID resistor value. [Table 4](#) shows the output status with different ID resistor settings.

Micro-USB ID Input

The resistor to GND at the ID pin of the USB connector determines the factory operating mode as defined in [Table 3](#) and [Electrical Characteristics](#) table.

I²C Serial Interface

Serial Addressing

The IC operates as a slave device that sends and receives data through an I²C-compatible 2-wire interface. The interface uses a serial-data line (SDA) and a serial-clock line (SCL) to achieve bidirectional communication between master(s) and slave(s). A master (typically a microcontroller) initiates all data transfers to and from the IC and generates the SCL clock that synchronizes the data transfer. The SDA line operates as both an input and an open-drain output. A pullup resistor is required on SDA. The SCL line operates only as an input. A pullup resistor is required on SCL if there are multiple masters on the 2-wire interface, or if the master in a single-master system has an open-drain SCL output. Each transmission consists of a START (S) condition ([Figure 4](#)) sent by a master, followed by the MAX14646E 7-bit slave address plus R/W bit, a register address byte, one or more data bytes, and finally a STOP (P) condition.

Table 4. Output Status*

| STATUS | | | | | | | | | |
|------------------|--------|------------------|-----------------|--------------|-----------------|------------------|--------------------|-----------------|-----------------|
| MAX14646E | RESET | INVALID | OTG | UART | USB/ FACTORY | UART/ FACTORY | UNKNOWN CHARGER | CHARGER | USB DEVICE |
| V_B | 0V | Not Connected | Connected | Connected | Connected | Connected | Connected | Connected | Connected |
| ID | — | — | < 1.5k Ω | 30k Ω | 45k Ω | 150k Ω | Undefined | > 750k Ω | > 750k Ω |
| CD+ | — | — | TD+ | UR | TD+ | UR | TD+ | TD+ | TD+ |
| CD- | — | — | TD- | UT | TD- | UT | TD- | TD- | TD- |
| OUT | High-Z | High-Z | V_B | High-Z | V_B | V_B | V_B | V_B | V_B |
| \overline{CE} | High-Z | High-Z | High-Z | High-Z | Low | Low | High-Z | Low | High-Z |
| IDBF | High-Z | High-Z | GND | High-Z | V_{BUS} | V_{BUS} | High-Z | High-Z | High-Z |
| UR | High-Z | High-Z | High-Z | CD+ | High-Z | CD+ | High-Z | High-Z | High-Z |
| UT | High-Z | High-Z | High-Z | CD- | High-Z | CD- | High-Z | High-Z | High-Z |
| TD+ | High-Z | High-Z | CD+ | High-Z | CD+ | High-Z | CD+ | CD+ | CD+ |
| TD- | High-Z | High-Z | CD- | High-Z | CD- | High-Z | CD- | CD- | CD- |
| \overline{INT} | High-Z | Low | High-Z | High-Z | High-Z | High-Z | Low | High-Z | High-Z |

*Table 4 is true when the I²C registers are set at default.

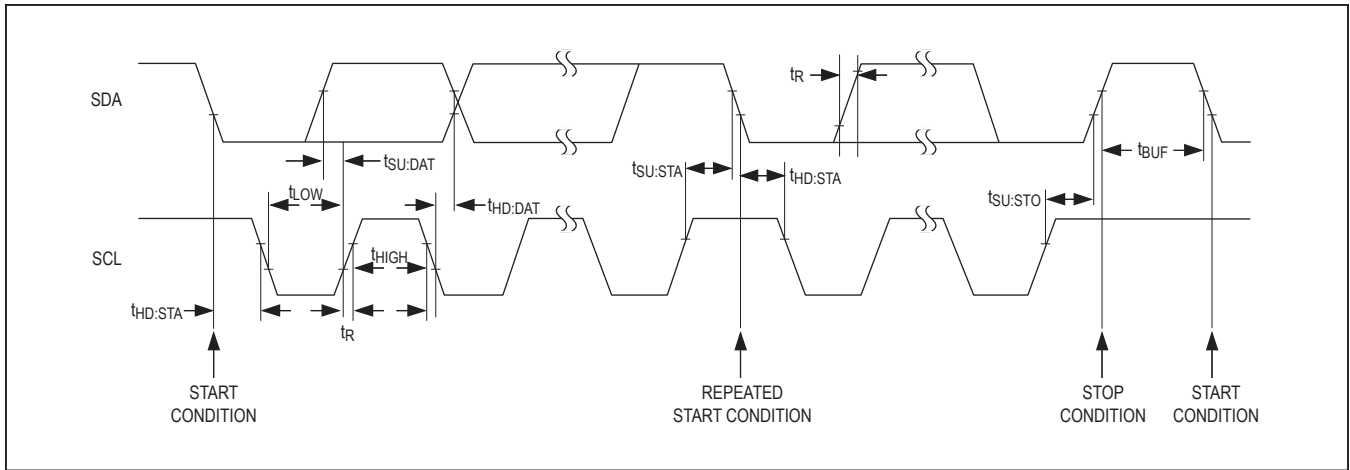

Figure 3. I²C Interface Timing

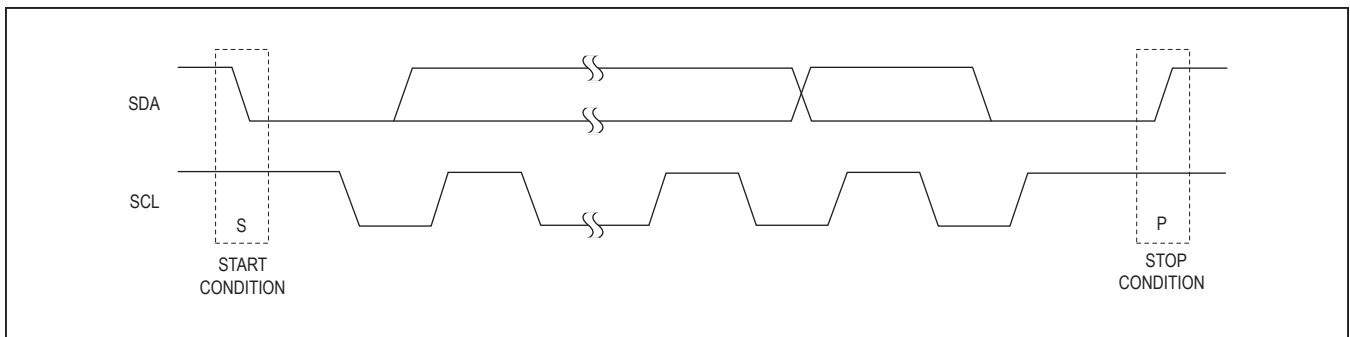

Figure 4. START and STOP Conditions

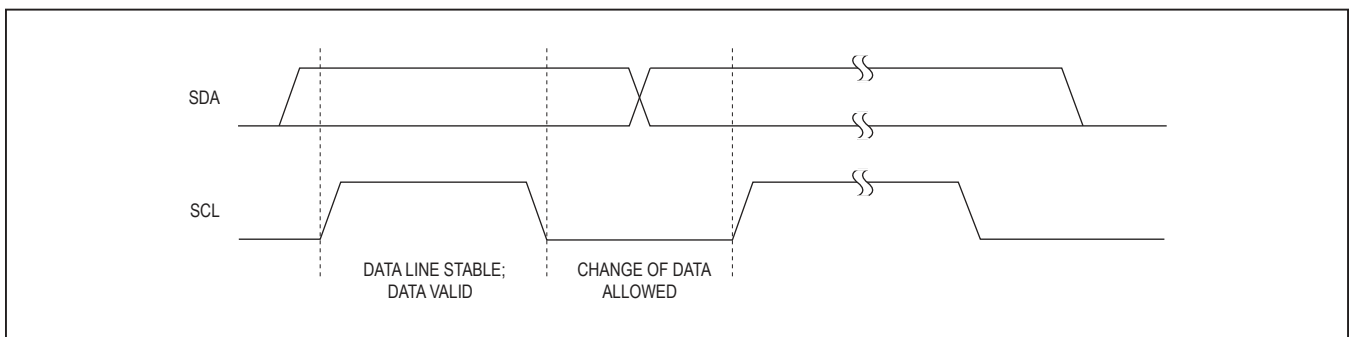

Figure 5. Bit Transfer

START and STOP Conditions

Both SCL and SDA remain high when the interface is not busy. A master signals the beginning of a transmission with a START condition by transitioning SDA from high to low while SCL is high (Figure 4.) When the master has finished communicating with the slave, it issues a STOP

condition by transitioning SDA from low to high while SCL is high. The bus is then free for another transmission.

Bit Transfer

One data bit is transferred during each clock pulse (Figure 5). The data on SDA must remain stable while SCL is high.

Acknowledge

The acknowledge bit is a clocked 9th bit (Figure 6) that the recipient uses to handshake receipt of each byte of data. Thus, each byte transferred effectively requires 9 bits. The master generates the 9th clock pulse, and the recipient pulls down SDA during the acknowledge clock pulse. The SDA line is stable low during the high period of the clock pulse. When the master is transmitting to the IC, the IC generates the acknowledge bit because the IC is the recipient. When the IC is transmitting to the master, the master generates the acknowledge bit because the master is the recipient.

Slave Address

The IC has a 7-bit long slave address (0110101b). The bit following a 7-bit slave address is the R/W bit, which is low for a write command and high for a read command. The slave address is 01101011 for read commands and 01101010 for write commands (Figure 7).

Bus Reset

The IC resets the bus with the I²C START condition for reads. When the R/W bit is set to 1, the IC transmits data to the master, thus the master is reading from the devices.

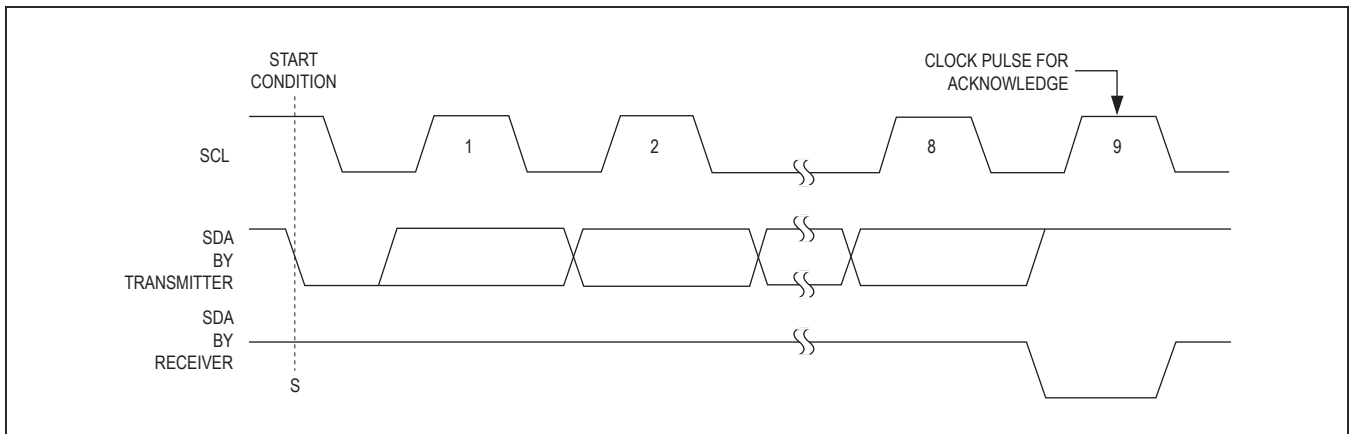

Figure 6. Acknowledge

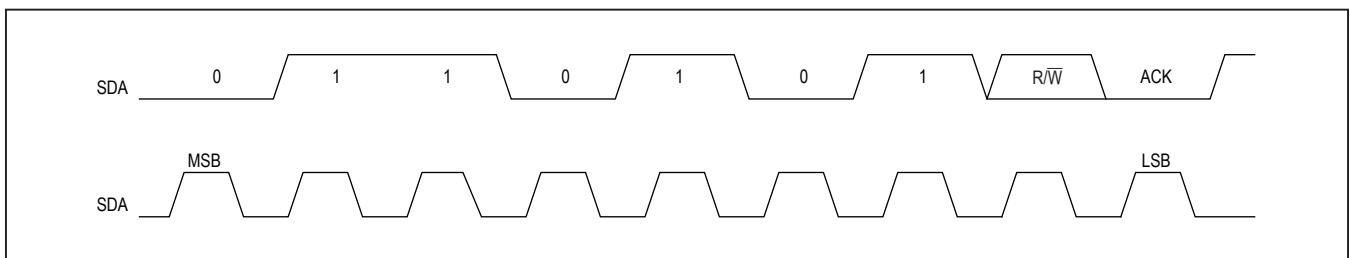

Figure 7. Slave Address

Format for Writing

A write to the IC comprises the transmission of the slave address with the R/W bit set to 0, followed by at least 1 byte of information. The first byte of information is the register address or command byte. The register address determines which register of the IC is to be written by the next byte, if received. If a STOP (P) condition is detected after the register address is received, the IC takes no

further action beyond storing the register address (Figure 8). Any bytes received after the register address are data bytes. The first data byte goes into the register selected by the register address and subsequent data bytes go into subsequent registers (Figure 9). If multiple data bytes are transmitted before a STOP condition, these bytes are stored in subsequent registers because the register addresses autoincrement.

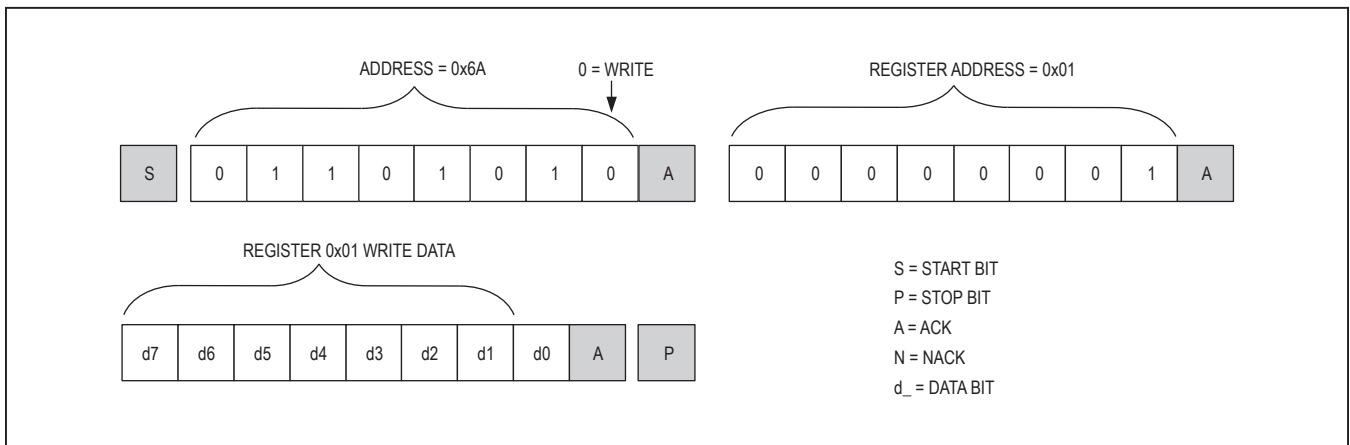

Figure 8. Format for I²C Write



Figure 9. Format for Writing to Multiple Registers

Format for Reading

The IC is read using the internally stored register address as an address pointer, the same way the stored register address is used as an address pointer for a write. The pointer autoincrements after each data byte is read using the same rules as for a write. Thus, a read is initiated by first configuring the register address by performing a write (Figure 10). The master can now read consecutive bytes from the IC, with the first data byte being read from the register address pointed to by the previously written register address. Once the master sends a NACK, the IC stops sending valid data.

Applications Information

Hi-Speed USB

Hi-Speed USB requires careful PCB layout with 45Ω single-ended/90Ω differential controlled-impedance matched traces of equal lengths.

Power-Supply Bypassing

Bypass V_B and BAT with 1μF ceramic capacitors to GND as close as possible to the device.

Power-On Reset (POR)

The IC provides secure operation with the power-on-reset circuits. When the power supply for the device exceeds the POR rising value 1.6V (typ) and stays above the maximum falling edge, the internal logic is in a known state for safe operation. However, the *Electrical Characteristics* table parameters are not guaranteed until the V_B and BAT voltages meet the specified global conditions.

Choosing I²C Pullup Resistors

I²C requires pullup resistors to provide a logic-high level to data and clock lines. There are trade-offs between power dissipation and speed, and a compromise must be made in choosing pullup resistor values. Every device connected to the bus introduces some capacitance even when the IC is not in operation. I²C specifies 300ns rise time to go from low to high (30% to 70%) for fast mode, which is defined for a clock frequency up to 400kHz. See the I²C specifications in the *Electrical Characteristics* table for details.

To meet the rise time requirement, choose pullup resistors so that the rise time $t_R = 0.85 \times R_{PULLUP} \times C_{BUS} < 300ns$. If the transition time becomes too slow, the setup and hold times might not be met and waveforms might not be recognized.

Resetting I²C from Suspend

If the I²C bus is suspended due to weak or dead battery, an I²C STOP command needs to be performed after enabling the I²C buffers and pullup bias. The I²C STOP command is necessary before restarting the I²C traffic.

Extended ESD Protection

ESD-protection structures are incorporated on all pins to protect against electrostatic discharges up to ±2kV (HBM) encountered during handling and assembly. The CD-, CD+, and ID pins are further protected against ESD up to ±15kV (HBM) without damage. The V_B input withstands up to ±15kV (HBM) if bypassed with a 1μF ceramic capacitor close to the pin. The ESD structures withstand high ESD both in normal operation and when the device is powered down. After an ESD event, the IC continues to function without latchup.

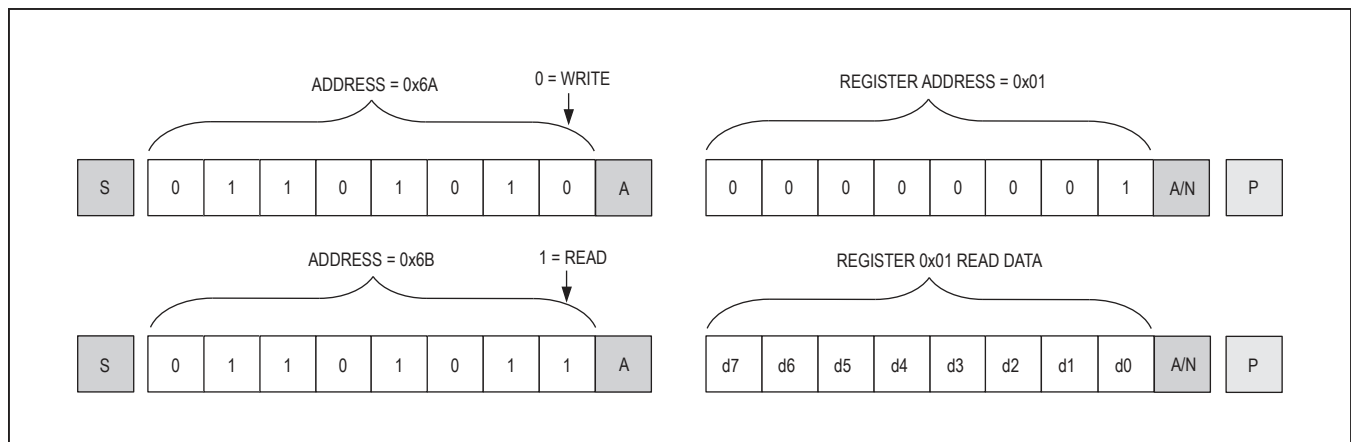

Figure 10. Format for Reads (Repeated START)

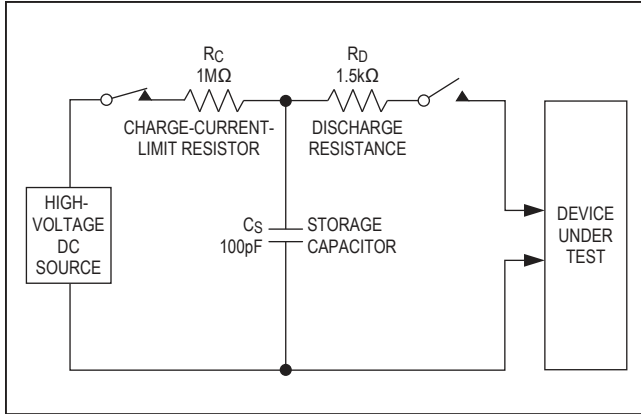

Figure 11. Human Body ESD Test Model

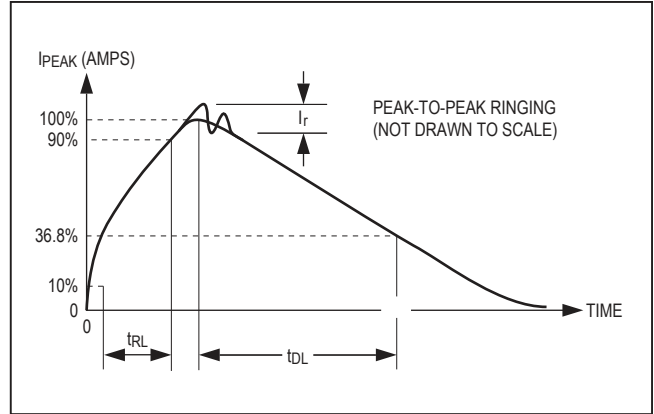

Figure 12. Human Body Current Waveform

ESD Test Conditions

ESD performance depends on a variety of conditions. Contact Maxim for a reliability report that documents test setup, test methodology, and test results.

Human Body Model

Figure 11 shows the Human Body Model, and Figure 12 shows the current waveform it generates when discharged into a low-impedance state. This model consists of a 100pF capacitor charged to the ESD voltage of interest that is then discharged into the IC through a 1.5kΩ resistor.

Ordering Information

| PART | TEMP RANGE | PIN-PACKAGE |
|----------------|----------------|-------------|
| MAX14646EEWE+T | -40°C to +85°C | 16 WLP |

+Denotes a lead(Pb)-free/RoHS-compliant package.
T = Tape and reel.

Package Information

For the latest package outline information and land patterns (footprints), go to www.maximintegrated.com/packages. Note that a “+”, “#”, or “-” in the package code indicates RoHS status only. Package drawings may show a different suffix character, but the drawing pertains to the package regardless of RoHS status.

| PACKAGE TYPE | PACKAGE CODE | OUTLINE NO. | LAND PATTERN NO. |
|--------------|--------------|-------------------------|--|
| 16 WLP | W161C1+1 | 21-0491 | Refer to Application Note 1891 |

Typical Operating Circuit

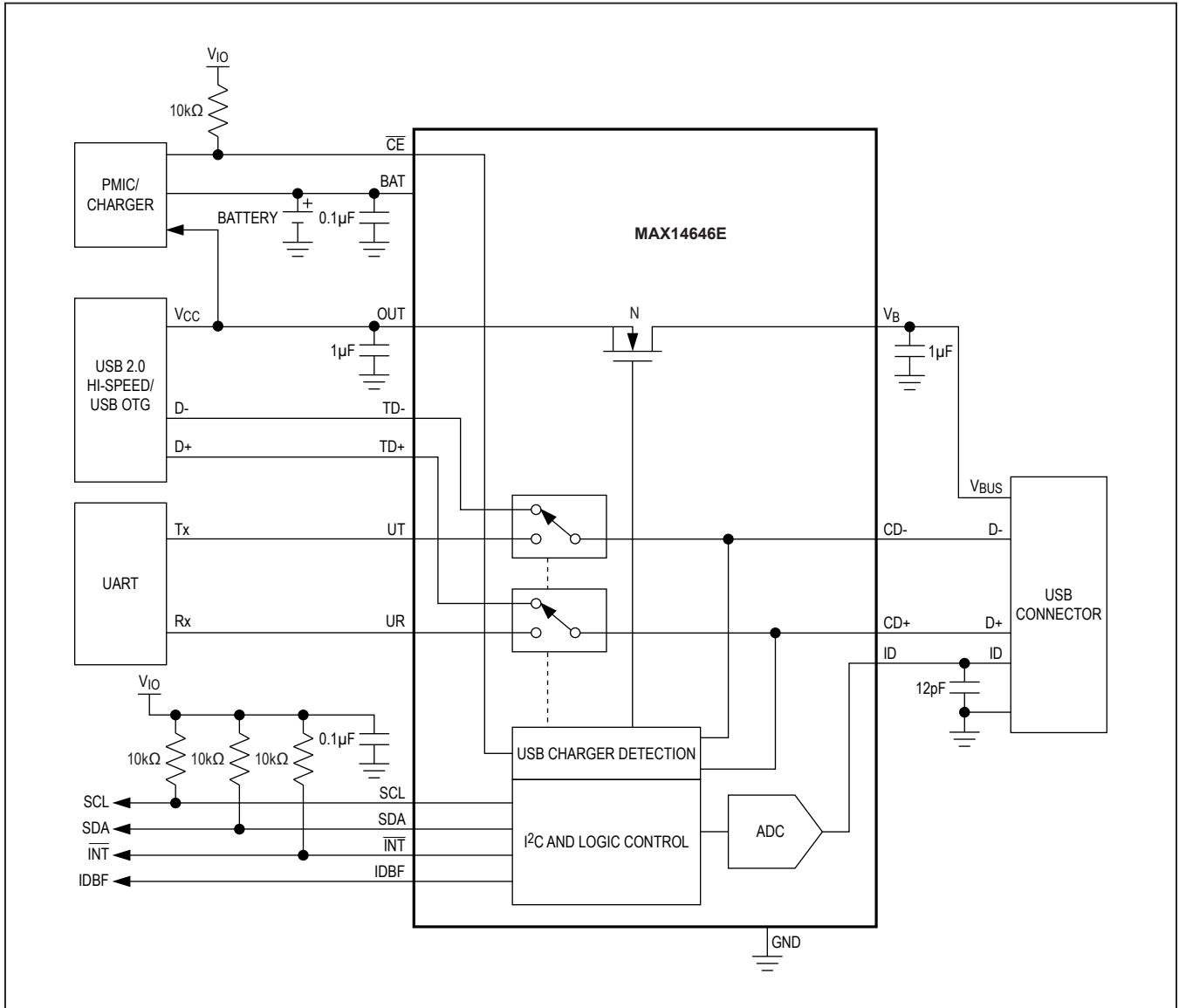

Revision History

| REVISION NUMBER | REVISION DATE | DESCRIPTION | PAGES CHANGED |
|-----------------|---------------|-----------------|---------------|
| 0 | 5/12 | Initial release | — |

For pricing, delivery, and ordering information, please contact Maxim Direct at 1-888-629-4642, or visit Maxim Integrated's website at www.maximintegrated.com.

Maxim Integrated cannot assume responsibility for use of any circuitry other than circuitry entirely embodied in a Maxim Integrated product. No circuit patent licenses are implied. Maxim Integrated reserves the right to change the circuitry and specifications without notice at any time. The parametric values (min and max limits) shown in the Electrical Characteristics table are guaranteed. Other parametric values quoted in this data sheet are provided for guidance.