

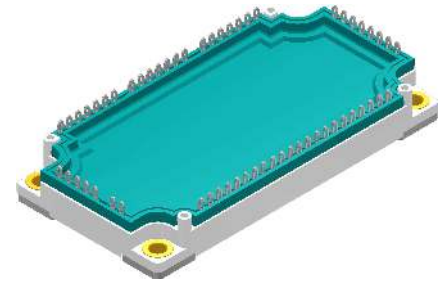
Standard Rectifier Module

| |
|---------------------------|
| 3~ Rectifier |
| $V_{RRM} = 1600\text{ V}$ |
| $I_{DAV} = 900\text{ A}$ |
| $I_{FSM} = 8000\text{ A}$ |


3~ Rectifier Bridge + NTC

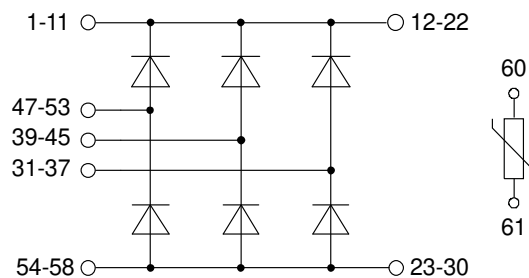
Part number

MDMA900U1600PTEH



Backside: isolated

 E72873



Features / Advantages:

- Package with DCB ceramic
- Improved temperature and power cycling
- Planar passivated chips
- Very low forward voltage drop
- Very low leakage current

Applications:

- Diode for main rectification
- For three phase bridge configurations
- Supplies for DC power equipment
- Input rectifiers for PWM inverter
- Battery DC power supplies
- Field supply for DC motors

Package: E3-Pack

- Isolation Voltage: 3600 V~
- Industry standard outline
- RoHS compliant
- PressFit-Pins for PCB mounting
- Height: 17 mm
- Base plate: Copper internally DCB isolated
- Advanced power cycling
- Phase Change Material available

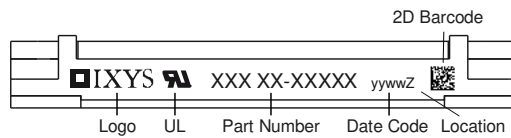
Disclaimer Notice

Information furnished is believed to be accurate and reliable. However, users should independently evaluate the suitability of and test each product selected for their own applications. Littelfuse products are not designed for, and may not be used in, all applications. Read complete Disclaimer Notice at www.littelfuse.com/disclaimer-electronics.



| Rectifier | | | | Ratings | | | |
|------------|--|-----------------------------------|-------------------|------------------------------|------|-------|-------------------|
| Symbol | Definition | Conditions | | min. | typ. | max. | Unit |
| V_{RSM} | max. non-repetitive reverse blocking voltage | | | | | 1700 | V |
| V_{RRM} | max. repetitive reverse blocking voltage | | | | | 1600 | V |
| I_R | reverse current | $V_R = 1600$ V | | $T_{VJ} = 25^\circ\text{C}$ | | 200 | μA |
| | | $V_R = 1600$ V | | $T_{VJ} = 150^\circ\text{C}$ | | 5 | mA |
| V_F | forward voltage drop | $I_F = 300$ A | | $T_{VJ} = 25^\circ\text{C}$ | | 1.27 | V |
| | | $I_F = 900$ A | | | | 1.92 | V |
| | | $I_F = 300$ A | | $T_{VJ} = 125^\circ\text{C}$ | | 1.19 | V |
| | | $I_F = 900$ A | | | | 1.94 | V |
| I_{DAV} | bridge output current | $T_C = 85^\circ\text{C}$ | rectangular | $T_{VJ} = 150^\circ\text{C}$ | | 900 | A |
| | | | $d = \frac{1}{3}$ | | | | |
| V_{FO} | threshold voltage | } for power loss calculation only | | $T_{VJ} = 150^\circ\text{C}$ | | 0.78 | V |
| r_F | slope resistance | | | | | 1.3 | m Ω |
| R_{thJC} | thermal resistance junction to case | | | | | 0.1 | K/W |
| R_{thCH} | thermal resistance case to heatsink | | | | 0.05 | | K/W |
| P_{tot} | total power dissipation | | | $T_C = 25^\circ\text{C}$ | | 1250 | W |
| I_{FSM} | max. forward surge current | $t = 10$ ms; (50 Hz), sine | | $T_{VJ} = 45^\circ\text{C}$ | | 8.00 | kA |
| | | $t = 8,3$ ms; (60 Hz), sine | | $V_R = 0$ V | | 8.64 | kA |
| | | $t = 10$ ms; (50 Hz), sine | | $T_{VJ} = 150^\circ\text{C}$ | | 6.80 | kA |
| | | $t = 8,3$ ms; (60 Hz), sine | | $V_R = 0$ V | | 7.35 | kA |
| I^2t | value for fusing | $t = 10$ ms; (50 Hz), sine | | $T_{VJ} = 45^\circ\text{C}$ | | 320.0 | kA ² s |
| | | $t = 8,3$ ms; (60 Hz), sine | | $V_R = 0$ V | | 310.5 | kA ² s |
| | | $t = 10$ ms; (50 Hz), sine | | $T_{VJ} = 150^\circ\text{C}$ | | 231.2 | kA ² s |
| | | $t = 8,3$ ms; (60 Hz), sine | | $V_R = 0$ V | | 224.4 | kA ² s |
| C_J | junction capacitance | $V_R = 400$ V; $f = 1$ MHz | | $T_{VJ} = 25^\circ\text{C}$ | | 343 | pF |

| Package E3-Pack | | Ratings | | | | |
|-----------------|--|-------------------------------------|--------------|------|------|--------|
| Symbol | Definition | Conditions | min. | typ. | max. | Unit |
| I_{RMS} | RMS current | per terminal | | | 30 | A |
| T_{VJ} | virtual junction temperature | | -40 | | 150 | °C |
| T_{op} | operation temperature | | -40 | | 125 | °C |
| T_{stg} | storage temperature | | -40 | | 125 | °C |
| Weight | | | | 270 | | g |
| M_D | mounting torque | | 3 | | 6 | Nm |
| $d_{Spp/App}$ | creepage distance on surface / striking distance through air | terminal to terminal | 6.0 | | | mm |
| $d_{Spb/Apb}$ | | terminal to backside | 12.0 | | | mm |
| V_{ISOL} | isolation voltage | t = 1 second t = 1 minute | 3600 3000 | | | V V |
| | | 50/60 Hz, RMS; $I_{ISOL} \leq 1$ mA | | | | |



Part description

M = Module
 D = Diode
 M = Standard Rectifier
 A = (up to 1800V)
 900 = Current Rating [A]
 U = 3- Rectifier Bridge
 1600 = Reverse Voltage [V]
 PT = PressFit-Pin, Thermistor
 EH = E3-Pack
 - = Hyphen
 PC = Phase Change Material

| Ordering | Ordering Number | Marking on Product | Delivery Mode | Quantity | Code No. |
|-------------|---------------------|--------------------|---------------|----------|----------|
| Standard | MDMA900U1600PTEH | MDMA900U1600PTEH | Blister | 24 | 515661 |
| Alternative | MDMA900U1600PTEH-PC | MDMA900U1600PTEH | Blister | 24 | 514468 |

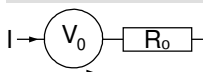
Temperature Sensor NTC

| Symbol | Definition | Conditions | min. | typ. | max. | Unit |
|-------------|-------------------------|---------------------|------|------|------|------------|
| R_{25} | resistance | $T_{VJ} = 25^\circ$ | 4.85 | 5 | 5.15 | k Ω |
| $B_{25/50}$ | temperature coefficient | | | 3375 | | K |

Equivalent Circuits for Simulation

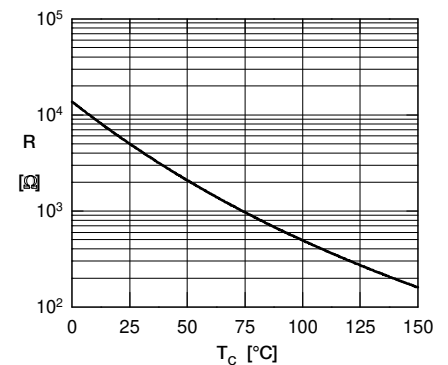
* on die level

$T_{VJ} = 150^\circ\text{C}$



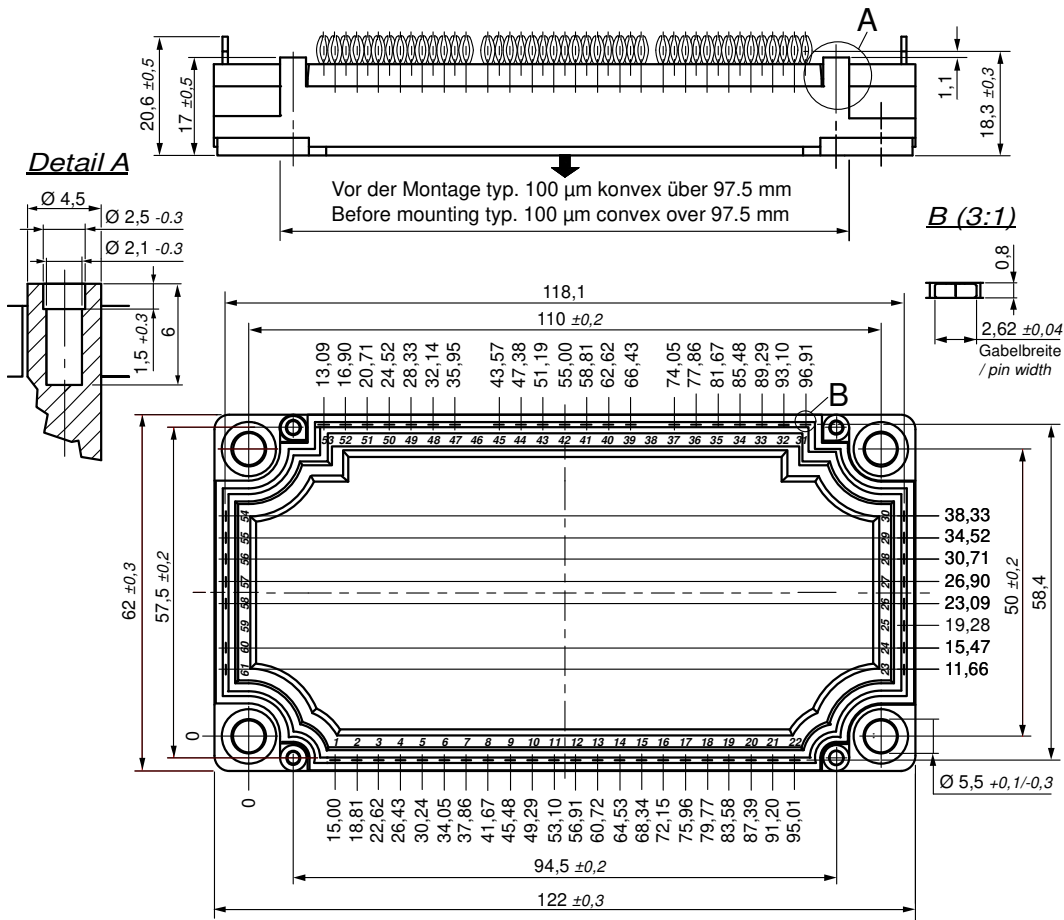
Rectifier

| | | | | | | |
|--------------|--------------------|------|--|--|--|------------|
| $V_{0 \max}$ | threshold voltage | 0.78 | | | | V |
| $R_{0 \max}$ | slope resistance * | 0.36 | | | | m Ω |





Outlines E3-Pack

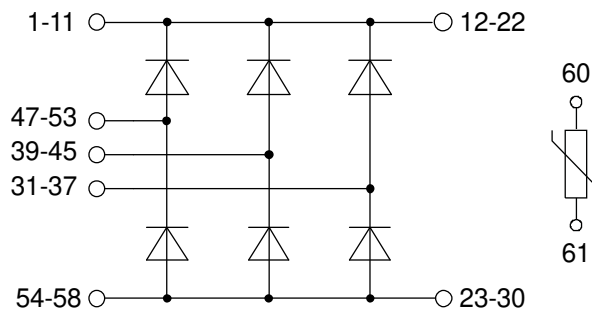


Bemerkung / Note:

- Nichttolerierte Maße nach / Measure without tolerances according DIN ISO 2768-T1-m
- PCB-Lochmuster / PCB hole pattern: **see pin position**
- Toleranz Pin-Position und PCB-Lochmuster / Tolerance of pin position and PCB hole pattern: $\oplus 0.1$
- Bohrlochdurchmesser / Diameter of drill: **Ø 2.35 mm**
- Endlochdurchmesser / Diameter of plated holes: **Ø 2.14 - 2.29 mm** (Cu thickness in via typ. 50 µm)
- Beschichtung / Plating: **chem. Sn max. 15 µm**
- Einpresskraft / Insert Force: per terminal with a typ. insert speed of 7 mm/s: **typ. 90 N**
- Weitere Angaben / Further information: www.ixys.com **Application note IXAN0077**
- Montageanleitung / Mounting instruction: www.ixys.com **Application note IXAN0024**

Detail A: PCB-Montage / Mounting on PCB¹

- Empfohlene, selbstschneidende Schraube / Recommended, self-tapping screw: **EJOT PT®** (Größe / size: **K25**)¹
- Max. Schraubenlänge / Max. screw length: **PCB-Dicke / thickness + 6 mm** (max. Lochtiefe / hole depth)¹
- Empfohlenes Drehmoment / Recommended mounting torque: **1.5 Nm**



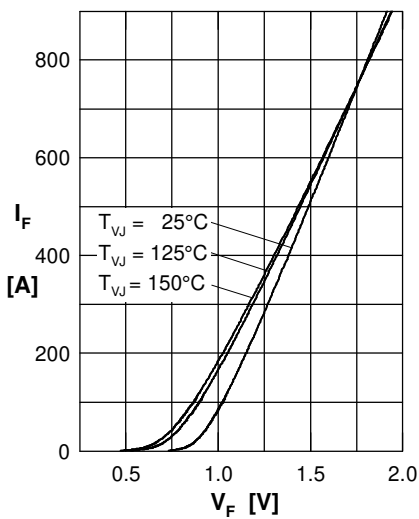
Rectifier


Fig. 1 Forward current versus voltage drop per diode

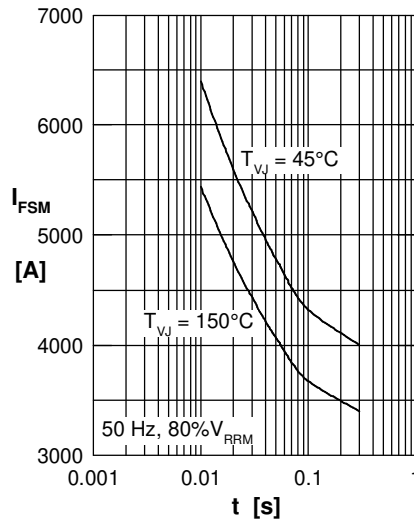


Fig. 2 Surge overload current vs. time per diode

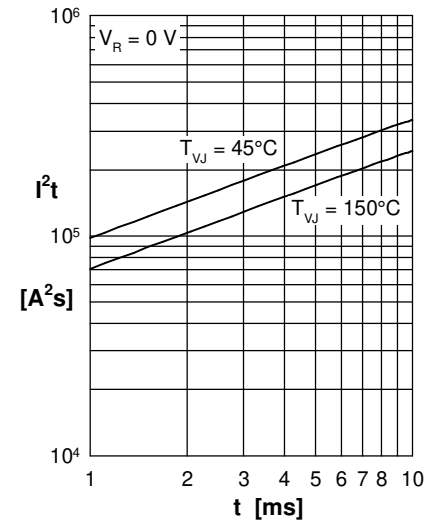
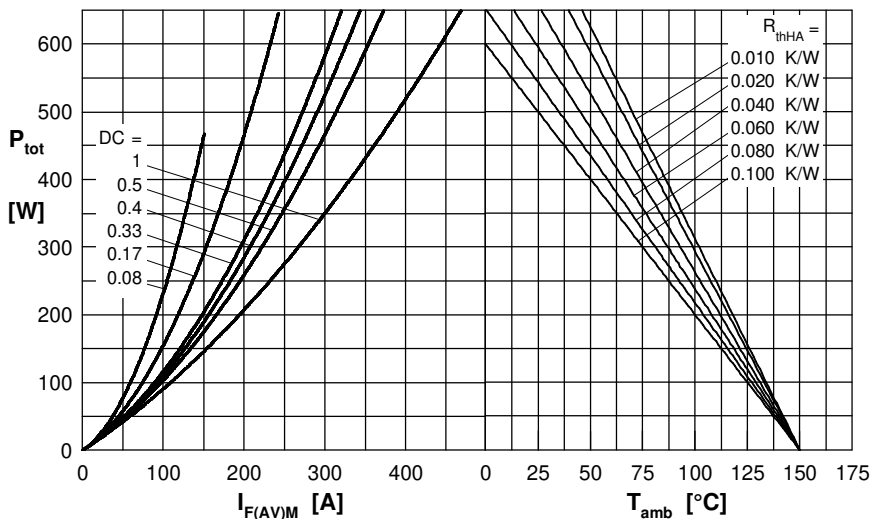

 Fig. 3 I^2t versus time per diode


Fig. 4 Power dissipation vs. forward current and ambient temperature per diode

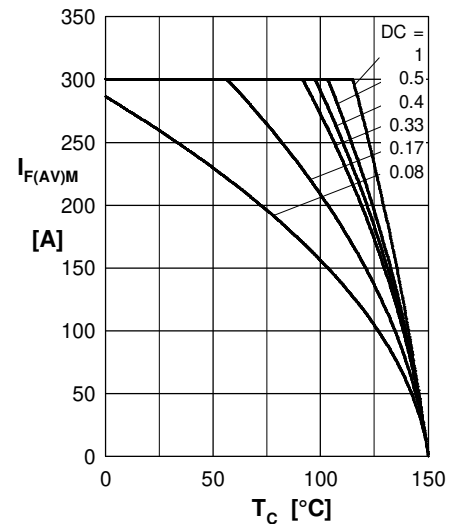


Fig. 5 Max. forward current vs. case temperature per diode

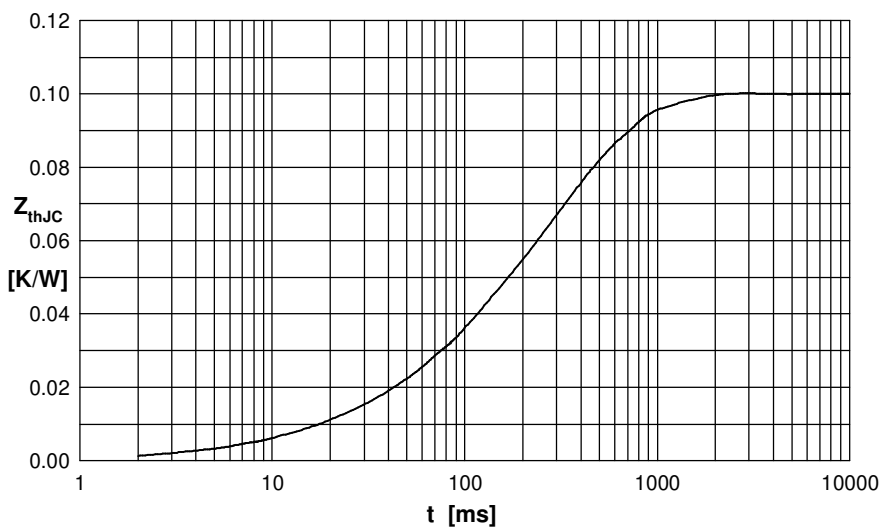


Fig. 6 Transient thermal impedance junction to case vs. time per diode

 Constants for Z_{thJC} calculation:

| i | R_{thi} (K/W) | t_i (s) |
|---|-----------------|-----------|
| 1 | 0.004 | 0.015 |
| 2 | 0.014 | 0.080 |
| 3 | 0.024 | 0.220 |
| 4 | 0.058 | 0.380 |