

TPS563240 17-V, 3-A 1.4-MHz Synchronous Step-Down Voltage Regulator

1 Features

- 3-A converter integrated 70-mΩ and 30-mΩ FETs, support 3.5-A transient
- D-CAP3™ mode control with fast transient response
- Input voltage range: 4.5 V to 17 V
- Output voltage range: 0.6 V to 7 V
- Pulse-skip mode during light load operation without going below 25-kHz switching frequency
- 1.4-MHz switching frequency
- Low shutdown current less than 10 μA
- 1% feedback voltage accuracy (25 °C)
- Startup from pre-biased output voltage
- Cycle-by-cycle overcurrent limit
- Hiccup-mode overcurrent protection
- Non-latch UVP and TSD protections
- Fixed soft start: 1.7 ms

2 Applications

- TV, set-top boxes
- Broadband modem
- Access point networks
- Wireless routers
- Surveillance

3 Description

The TPS563240 is a simple, easy-to-use, 3-A synchronous step-down regulator in SOT-23 package. The peak transient output current can be 3.5 A.

The devices are optimized to operate with minimum external component counts and also optimized to achieve low standby current.

This switching regulator employs D-CAP3 mode control providing a fast transient response and supporting both low-equivalent series resistance (ESR) output capacitors such as specialty polymer and ultra-low ESR ceramic capacitors with no external compensation components.

TPS563240 operates in pulse skip mode, which maintains high efficiency during light load operation. The TPS563240 maintain f_{sw} over 25-kHz under light load condition. The TPS563240 is available in a 6-pin 1.6-mm × 2.9-mm SOT (DDC) package, and specified from a -40°C to 125°C junction temperature.

Device Information⁽¹⁾

| PART NUMBER | PACKAGE | BODY SIZE (NOM) |
|-------------|---------|-------------------|
| TPS563240 | DDC (6) | 1.60 mm × 2.90 mm |

(1) For all available packages, see the orderable addendum at the end of the data sheet.

Simplified Schematic

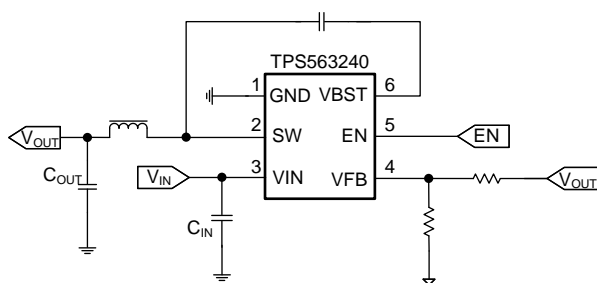

TPS563240 Efficiency

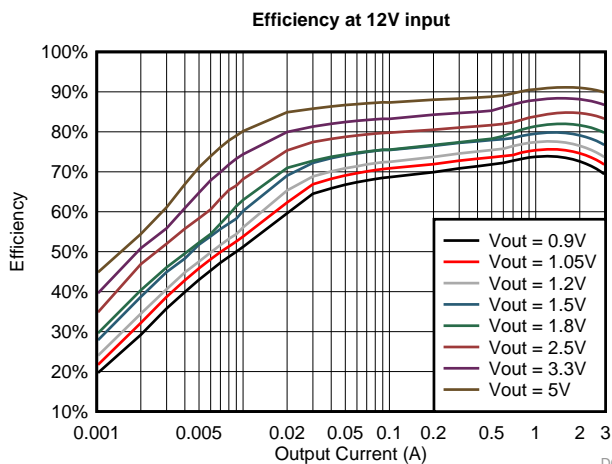

D001



Table of Contents

| | | | |
|--|---|--|----|
| 1 Features | 1 | 7.4 Device Functional Modes..... | 11 |
| 2 Applications | 1 | 8 Application and Implementation | 13 |
| 3 Description | 1 | 8.1 Application Information..... | 13 |
| 4 Revision History | 2 | 8.2 Typical Application | 13 |
| 5 Pin Configuration and Functions | 3 | 9 Power Supply Recommendations | 18 |
| 6 Specifications | 4 | 10 Layout | 19 |
| 6.1 Absolute Maximum Ratings | 4 | 10.1 Layout Guidelines | 19 |
| 6.2 ESD Ratings..... | 4 | 10.2 Layout Example | 19 |
| 6.3 Recommended Operating Conditions..... | 4 | 11 Device and Documentation Support | 20 |
| 6.4 Thermal Information | 4 | 11.1 Receiving Notification of Documentation Updates | 20 |
| 6.5 Electrical Characteristics..... | 5 | 11.2 Community Resources..... | 20 |
| 6.6 Typical Characteristics..... | 6 | 11.3 Trademarks | 20 |
| 7 Detailed Description | 9 | 11.4 Electrostatic Discharge Caution..... | 20 |
| 7.1 Overview | 9 | 11.5 Glossary | 20 |
| 7.2 Functional Block Diagram | 9 | 12 Mechanical, Packaging, and Orderable Information | 20 |
| 7.3 Feature Description..... | 9 | | |

4 Revision History

| Changes from Original (December 2018) to Revision A | Page |
|---|------|
| • Changed from 'with Out-of-Audio™ (OOA) operation...25kHz' to 'during light load...switching frequency'..... | 1 |
| • Deleted with Out-of-Audio™ (OOA) operation implemented..... | 1 |
| • Changed from 'Out-of-Audio™ (OOA) Operation ' to 'Light Load Operation Maintaining Above Audible Frequency' | 10 |
| • Deleted Out-of-Audio™ (OOA) operation under light-load condition is implemented. | 10 |

5 Pin Configuration and Functions

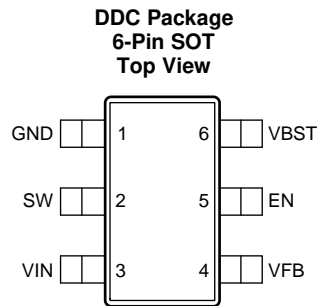

| PIN | | I/O | DESCRIPTION |
|------|-----|-----|---|
| NAME | NO. | | |
| GND | 1 | — | Ground pin Source terminal of low-side power NFET as well as the ground terminal for controller circuit. Connect sensitive VFB to this GND at a single point. |
| SW | 2 | O | Switch node connection between high-side NFET and low-side NFET. |
| VIN | 3 | I | Input voltage supply pin. The drain terminal of high-side power NFET. |
| VFB | 4 | I | Converter feedback input. Connect to output voltage with feedback resistor divider. |
| EN | 5 | I | Enable input control. Active high and must be pulled up to enable the device. |
| VBST | 6 | O | Supply input for the high-side NFET gate drive circuit. Connect 0.1 μ F capacitor between VBST and SW pins. |

6 Specifications

6.1 Absolute Maximum Ratings

over operating free-air temperature range (unless otherwise noted)⁽¹⁾

| | | MIN | MAX | UNIT |
|--|------------------------|------|-----------------------|------|
| Input voltage | V _{IN} | -0.3 | 19 | V |
| | VBST | -0.3 | 24.5 | V |
| | VBST (10 ns transient) | -0.3 | 26.5 | V |
| | VBST (vs SW) | -0.3 | 5.5 | V |
| | VFB | -0.3 | 5.5 | V |
| | SW | -2 | 19 | V |
| | SW (10 ns transient) | -3.5 | 21 | V |
| | EN | -0.3 | V _{IN} + 0.3 | V |
| Operating junction temperature, T _J | | -40 | 150 | °C |
| Storage temperature, T _{stg} | | -55 | 150 | °C |

(1) Stresses beyond those listed under *Absolute Maximum Ratings* may cause permanent damage to the device. These are stress ratings only, which do not imply functional operation of the device at these or any other conditions beyond those indicated under *Recommended Operating Conditions*. Exposure to absolute-maximum-rated conditions for extended periods may affect device reliability.

6.2 ESD Ratings

| | | | VALUE | UNIT |
|--------------------|-------------------------|--|-------|------|
| V _(ESD) | Electrostatic discharge | Human-body model (HBM), per ANSI/ESDA/JEDEC JS-001 ⁽¹⁾ | ±2000 | V |
| | | Charged-device model (CDM), per JEDEC specification JESD22-C101 ⁽²⁾ | ±500 | |

(1) JEDEC document JEP155 states that 500-V HBM allows safe manufacturing with a standard ESD control process.

(2) JEDEC document JEP157 states that 250-V CDM allows safe manufacturing with a standard ESD control process.

6.3 Recommended Operating Conditions

over operating free-air temperature range (unless otherwise noted)

| | | MIN | NOM | MAX | UNIT |
|-----------------|--------------------------------|------|-----|-----------------|------|
| V _{IN} | Supply input voltage range | 4.5 | | 17 | V |
| EN | EN Input voltage range | -0.1 | | V _{IN} | V |
| T _J | Operating junction temperature | -40 | | 125 | °C |

6.4 Thermal Information

| THERMAL METRIC ⁽¹⁾ | | TPS563240 | UNIT |
|-------------------------------|--|-----------|------|
| | | DDC (SOT) | |
| | | 6 PINS | |
| R _{θJA} | Junction-to-ambient thermal resistance | 117.1 | °C/W |
| R _{θJC(top)} | Junction-to-case (top) thermal resistance | 57.3 | °C/W |
| R _{θJB} | Junction-to-board thermal resistance | 31.2 | °C/W |
| ψ _{JT} | Junction-to-top characterization parameter | 11.2 | °C/W |
| ψ _{JB} | Junction-to-board characterization parameter | 31.3 | °C/W |

(1) For more information about traditional and new thermal metrics, see the [Semiconductor and IC Package Thermal Metrics](#) application report.

6.5 Electrical Characteristics

 $T_J = -40^{\circ}\text{C}$ to 125°C , $V_{IN} = 12\text{ V}$ (unless otherwise noted)

| PARAMETER | | TEST CONDITIONS | MIN | TYP | MAX | UNIT |
|---|---|--|------|------|----------|--------------------|
| SUPPLY CURRENT | | | | | | |
| I_{VIN} | Operating – non-switching supply current | V_{IN} current, $EN = 5\text{ V}$, $V_{FB} = 0.7\text{ V}$, $T_J = 25^{\circ}\text{C}$ | | 235 | 300 | μA |
| $I_{VIN(SDN)}$ | Shutdown supply current | V_{IN} current, $EN = 0\text{ V}$, $T_J = 25^{\circ}\text{C}$ | | 2.5 | 10 | μA |
| LOGIC THRESHOLD | | | | | | |
| V_{ENH} | Enable threshold | Rising | | 1.27 | 1.34 | V |
| V_{ENL} | Enable threshold | Falling | 1.08 | 1.15 | | V |
| R_{EN} | EN pin resistance to GND | $V_{EN} = 1\text{ V}$ | 800 | 1000 | 1200 | $\text{k}\Omega$ |
| V_{FB} VOLTAGE AND DISCHARGE RESISTANCE | | | | | | |
| V_{FB} | FB voltage | Continuous mode operation, $T_J = 25^{\circ}\text{C}$ | 594 | 600 | 606 | mV |
| | | Continuous mode operation | 588 | 600 | 612 | mV |
| I_{FB} | FB input current | $V_{FB} = 0.7\text{ V}$ | | 0 | ± 50 | nA |
| MOSFET | | | | | | |
| $R_{DS(on)h}$ | High-side switch resistance | $T_J = 25^{\circ}\text{C}$ | | 70 | | $\text{m}\Omega$ |
| $R_{DS(on)l}$ | Low-side switch resistance | $T_J = 25^{\circ}\text{C}$ | | 30 | | $\text{m}\Omega$ |
| CURRENT LIMIT | | | | | | |
| $I_{ocl_h_source}$ | High side FET source Current limit | | 5.5 | 6.3 | 7.1 | A |
| $I_{ocl_l_source}$ | Low side FET source Current limit | | 3.1 | 3.9 | 4.7 | A |
| $I_{ocl_l_sink}$ | Low side FET sink Current limit | | | 0 | | A |
| THERMAL SHUTDOWN | | | | | | |
| T_{SDN} | Thermal shutdown threshold ⁽¹⁾ | Shutdown temperature | | 160 | | $^{\circ}\text{C}$ |
| | | Hysteresis | | 25 | | |
| ON-TIME TIMER CONTROL | | | | | | |
| $t_{ON(MIN)}$ | Minimum on time ⁽¹⁾ | $V_{IN} = 12\text{ V}$, load = 3 A | | 50 | | ns |
| $t_{OFF(MIN)}$ | Minimum off time | | | 250 | | ns |
| SOFT START | | | | | | |
| t_{ss} | Soft-start time | Internal soft-start time | | 1.7 | | ms |
| FREQUENCY | | | | | | |
| F_{sw} | Switching frequency | | | 1400 | | kHz |
| OUTPUT UNDERVOLTAGE PROTECTION | | | | | | |
| V_{UVP} | Output UVP threshold | Hiccup detect ($H > L$) | | 65% | | |
| t_{UVPDLY} | UVP propagation delay | | | 0.36 | | ms |
| t_{HIC} | UVP protection Hiccup Time before restart | | | 25 | | ms |
| UVLO | | | | | | |
| UVLO | UVLO threshold | Wake up V_{IN} voltage | | 4.2 | 4.4 | V |
| | | Shutdown V_{IN} voltage | 3.6 | 3.8 | | |
| | | Hysteresis V_{IN} voltage | | 0.4 | | |

(1) Not production tested.

6.6 Typical Characteristics

$V_{IN} = 12\text{ V}$ (unless otherwise noted)

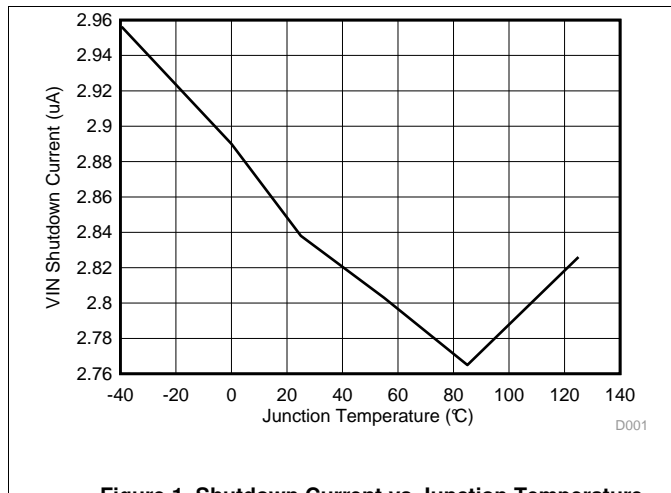

Figure 1. Shutdown Current vs Junction Temperature

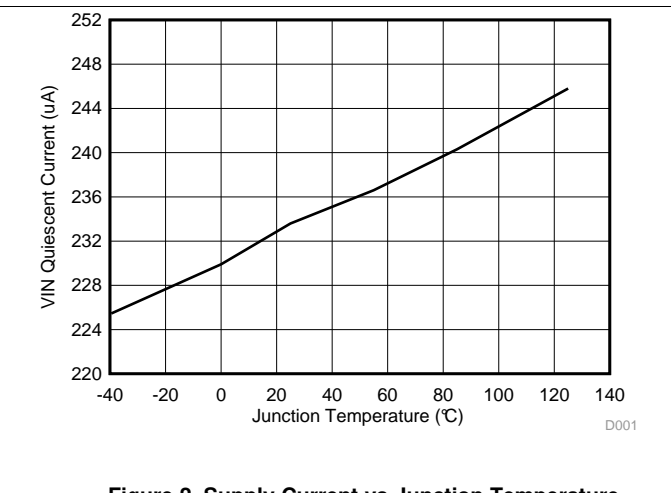

Figure 2. Supply Current vs Junction Temperature

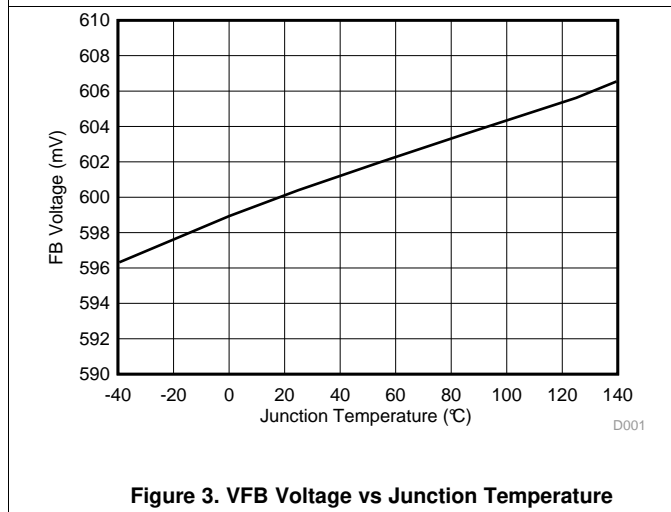

Figure 3. VFB Voltage vs Junction Temperature

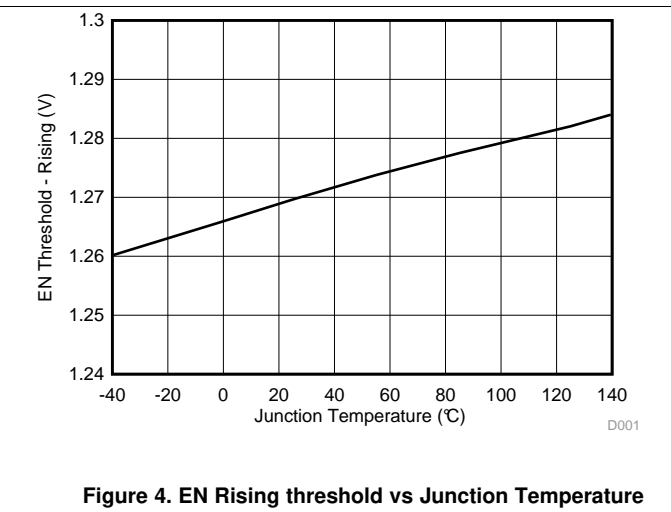

Figure 4. EN Rising threshold vs Junction Temperature

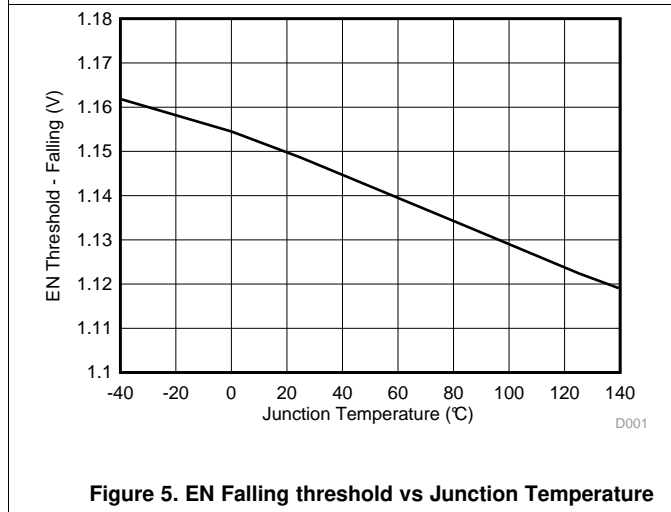

Figure 5. EN Falling threshold vs Junction Temperature

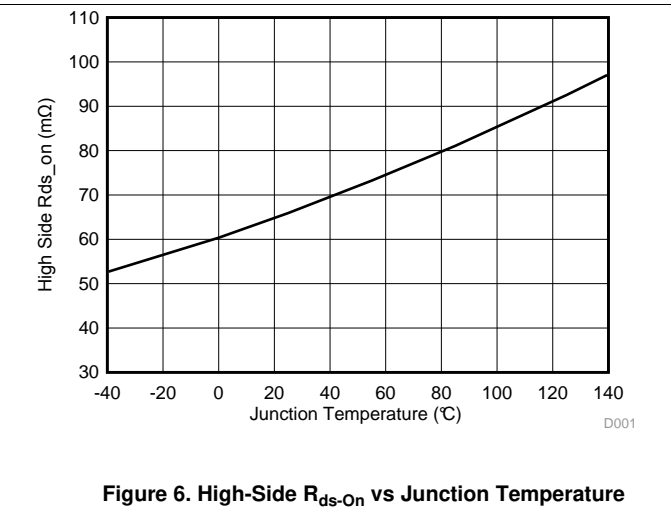
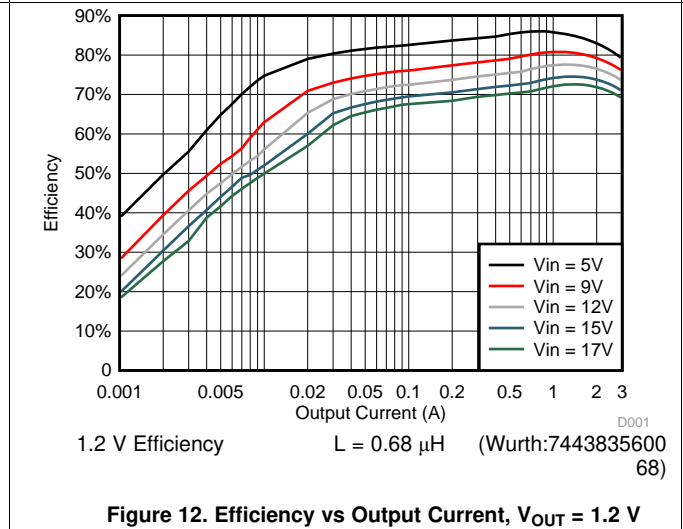
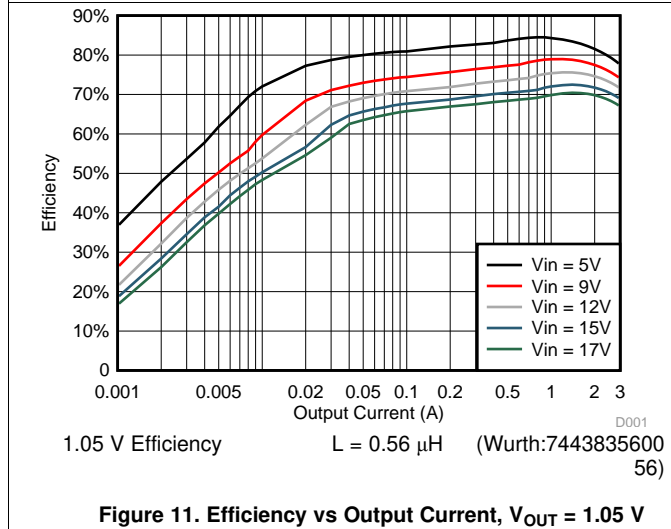
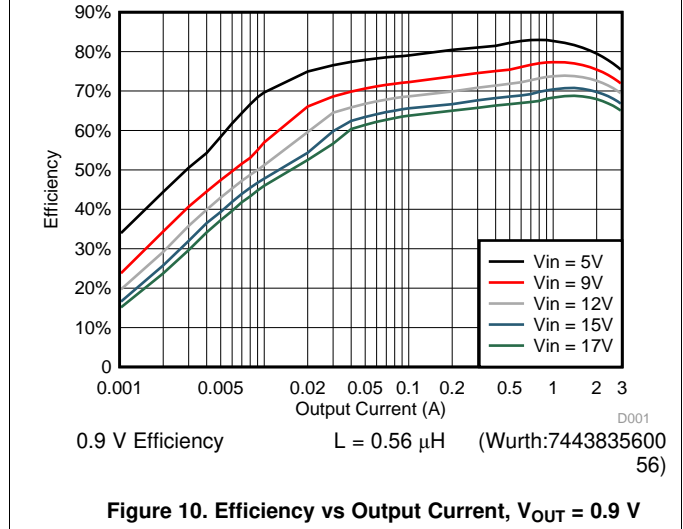
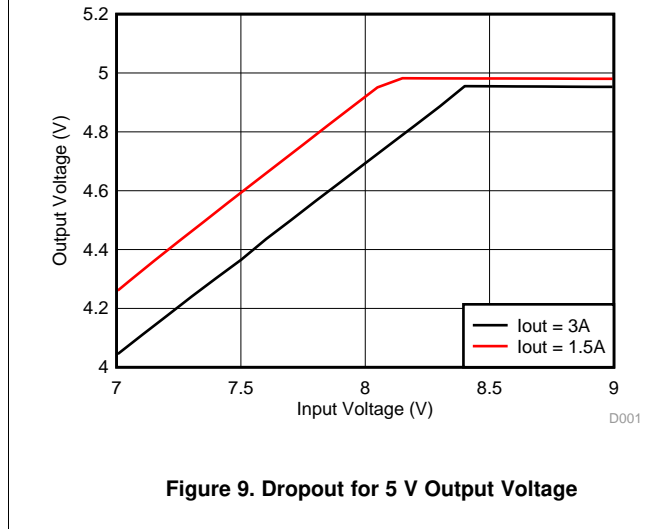
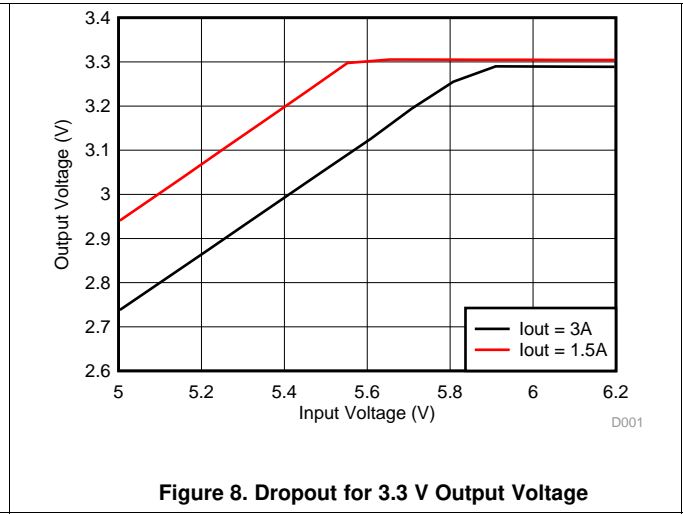
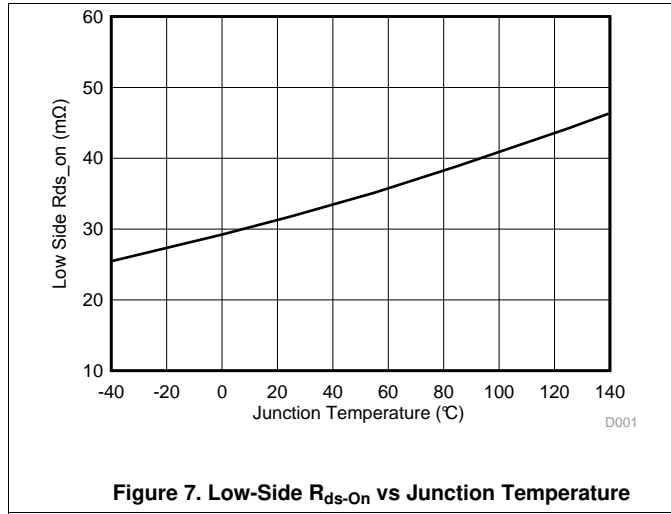

Figure 6. High-Side R_{ds-On} vs Junction Temperature

Typical Characteristics (continued)

V_{IN} = 12 V (unless otherwise noted)



Typical Characteristics (continued)

V_{IN} = 12 V (unless otherwise noted)

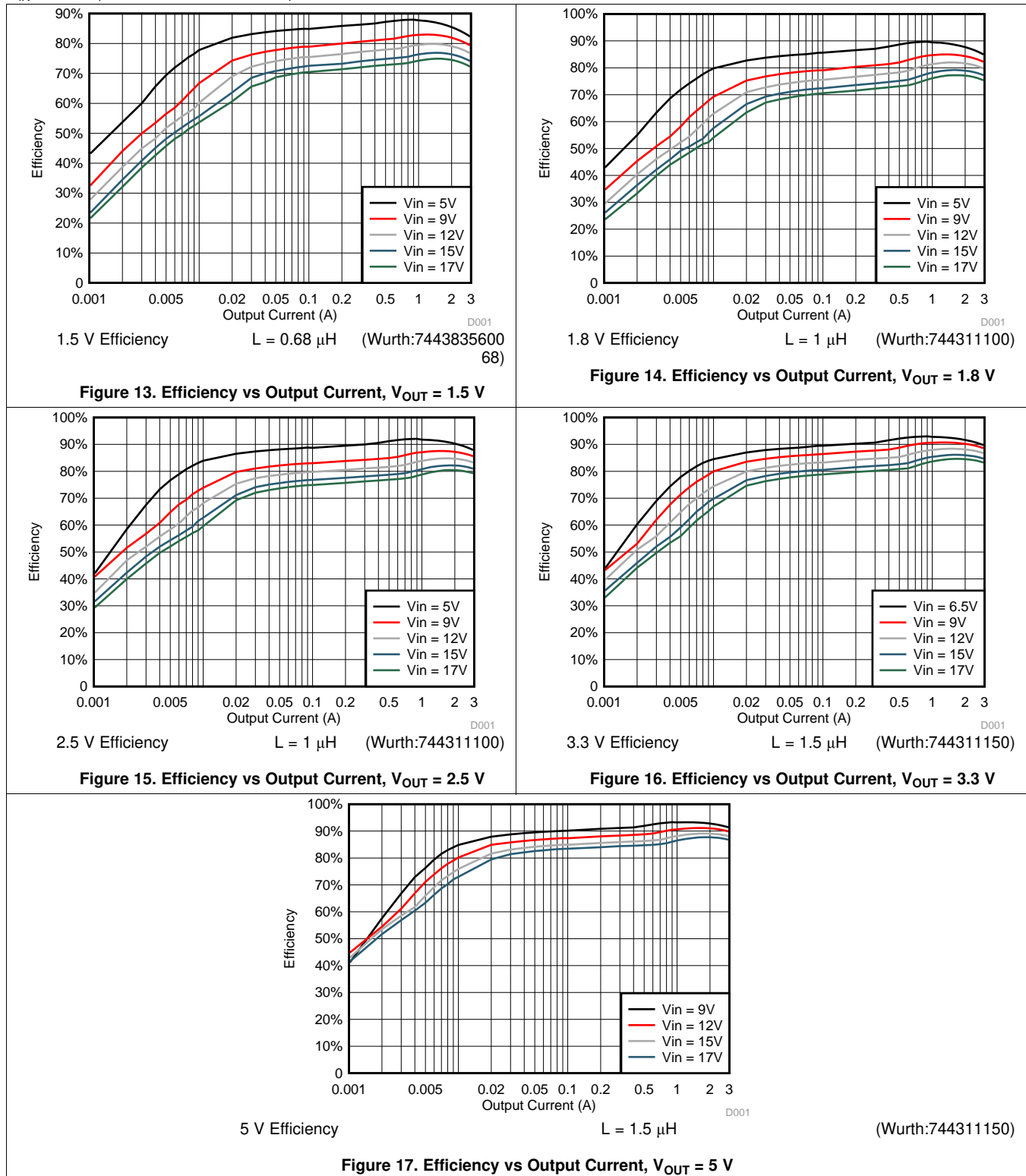

7 Detailed Description

7.1 Overview

The TPS563240 is a 3-A synchronous step-down converter. The proprietary D-CAP3 mode control supports low ESR output capacitors such as specialty polymer capacitors and multi-layer ceramic capacitors without complex external compensation circuits. The fast transient response of D-CAP3 mode control can reduce the output capacitance required to meet a specific level of performance.

7.2 Functional Block Diagram

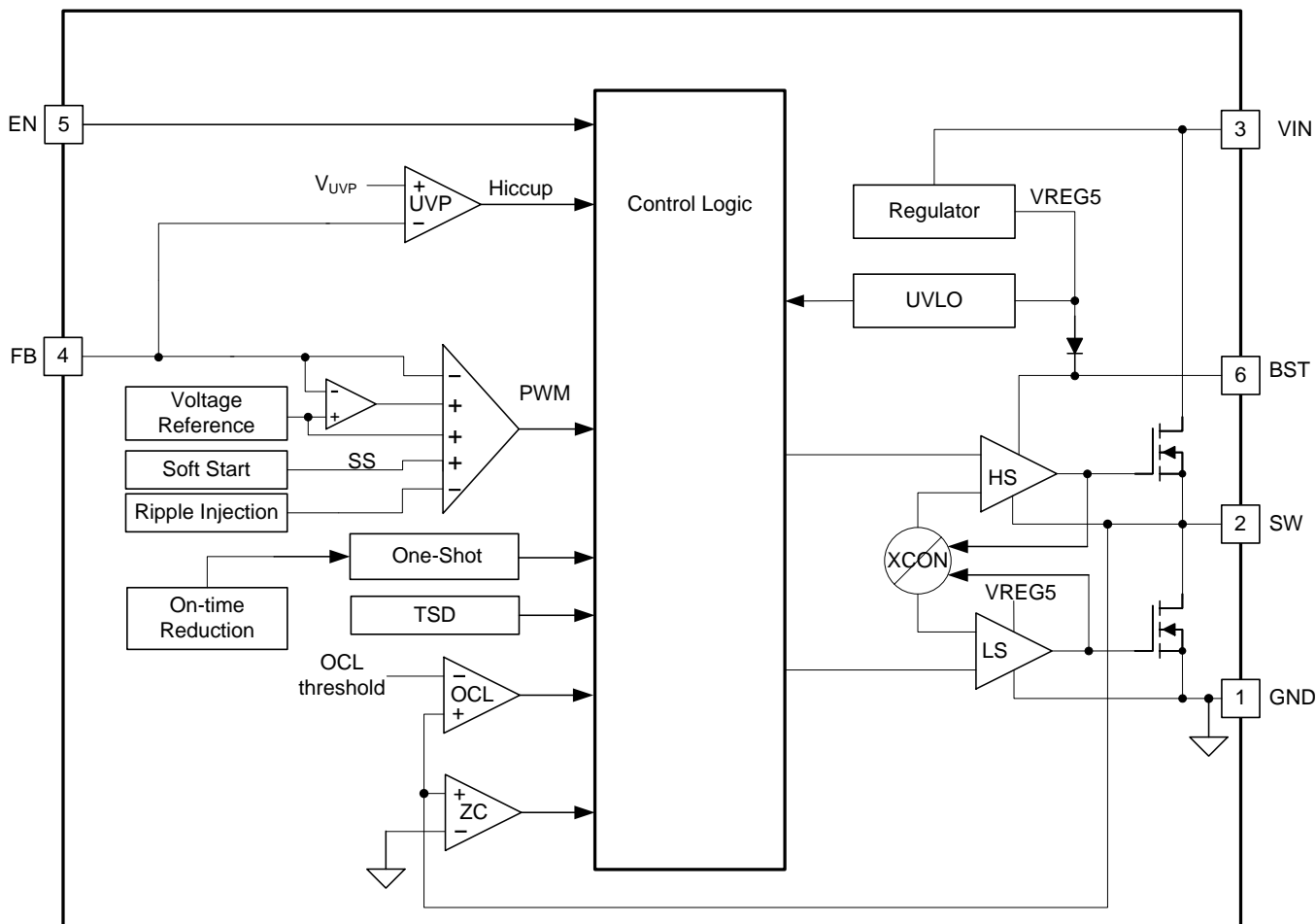

7.3 Feature Description

7.3.1 Adaptive On-Time Control and PWM Operation

The main control loop of the TPS563240 is adaptive on-time pulse width modulation (PWM) controller that supports a proprietary D-CAP3 mode control. The D-CAP3 mode control combines adaptive on-time control with an internal compensation circuit for pseudo-fixed frequency and low external component count configuration with both low-ESR and ceramic output capacitors. It is stable even with virtually no ripple at the output.

At the beginning of each cycle, the high-side MOSFET is turned on. This MOSFET is turned off after internal one shot timer expires. This one shot duration is set proportional to the converter input voltage, V_{IN} , and inversely proportional to the output voltage, V_O , to maintain a pseudo-fixed frequency over the input voltage range, hence it is called adaptive on-time control. The one-shot timer is reset and the high-side MOSFET is turned on again when the feedback voltage falls below the reference voltage. An internal ramp is added to reference voltage to simulate output ripple, eliminating the need for ESR induced output ripple from D-CAP3 mode control.

Feature Description (continued)

7.3.2 Pulse Skip Control

The TPS563240 is designed with advanced Eco-mode to maintain high light load efficiency. As the output current decreases from heavy load condition, the inductor current is also reduced and eventually comes to point that its rippled valley touches zero level, which is the boundary between continuous conduction and discontinuous conduction modes. The rectifying MOSFET is turned off when the zero inductor current is detected. As the load current further decreases the converter runs into discontinuous conduction mode. The on-time is kept almost the same as it was in the continuous conduction mode so that it takes longer time to discharge the output capacitor with smaller load current to the level of the reference voltage. This makes the switching frequency lower, proportional to the load current, and keeps the light load efficiency high. The transition point to the light load operation $I_{OUT(LL)}$ current can be calculated in Equation 1.

$$I_{OUT(LL)} = \frac{1}{2 \times L \times f_{SW}} \times \frac{(V_{IN} - V_{OUT}) \times V_{OUT}}{V_{IN}} \tag{1}$$

7.3.3 Light Load Operation Maintaining Above Audible Frequency

As the load current continues to decrease, the switching frequency can decrease into the acoustic audible frequency range. To prevent this from happening, the control circuit monitors the states of both the high-side and low-side FETs. When both high-side and low-side FETs are off for a period longer than 30 μ s, the on time generated by one shot timer is decreased by a little step, thus the off time of both FETs will be reduced to a length lower than 30 μ s. If the load current decreases further, and cause the off time of both FETs longer than 30 μ s again, the above described on time reduction process will repeat. By this means, the switching frequency is maintained higher than ~33kHz as load decrease. When the on time reduces to ~30% of that in CCM operation, the on time will keep at this minimum length. If load current decreases further, the switching frequency can't be maintained at ~33kHz anymore, instead, it will decrease linearly towards zero.

When the load current increases from zero, the on time is kept at minimum length, which is ~30% of that in CCM operation, and the switching frequency increases linearly as load increases. When the off time of both FETs decreases to a length lower than 20 μ s, the on time generated by one shot timer will increase by a step, thus the off time of both FETs will be increased above 20 μ s. If the load current increases further, and cause the off time of both FETs shorter than 20 μ s again, the above described on time increase process will repeat. By this means, the switching frequency is maintained lower than ~50 kHz as load increases. When the on time increases to the length of that in CCM operation, the on time can't be increased anymore. If load current continue increases, the switching frequency will increase linearly towards 1.4MHz nominal frequency. Below figure shows the frequency VS load curve at 12Vin/5Vout condition with 1.5 μ H inductor used.

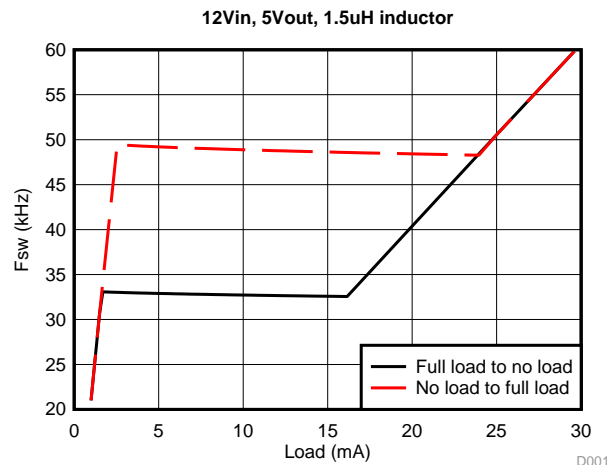

Figure 18. Frequency VS load current at 12Vin/5Vout condition with 1.5 μ H inductor used

7.3.4 Soft Start and Pre-Biased Soft Start

The TPS563240 has an internal 1.7-ms soft-start. When the EN pin becomes high, the internal soft-start function begins ramping up the reference voltage to the PWM comparator.

Feature Description (continued)

If the output capacitor is pre-biased at startup, the devices initiate switching and start ramping up only after the internal reference voltage becomes greater than the feedback voltage V_{FB} . This scheme ensures that the converters ramp up smoothly into regulation point.

7.3.5 Current Protection

There are two kinds of current protection in TPS563240: High-side FET source current limit and low-side FET source current limit.

The output over-current limit (OCL) is implemented using a cycle-by-cycle valley detect control circuit. The switch current is monitored during the OFF state by measuring the low-side FET drain to source voltage. This voltage is proportional to the switch current. To improve accuracy, the voltage sensing is temperature compensated.

During the on time of the low-side FET switch, the inductor current flow through low-side FET and decreases linearly. The average value of the inductor current is the load current I_{OUT} . If the monitored current is above the low-side FET source current limit level, the converter maintains low-side FET on and delays the creation of a new set pulse, even the voltage feedback loop requires one, until the current cross the low-side FET source current limit level. In subsequent switching cycles, the on-time is set to a fixed value and the current is monitored in the same manner.

There are some important considerations for this type of over-current protection. The load current is higher than the over-current threshold by one half of the peak-to-peak inductor ripple current. Also, when the current is being limited, the output voltage tends to fall as the demanded load current may be higher than the current available from the converter. This may cause the output voltage to fall. When the V_{FB} voltage falls below the UVP threshold voltage, the UVP comparator detects it. And then, the device will shut down after the UVP delay time (typically 0.36 ms) and re-start after the hiccup time (typically 25 ms).

When the over current condition is removed, the output voltage returns to the regulated value.

During the on time of the high-side FET switch, the inductor current flow through high-side FET and increases at a linear rate determined by V_{IN} , V_{OUT} , the on-time and the output inductor value. The switch current is compared with high-side FET source current limit after a short blanking time. If the cross-limit event detected before the one shot timer expires, the high-side FET will be turn off immediately, and will not be allowed on in the following 1 μ s period.

7.3.6 Undervoltage Lockout (UVLO) Protection

UVLO protection monitors the internal regulator voltage. When the voltage is lower than UVLO threshold voltage, the device is shut off. This protection is non-latching.

7.3.7 Thermal Shutdown

The device monitors the temperature of itself. If the temperature exceeds the threshold value (typically 160°C), the device is shut off. This is a non-latch protection.

7.4 Device Functional Modes

7.4.1 Normal Operation

When the input voltage is above the UVLO threshold and the EN voltage is above the enable threshold, the TPS563240 can operate in normal switching modes. Normal continuous conduction mode (CCM) occurs when the minimum switch current is above 0 A. In CCM, the TPS563240 operates at a quasi-fixed frequency of 1.4MHz.

7.4.2 Eco-mode Operation

When the TPS563240 is in the normal CCM operating mode and the switch current falls to 0 A, the TPS563240 begins operating in pulse skipping Eco-mode. Each switching cycle is followed by a period of energy saving sleep time. The sleep time ends when the V_{FB} voltage falls below reference voltage. As the output current decreases, the sleep time between switching pulses increases.

Device Functional Modes (continued)

7.4.3 Standby Operation

When the TPS563240 is operating in either normal CCM or Eco-mode, it may be placed in standby by asserting the EN pin low.

8 Application and Implementation

NOTE

Information in the following applications sections is not part of the TI component specification, and TI does not warrant its accuracy or completeness. TI's customers are responsible for determining suitability of components for their purposes. Customers should validate and test their design implementation to confirm system functionality.

8.1 Application Information

The device is a typical step-down DC-DC converter. It's typically used to convert a higher dc voltage to a lower dc voltage with a maximum available output current of 3 A. The following design procedure can be used to select component values for the TPS563240. Alternately, the WEBENCH® software may be used to generate a complete design. The WEBENCH software uses an iterative design procedure and accesses a comprehensive database of components when generating a design. This section presents a simplified discussion of the design process.

8.2 Typical Application

The application schematic in Figure 19 was developed to meet the previous requirements. This circuit is available as the evaluation module (EVM). The sections provide the design procedure.

Figure 19 shows the TPS563240 6.5-V to 17-V input, 3.3-V output converter schematics.

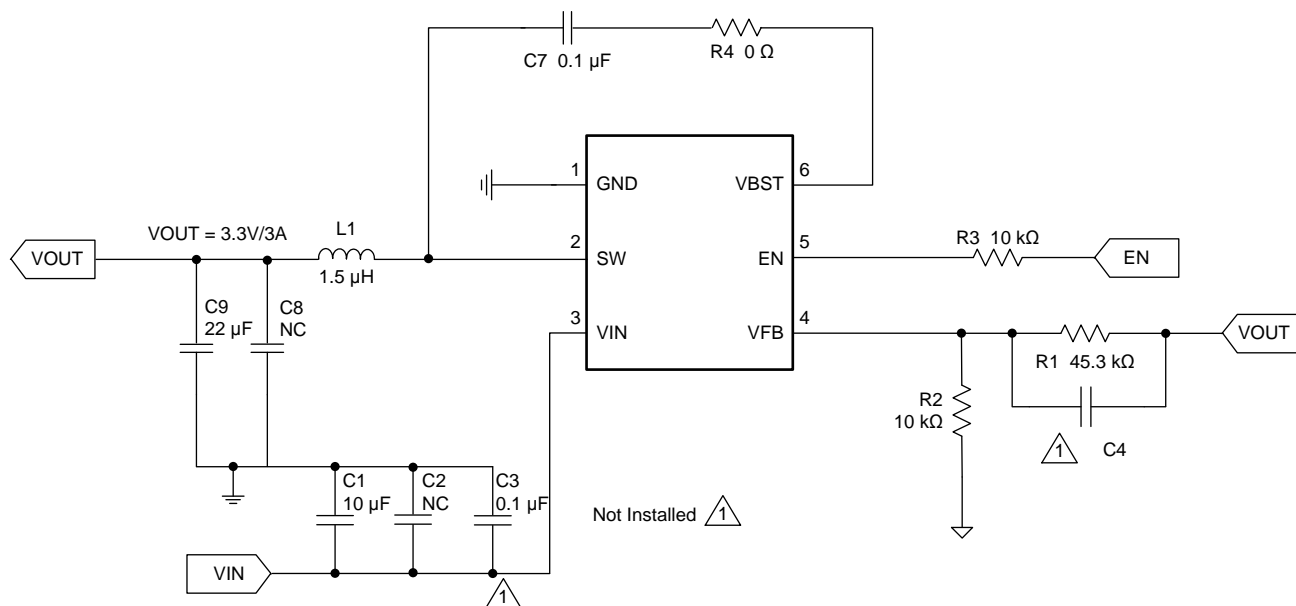

Figure 19. 3.3-V/3-A Reference Design

Typical Application (continued)

8.2.1 Design Requirements

Table 1 shows the design parameters for this application.

Table 1. Design Parameters

| PARAMETER | EXAMPLE VALUE |
|-------------------------------------|----------------------------|
| Input voltage range | 6.5 to 17 V |
| Output voltage | 3.3 V |
| Transient response, 1.5-A load step | $\Delta V_{out} = \pm 5\%$ |
| Input ripple voltage | 400 mV |
| Output ripple voltage | 100 mV |
| Output current rating | 3 A |
| Operating frequency | 1.4 MHz |

8.2.2 Detailed Design Procedure

8.2.2.1 Output Voltage Resistors Selection

The output voltage is set with a resistor divider from the output node to the VFB pin. TI recommends to use 1% tolerance or better divider resistors. Start by using Equation 2 to calculate V_{OUT} .

To improve efficiency at very light loads consider using larger value resistors, too high of resistance will be more susceptible to noise and voltage errors from the VFB input current will be more noticeable.

$$V_{OUT} = 0.6 \times \left(1 + \frac{R1}{R2}\right) \quad (2)$$

8.2.2.2 Output Filter Selection

The LC filter used as the output filter has double pole at:

$$f_p = \frac{1}{2\pi\sqrt{L_{OUT} \times C_{OUT}}} \quad (3)$$

At low frequencies, the overall loop gain is set by the output set-point resistor divider network and the internal gain of the device. The low frequency phase is 180°. At the output filter pole frequency, the gain rolls off at a –40 dB per decade rate and the phase drops rapidly. D-CAP3 introduces a high frequency zero that reduces the gain roll off to –20 dB per decade and increases the phase to 90° one decade above the zero frequency. The inductor and capacitor for the output filter must be selected so that the double pole of Equation 3 is located below the high frequency zero but close enough that the phase boost provided by the high frequency zero provides adequate phase margin for a stable circuit. To meet this requirement use the values recommended in Table 2.

Table 2. Recommended Component Values

| OUTPUT VOLTAGE (V) | R1 (k Ω) | R2 (k Ω) | L1 (μ H) | | | C8 + C9 (μ F) |
|--------------------|------------------|------------------|---------------|------|-----|--------------------|
| | | | MIN | TYP | MAX | |
| 1 | 6.65 | 10.0 | 0.33 | 0.56 | 1 | 10 to 44 |
| 1.05 | 7.5 | 10.0 | 0.33 | 0.56 | 1 | 10 to 44 |
| 1.2 | 10 | 10.0 | 0.47 | 0.68 | 1.5 | 10 to 44 |
| 1.5 | 15 | 10.0 | 0.47 | 0.82 | 1.5 | 10 to 44 |
| 1.8 | 20 | 10.0 | 0.56 | 1 | 2.2 | 10 to 44 |
| 2.5 | 31.6 | 10.0 | 0.68 | 1 | 2.2 | 10 to 44 |
| 3.3 | 45.3 | 10.0 | 0.82 | 1.5 | 3.3 | 10 to 44 |
| 5 | 73.2 | 10.0 | 1 | 1.5 | 3.3 | 10 to 44 |
| 6.5 | 97.6 | 10.0 | 1 | 1.5 | 3.3 | 10 to 44 |

The inductor peak-to-peak ripple current, peak current and RMS current are calculated using [Equation 4](#), [Equation 5](#), and [Equation 6](#). The inductor saturation current rating must be greater than the calculated peak current and the RMS or heating current rating must be greater than the calculated RMS current.

$$I_{P-P} = \frac{V_{OUT}}{V_{IN(MAX)}} \times \frac{V_{IN(MAX)} - V_{OUT}}{L_O \times f_{SW}} \quad (4)$$

$$I_{PEAK} = I_O + \frac{I_{P-P}}{2} \quad (5)$$

$$I_{LO(RMS)} = \sqrt{I_O^2 + \frac{1}{12} I_{P-P}^2} \quad (6)$$

For this design example, the calculated peak current is 3.63 A and the calculated RMS current is 3.02 A. The inductor used is a WE 744311150 with a rated current of 11 A.

The capacitor value and ESR determines the amount of output voltage ripple. The TPS563240 is intended for use with ceramic or other low ESR capacitors. Recommended values range from 10 μ F to 44 μ F. Use [Equation 7](#) to determine the required RMS current rating for the output capacitor.

$$I_{CO(RMS)} = \frac{V_{OUT} \times (V_{IN} - V_{OUT})}{\sqrt{12} \times V_{IN} \times L_O \times f_{SW}} \quad (7)$$

For this design one Murata GRM31CR61A226KE19 22- μ F output capacitor is used. The typical ESR is 2 m Ω . The calculated RMS current is 0.365 A and output capacitor is rated for 4 A.

8.2.2.3 Input Capacitor Selection

The TPS563240 requires an input decoupling capacitor and a bulk capacitor is needed depending on the application. TI recommends a ceramic capacitor over 10 μ F for the decoupling capacitor. An additional 0.1- μ F capacitor (C3) from pin 3 to ground is optional to provide additional high frequency filtering. The capacitor voltage rating needs to be greater than the maximum input voltage.

8.2.2.4 Bootstrap Capacitor Selection

A 0.1- μ F ceramic capacitor must be connected between the VBST to SW pin for proper operation. TI recommends to use a ceramic capacitor.

8.2.2.5 Dropout

With a constant 1.4-MHz switching frequency, there is a minimum input voltage limit for a given output voltage to be regulated. This is due to the minimum off time limit. If the input voltage less than the minimum input voltage limit, the output voltage drops accordingly, which is called dropout condition. [Figure 8](#) and [Figure 9](#) show the typical dropout curve for 3.3 V and 5 V output voltage with 3 A and 1.5 A load respectively. [Equation 8](#) can be used to estimate this minimum input voltage limit.

$$V_{IN(MIN)} = \frac{\frac{V_{OUT}}{F_{SW}} + (R_{dsl} + R_L) \times I_O \times (t_{off(min)} - t_{d1} - t_{d2}) + (V_d + R_L \times I_O) \times (t_{d1} + t_{d2})}{\frac{1}{F_{SW}} - t_{off(min)}} + (R_{dsh} + R_L) \times I_O$$

where

- V_{OUT} = target output voltage
- F_{SW} = maximum switching frequency including tolerance
- $t_{off(min)}$ = minimum off time including tolerance
- R_{dsl} = low side FET on resistance
- R_{dsh} = high side FET on resistance
- R_L = inductor DC resistance
- I_O = maximum load current
- t_{d1} = dead time between high side FET off and low side FET on, 15nS typical
- t_{d2} = dead time between low side FET off and high side FET on, 10nS typical
- V_d = forward voltage of low side FET body diode

(8)

8.2.3 Application Curves

$T_A = 25^\circ\text{C}$, $V_{IN} = 12\text{ V}$ (unless otherwise noted)

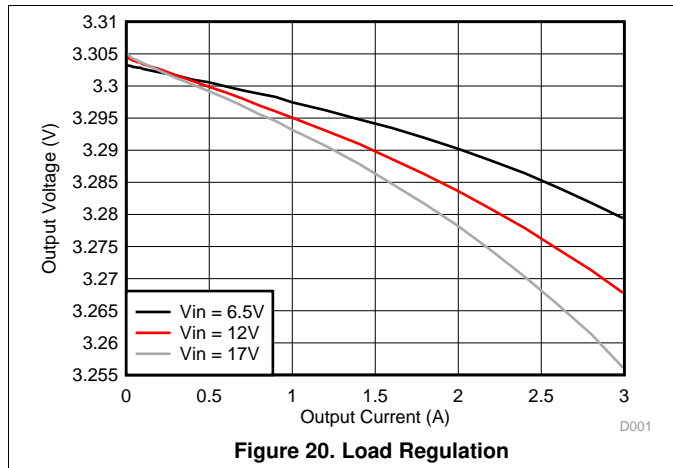

Figure 20. Load Regulation

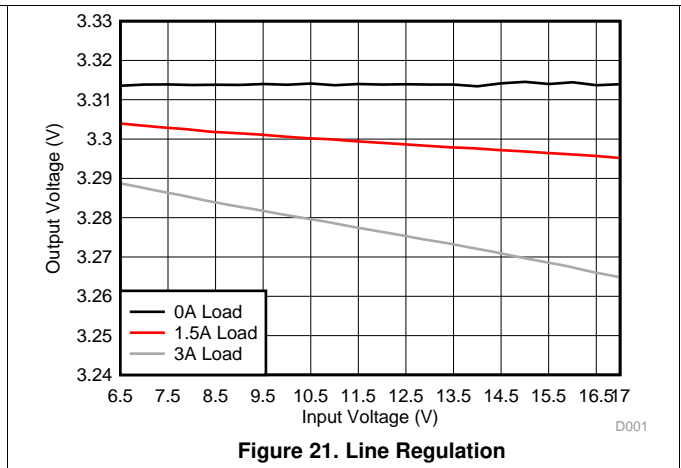

Figure 21. Line Regulation

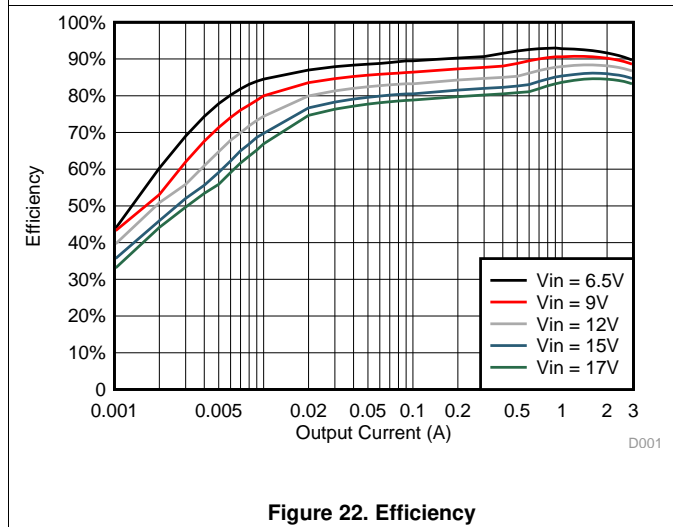

Figure 22. Efficiency

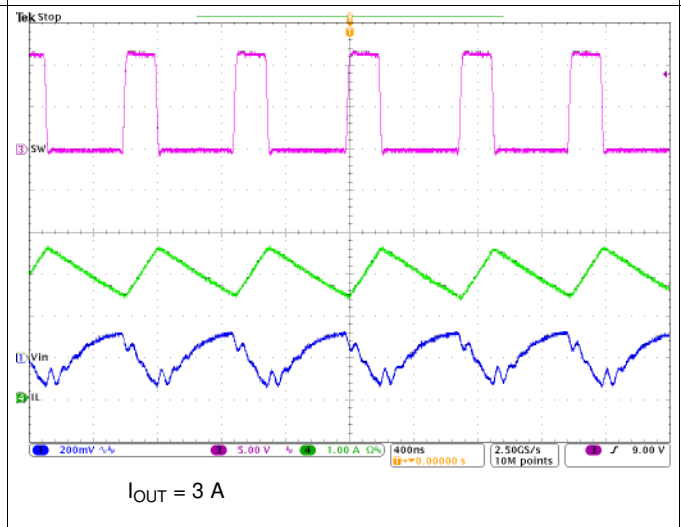

Figure 23. Input Voltage Ripple

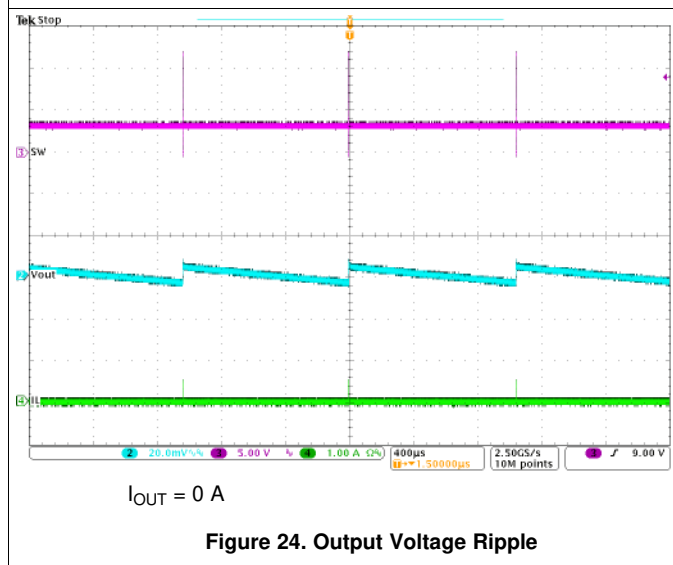

Figure 24. Output Voltage Ripple

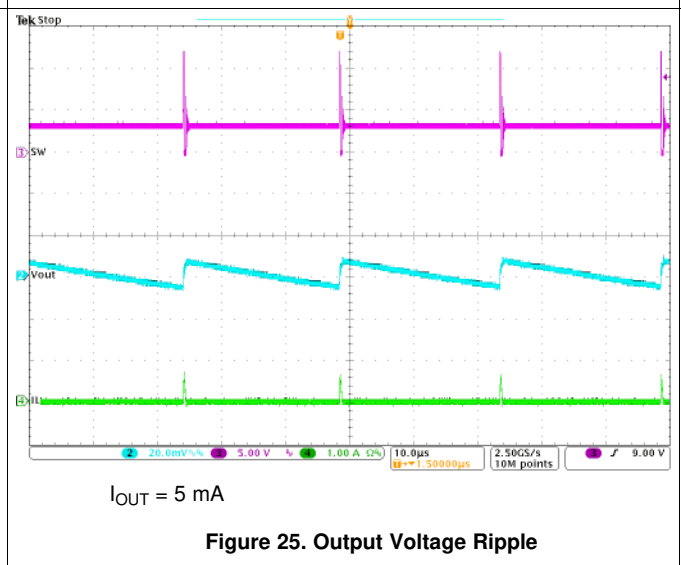
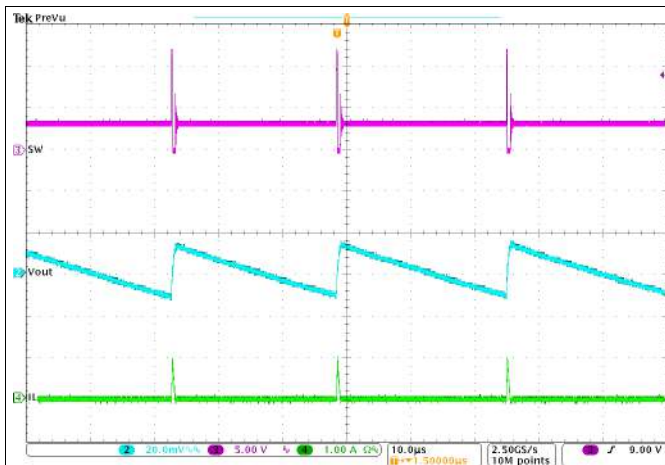
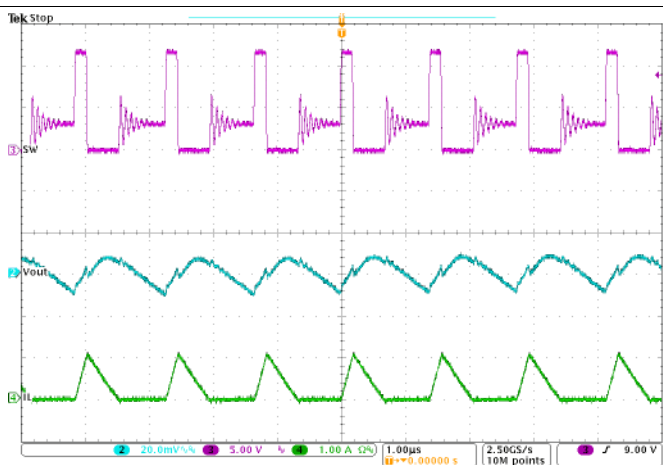

Figure 25. Output Voltage Ripple



$I_{OUT} = 10 \text{ mA}$

Figure 26. Output Voltage Ripple



$I_{OUT} = 0.25 \text{ A}$

Figure 27. Output Voltage Ripple

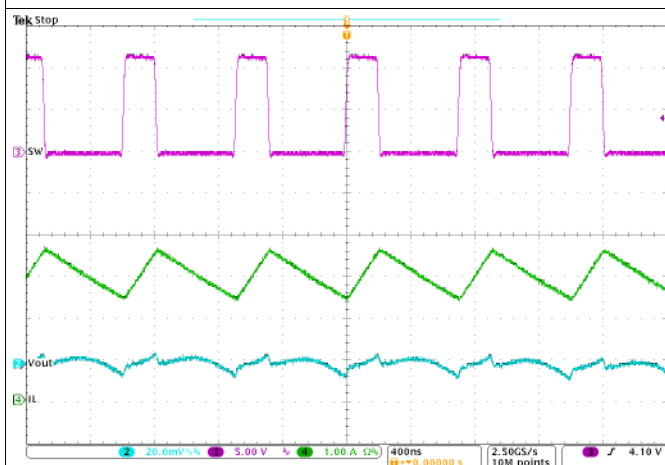

$I_{OUT} = 3 \text{ A}$

Figure 28. Output Voltage Ripple

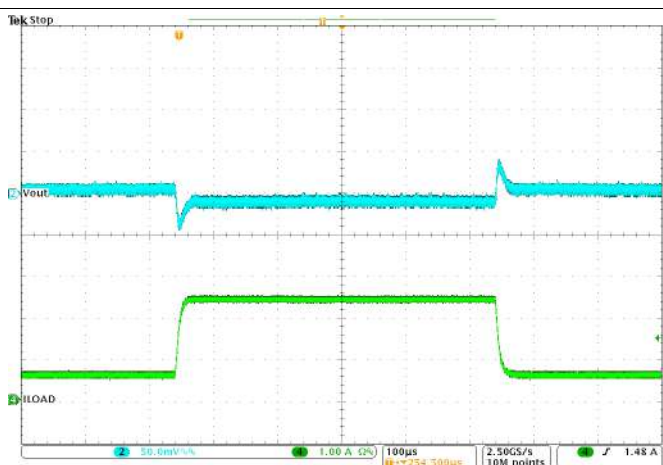

Slew rate is $1.6\text{A}/\mu\text{s}$

Figure 29. Transient Response, 0.6 to 2.4A

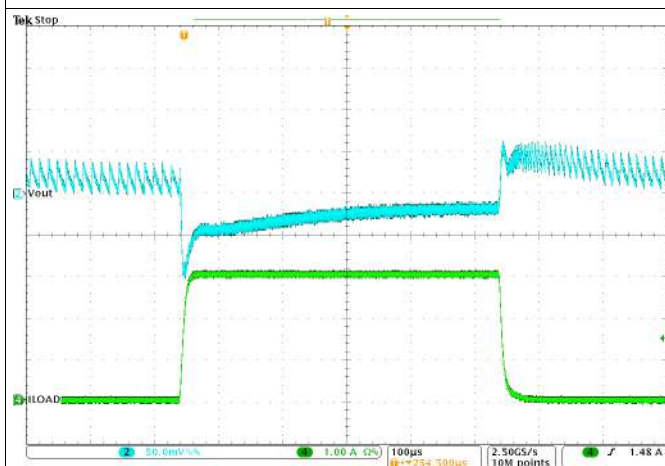

Slew rate is $1.6\text{A}/\mu\text{s}$

Figure 30. Transient Response, 0 to 3 A

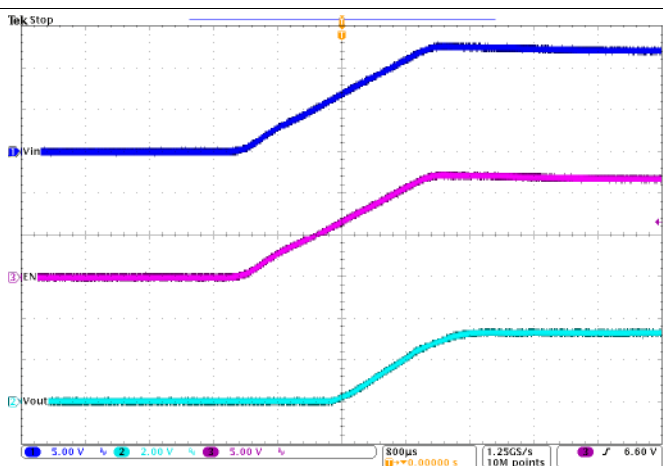

$I_{OUT} = 0 \text{ A}$

Figure 31. Start Up Relative to V_{IN}

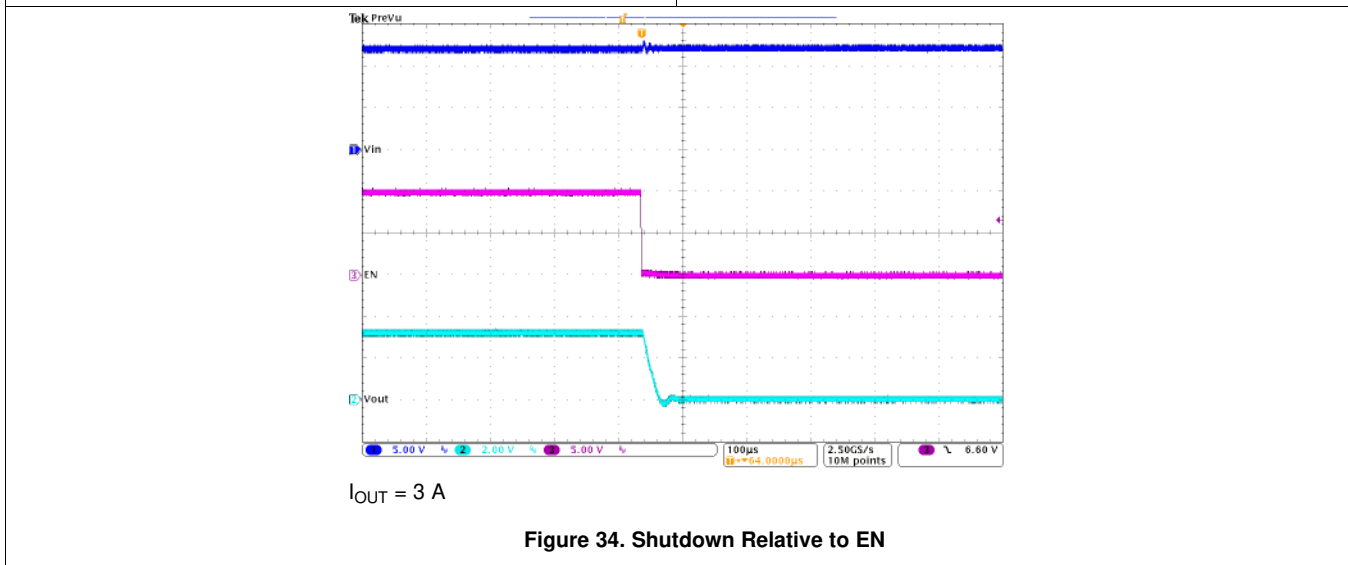
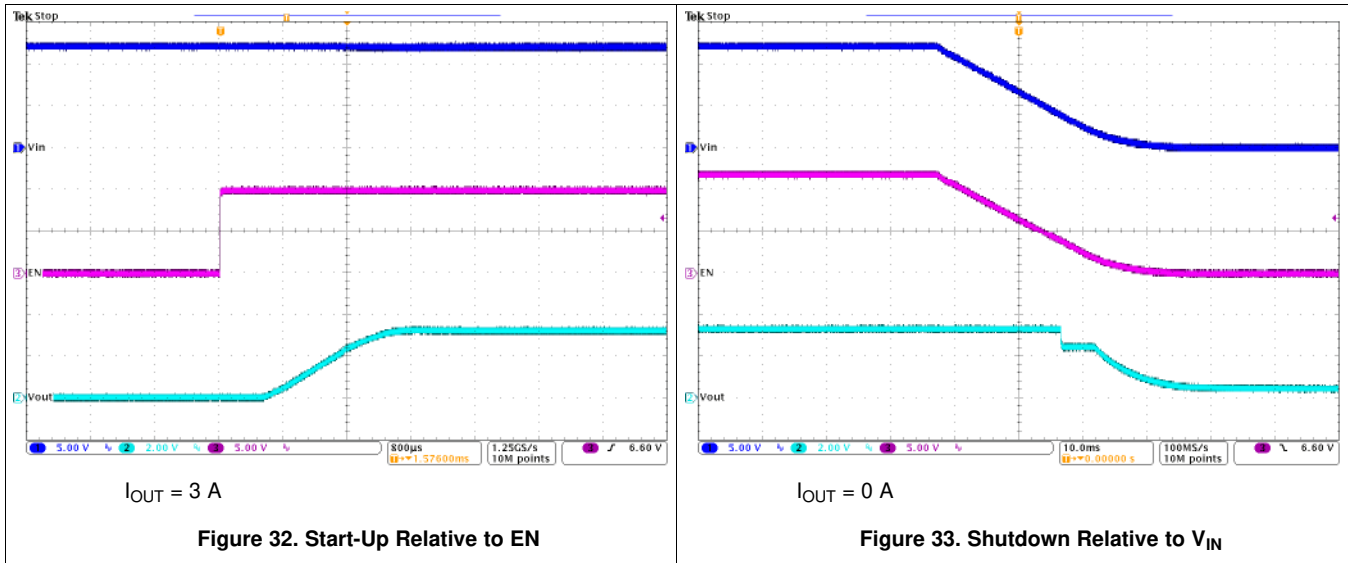

9 Power Supply Recommendations

TPS563240 is designed to operate from input supply voltage in the range of 4.5 V to 17 V. Buck converters require the input voltage to be higher than the output voltage for proper operation.

10 Layout

10.1 Layout Guidelines

1. VIN and GND traces should be as wide as possible to reduce trace impedance. The wide areas are also of advantage from the view point of heat dissipation.
2. The input capacitor and output capacitor should be placed as close to the device as possible to minimize trace impedance.
3. Provide sufficient vias for the input capacitor and output capacitor.
4. Keep the SW trace as physically short and wide as practical to minimize radiated emissions.
5. Do not suggest routing SW copper under the device.
6. A separate VOUT path should be connected to the upper feedback resistor.
7. Make a Kelvin connection to the GND pin for the feedback path.
8. Voltage feedback loop should be placed away from the high-voltage switching trace, and preferably has ground shield.
9. The trace of the VFB node should be as small as possible to avoid noise coupling.
10. The GND trace between the output capacitor and the GND pin should be as wide as possible to minimize its trace impedance.

10.2 Layout Example

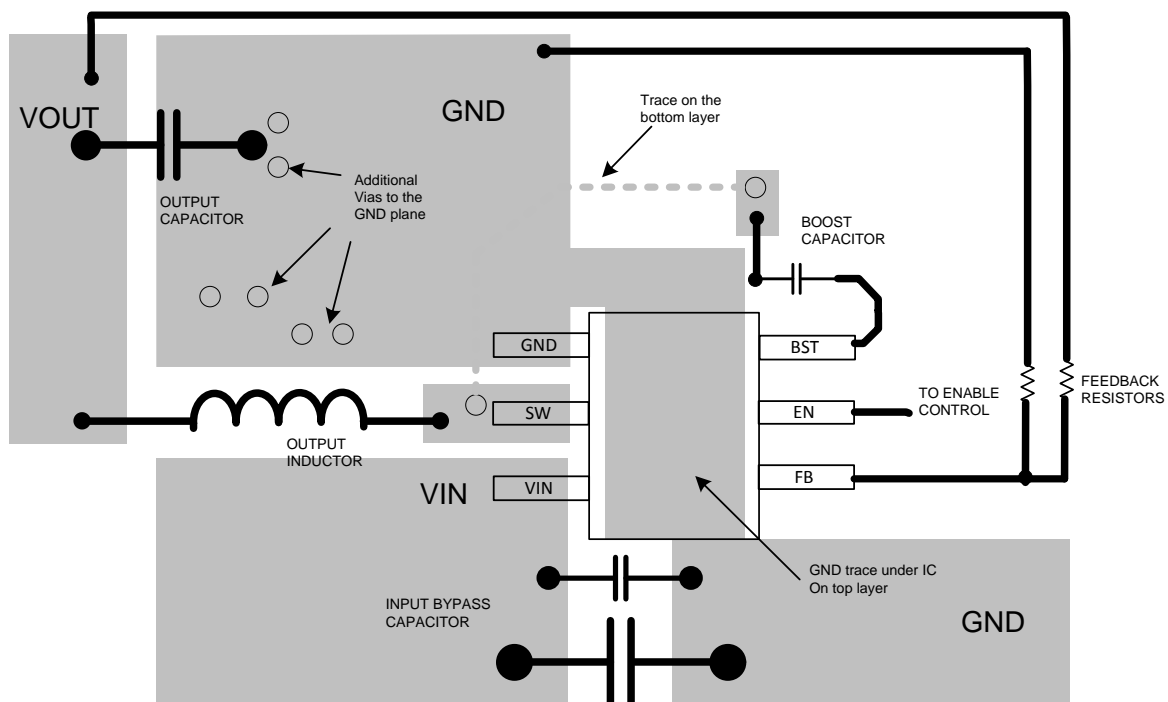

Figure 35. Example Layout

11 Device and Documentation Support

11.1 Receiving Notification of Documentation Updates

To receive notification of documentation updates, navigate to the device product folder on ti.com. In the upper right corner, click on *Alert me* to register and receive a weekly digest of any product information that has changed. For change details, review the revision history included in any revised document.

11.2 Community Resources

The following links connect to TI community resources. Linked contents are provided "AS IS" by the respective contributors. They do not constitute TI specifications and do not necessarily reflect TI's views; see TI's [Terms of Use](#).

TI E2E™ Online Community *TI's Engineer-to-Engineer (E2E) Community*. Created to foster collaboration among engineers. At e2e.ti.com, you can ask questions, share knowledge, explore ideas and help solve problems with fellow engineers.

Design Support *TI's Design Support* Quickly find helpful E2E forums along with design support tools and contact information for technical support.

11.3 Trademarks

D-CAP3, Out-of-Audio, E2E are trademarks of Texas Instruments.
 WEBENCH is a registered trademark of Texas Instruments.
 All other trademarks are the property of their respective owners.

11.4 Electrostatic Discharge Caution



These devices have limited built-in ESD protection. The leads should be shorted together or the device placed in conductive foam during storage or handling to prevent electrostatic damage to the MOS gates.

11.5 Glossary

[SLYZ022](#) — *TI Glossary*.

This glossary lists and explains terms, acronyms, and definitions.

12 Mechanical, Packaging, and Orderable Information

The following pages include mechanical, packaging, and orderable information. This information is the most current data available for the designated devices. This data is subject to change without notice and revision of this document. For browser-based versions of this data sheet, refer to the left-hand navigation.

PACKAGING INFORMATION

| Orderable Device | Status (1) | Package Type | Package Drawing | Pins | Package Qty | Eco Plan (2) | Lead finish/ Ball material (6) | MSL Peak Temp (3) | Op Temp (°C) | Device Marking (4/5) | Samples |
|------------------|---------------|--------------|-----------------|------|-------------|-----------------|--------------------------------------|----------------------|--------------|-------------------------|-------------------------|
| TPS563240DDCR | ACTIVE | SOT-23-THIN | DDC | 6 | 3000 | RoHS & Green | SN | Level-1-260C-UNLIM | -40 to 125 | 3240 | Samples |
| TPS563240DDCT | ACTIVE | SOT-23-THIN | DDC | 6 | 250 | RoHS & Green | SN | Level-1-260C-UNLIM | -40 to 125 | 3240 | Samples |

(1) The marketing status values are defined as follows:

ACTIVE: Product device recommended for new designs.

LIFEBUY: TI has announced that the device will be discontinued, and a lifetime-buy period is in effect.

NRND: Not recommended for new designs. Device is in production to support existing customers, but TI does not recommend using this part in a new design.

PREVIEW: Device has been announced but is not in production. Samples may or may not be available.

OBSOLETE: TI has discontinued the production of the device.

(2) **RoHS:** TI defines "RoHS" to mean semiconductor products that are compliant with the current EU RoHS requirements for all 10 RoHS substances, including the requirement that RoHS substance do not exceed 0.1% by weight in homogeneous materials. Where designed to be soldered at high temperatures, "RoHS" products are suitable for use in specified lead-free processes. TI may reference these types of products as "Pb-Free".

RoHS Exempt: TI defines "RoHS Exempt" to mean products that contain lead but are compliant with EU RoHS pursuant to a specific EU RoHS exemption.

Green: TI defines "Green" to mean the content of Chlorine (Cl) and Bromine (Br) based flame retardants meet JS709B low halogen requirements of <=1000ppm threshold. Antimony trioxide based flame retardants must also meet the <=1000ppm threshold requirement.

(3) MSL, Peak Temp. - The Moisture Sensitivity Level rating according to the JEDEC industry standard classifications, and peak solder temperature.

(4) There may be additional marking, which relates to the logo, the lot trace code information, or the environmental category on the device.

(5) Multiple Device Markings will be inside parentheses. Only one Device Marking contained in parentheses and separated by a "~" will appear on a device. If a line is indented then it is a continuation of the previous line and the two combined represent the entire Device Marking for that device.

(6) Lead finish/Ball material - Orderable Devices may have multiple material finish options. Finish options are separated by a vertical ruled line. Lead finish/Ball material values may wrap to two lines if the finish value exceeds the maximum column width.

Important Information and Disclaimer:The information provided on this page represents TI's knowledge and belief as of the date that it is provided. TI bases its knowledge and belief on information provided by third parties, and makes no representation or warranty as to the accuracy of such information. Efforts are underway to better integrate information from third parties. TI has taken and continues to take reasonable steps to provide representative and accurate information but may not have conducted destructive testing or chemical analysis on incoming materials and chemicals. TI and TI suppliers consider certain information to be proprietary, and thus CAS numbers and other limited information may not be available for release.

In no event shall TI's liability arising out of such information exceed the total purchase price of the TI part(s) at issue in this document sold by TI to Customer on an annual basis.

EXAMPLE BOARD LAYOUT

DDC0006A

SOT-23 - 1.1 max height

SMALL OUTLINE TRANSISTOR

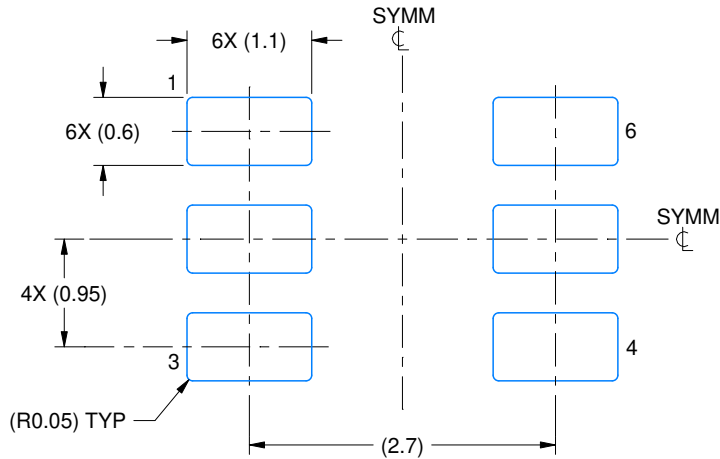

LAND PATTERN EXAMPLE
EXPLODED METAL SHOWN
SCALE:15X

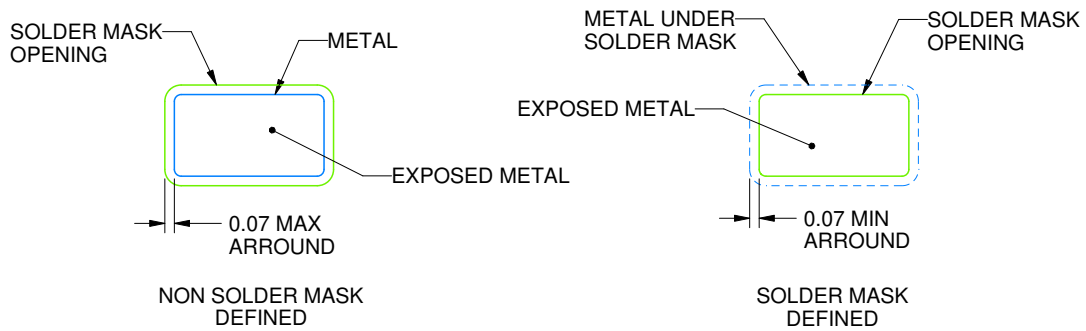

SOLDEMASK DETAILS

4214841/C 04/2022

NOTES: (continued)

- 4. Publication IPC-7351 may have alternate designs.
- 5. Solder mask tolerances between and around signal pads can vary based on board fabrication site.

EXAMPLE STENCIL DESIGN

DDC0006A

SOT-23 - 1.1 max height

SMALL OUTLINE TRANSISTOR

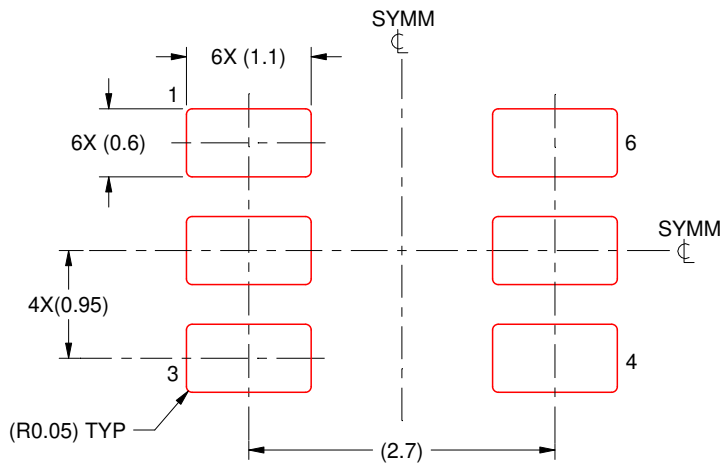

SOLDER PASTE EXAMPLE
BASED ON 0.125 THICK STENCIL
SCALE:15X

4214841/C 04/2022

NOTES: (continued)

6. Laser cutting apertures with trapezoidal walls and rounded corners may offer better paste release. IPC-7525 may have alternate design recommendations.
7. Board assembly site may have different recommendations for stencil design.

IMPORTANT NOTICE AND DISCLAIMER

TI PROVIDES TECHNICAL AND RELIABILITY DATA (INCLUDING DATA SHEETS), DESIGN RESOURCES (INCLUDING REFERENCE DESIGNS), APPLICATION OR OTHER DESIGN ADVICE, WEB TOOLS, SAFETY INFORMATION, AND OTHER RESOURCES "AS IS" AND WITH ALL FAULTS, AND DISCLAIMS ALL WARRANTIES, EXPRESS AND IMPLIED, INCLUDING WITHOUT LIMITATION ANY IMPLIED WARRANTIES OF MERCHANTABILITY, FITNESS FOR A PARTICULAR PURPOSE OR NON-INFRINGEMENT OF THIRD PARTY INTELLECTUAL PROPERTY RIGHTS.

These resources are intended for skilled developers designing with TI products. You are solely responsible for (1) selecting the appropriate TI products for your application, (2) designing, validating and testing your application, and (3) ensuring your application meets applicable standards, and any other safety, security, regulatory or other requirements.

These resources are subject to change without notice. TI grants you permission to use these resources only for development of an application that uses the TI products described in the resource. Other reproduction and display of these resources is prohibited. No license is granted to any other TI intellectual property right or to any third party intellectual property right. TI disclaims responsibility for, and you will fully indemnify TI and its representatives against, any claims, damages, costs, losses, and liabilities arising out of your use of these resources.

TI's products are provided subject to [TI's Terms of Sale](#) or other applicable terms available either on ti.com or provided in conjunction with such TI products. TI's provision of these resources does not expand or otherwise alter TI's applicable warranties or warranty disclaimers for TI products.

TI objects to and rejects any additional or different terms you may have proposed.

Mailing Address: Texas Instruments, Post Office Box 655303, Dallas, Texas 75265
Copyright © 2022, Texas Instruments Incorporated