

# HLMA-Qx00, HLMA-Px00, HLMT-Px00, and HLMT-Qx00

## Subminiature High Performance AlInGaP LED Lamps

### Sun Power Series

HLMA-PF00, HLMA-PG00, HLMA-PH00, HLMA-PL00, HLMA-QF00, HLMA-QG00, HLMA-QH00, HLMA-QL00, HLMT-PG00, HLMT-PH00, HLMT-PL00, HLMT-QG00, HLMT-QH00, HLMT-QL00

---

## Description

### Flat Top Package

The HLMX-PXXX flat top lamps use an untinted, nondiffused, truncated lens to provide a wide radiation pattern that is necessary for use in backlighting applications. The flat top lamps are also ideal for use as emitters in light pipe applications.

### Dome Packages

The HLMX-QXXX dome lamps use an untinted, nondiffused lens to provide a high luminous intensity within a narrow radiation pattern.

### Lead Configurations

All of these devices are made by encapsulating LED chips on axial lead frames to form molded epoxy subminiature lamp packages. A variety of package configuration options are available. These include special surface mount lead configurations, gull wing, yoke lead, or Z-bend. Right angle lead bends at 2.54 mm (0.100 in.) and 5.08 mm (0.200 in.) center spacing are available for through hole mounting. For more information, refer to the *Standard SMT and Through Hole Lead Bend Options for Subminiature LED Lamps Data Sheet*.

## Features

- Subminiature flat top package  
Ideal for backlighting and light piping applications
- Subminiature dome package  
Nondiffused dome for high brightness
- Wide range of drive currents
- Colors:
  - 590-nm Amber
  - 605-nm Orange
  - 615-nm Reddish-Orange
  - 622/626-nm Red
  - 635-nm Red
- Ideal for space-limited applications
- Axial leads
- Available with lead configurations for surface mount and through hole PC board mounting

## Technology

These subminiature solid state lamps use one of the two newly developed aluminum indium gallium phosphide (AlInGaP) LED technologies. The HLMT-devices are especially effective in very bright ambient lighting conditions. The colors 590-nm amber, 605-nm orange, 615-nm reddish-orange, 622/626-nm red, and 635-nm red are available with viewing angles of 15° for the domed devices and 125° for the flat top devices.

## Device Selection Guide

Part Number	$\lambda_d$ (nm)	Typ. $I_V$ (mcd)	Package Description	Viewing Angle $2\theta_{1/2}$	Package Outline
HLMA-QL00	590	500	Domed, Nondiffused, Untinted	15°	B
HLMT-QL00	590	1000			
HLMA-QJ00	605	500			
HLMA-QH00	615	500			
HLMT-QH00	615	800			
HLMA-QG00	626	500			
HLMT-QG00	622	1000			
HLMA-QF00	635	500			
HLMA-PL00	590	75	Flat Top, Nondiffused, Untinted	125°	A
HLMT-PL00	590	150			
HLMA-PJ00	605	75			
HLMA-PH00	615	75			
HLMT-PH00	615	120			
HLMA-PG00	626	75			
HLMT-PG00	622	150			
HLMA-PF00	635	75			

## Absolute Maximum Ratings at $T_A = 25^\circ\text{C}$

Parameter	HLMA-xxxx	HLMT-xxxx	Units
Peak Forward Current <sup>a</sup>	100	100	mA
Average Forward Current ( $I_{PEAK} = 100 \text{ mA}$ ) <sup>a, b</sup>	30	30	mA
DC Forward Current <sup>c, d, e</sup>	50	50	mA
Power Dissipation	120	130	mW
Reverse Voltage ( $I_R = 100 \mu\text{A}$ )	5		V
Transient Forward Current (10 $\mu\text{s}$ Pulse) <sup>f</sup>	500		mA
Operating Temperature Range	-40 to +100		°C
Storage Temperature Range	-55 to +100		°C
LED Junction Temperature	110		°C
Lead Soldering Temperature (1.6 mm (0.063 in.) from body)	260°C for 5 seconds		
SMT Reflow Soldering Temperature	260°C for 20 seconds		

- See [Figure 7](#) and [Figure 8](#) to establish pulsed operating conditions.
- Maximum  $I_{AVG}$  at  $f = 1 \text{ kHz}$ .
- Derate linearly as shown in [Figure 6](#).
- Drive currents between 10 mA and 30 mA are recommended for best long term performance.
- Operation at currents below 5 mA is not recommended; contact your Broadcom sales representative.
- The transient peak current is the maximum non-recurring peak current these devices can withstand without damaging the LED die and wire bonds. Operation at currents above Absolute Maximum Peak Forward Current is not recommended.

# Part Numbering System

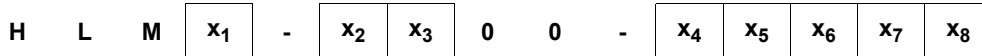

Number	Description	Option	Option Description
X <sub>1</sub>	Technology	A/T	AlInGaP
X <sub>2</sub>	Package Option	Q	Dome
		P	Flat Top
X <sub>3</sub>	Color Option	L	Amber 590 nm
		J	Orange 605 nm
		H	Reddish Orange 615 nm
		G	Red 622/626 nm
		F	Red 635 nm
X <sub>4</sub>	Minimum I <sub>V</sub> Bin Options	Refer to the I <sub>V</sub> Bin table.	
X <sub>5</sub>	Maximum I <sub>V</sub> Bin Options	Refer to the I <sub>V</sub> Bin table.	
X <sub>6</sub>	Color Bin Selection	0	Full Color Bin Distribution
		B	Color Bins 2 and 3
		K	Color Bins 2, 3, and 4
		R	Color Bins 2 and 4
		W	Color Bins 2, 4, 6, and 7
		X	Color Bins 4, 6, and 7
X <sub>7</sub> , X <sub>8</sub>		00	Straight Leads, Bulk Packaging, Quantity of 500 parts
		11	Gull Wing Bend, Tape and Reel – 7 in. Reel
		12	Gull Wing Bend, Bulk
		14	Gull Wing Bend, Tape and Reel – 13 in. Reel
		21	Yoke Bend, Tape and Reel – 7 in. Reel
		22	Yoke Bend, Bulk
		24	Yoke Bend, Tape and Reel – 13 in. Reel
		31	Z-Bend, Tape and Reel – 7 in. Reel
		32	Z-Bend, Bulk
34	Z-Bend, Tape and Reel – 13 in. Reel		

# Package Dimensions

## A – Flat Top Lamps

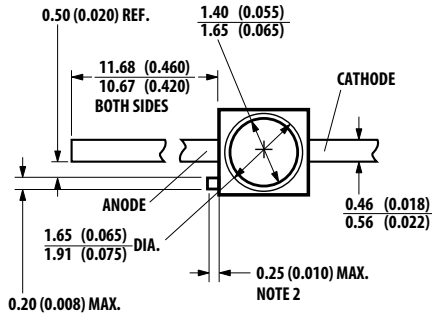

## B – Domed Lamps, Diffused and Nondiffused

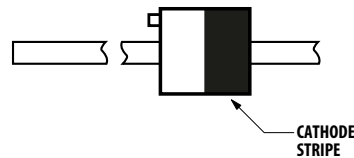
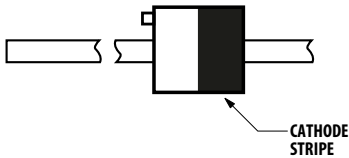
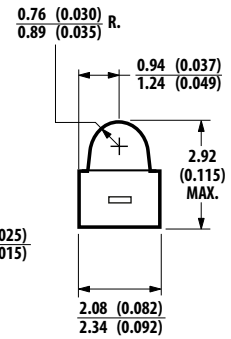
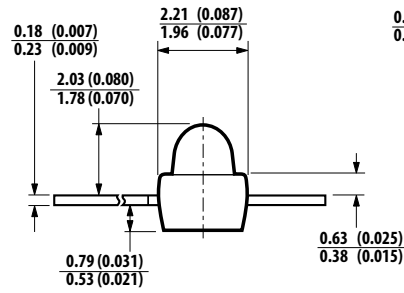
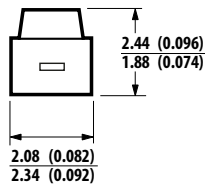
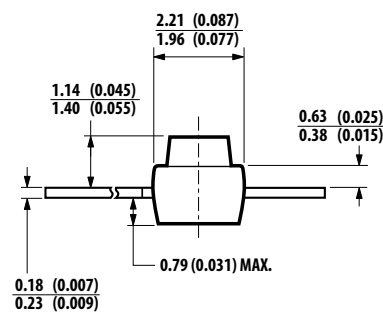
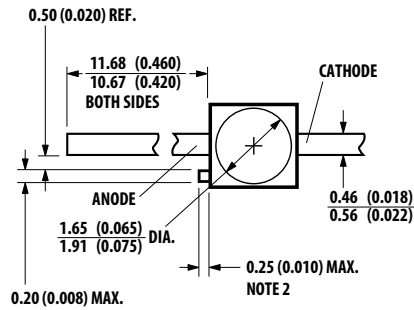

NOTES:  
 1. ALL DIMENSIONS ARE IN MILLIMETRES (INCHES).  
 2. PROTRUDING SUPPORT TAB IS CONNECTED TO CATHODE LEAD.

## Package Mounting

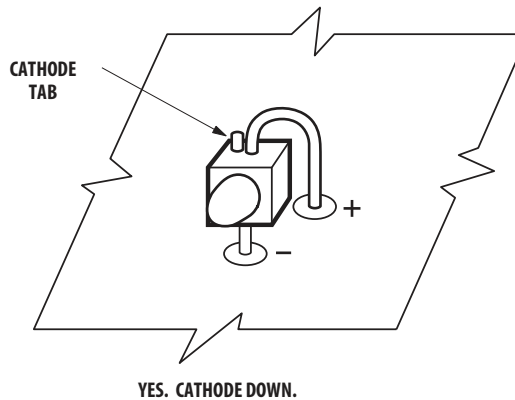
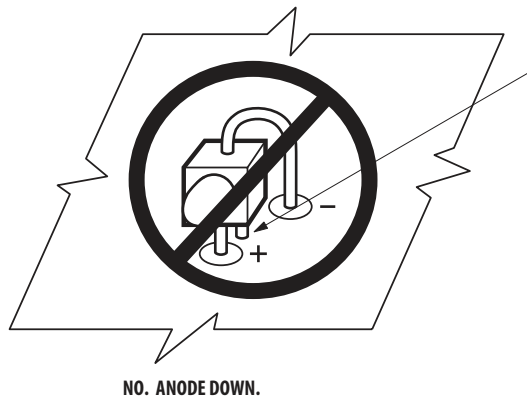

Proper right angle mounting to a PC board to prevent protruding cathode tab from shorting to anode connection.

## Optical Characteristics at $T_A = 25^\circ\text{C}$

Part Number	Luminous Intensity $I_v$ (mcd) at 20 mA <sup>a</sup>			Total Flux $\Phi_v$ (min) at 20 mA <sup>b</sup>	Peak Wavelength $\lambda_{\text{peak}}$ (nm)	Color, Dominate Wavelength $\lambda_d$ <sup>c</sup> (nm)	Viewing Angle $2\theta_{1/2}$ Degrees <sup>d</sup>	Luminous Efficacy $\eta_v$ <sup>e</sup> (lm/w)
	Min.	Typ.	Max.	Typ.	Typ.	Typ.	Typ.	Typ.
HLMA-QL00-S00xx	160	500	—	250	592	590	15	480
HLMA-QL00-TU0xx	250	—	800	250	592	590	15	480
HLMA-QL00-TUKxx	250	—	800	250	592	590	15	480
HLMA-QL00-TVBxx	250	—	1250	250	592	590	15	480
HLMA-QL00-TVKxx	250	—	1250	250	592	590	15	480
HLMA-QL00-UV0xx	400	—	1250	250	592	590	15	480
HLMA-QL00-UVRxx	400	—	1250	250	592	590	15	480
HLMA-QL00-UWBxx	400	—	2000	250	592	590	15	480
HLMT-QL00-T00xx	250	1000	—	800	592	590	15	480
HLMA-QJ00-S00xx	160	500	—	250	609	605	15	370
HLMA-QH00-S00xx	160	500	—	250	621	615	15	263
HLMA-QH00-T00xx	250	500	—	250	621	615	15	263
HLMA-QH00-UW0xx	400	—	2000	250	621	615	15	263
HLMT-QH00-T00xx	250	500	—	800	621	615	15	263
HLMT-QH00-WX0xx	1000	—	3200	800	621	615	15	263
HLMA-QG00-S00xx	160	500	—	250	635	626	15	150
HLMA-QG00-TV0xx	250	—	1250	250	635	626	15	150
HLMT-QG00-T00xx	250	1000	—	800	635	622	15	150
HLMA-QF00-S00xx	160	500	—	250	650	635	15	110
HLMA-PL00-N00xx	25	75	—	250	592	590	125	480
HLMA-PL00-PRRxx	40	—	200	250	592	590	125	480
HLMA-PL00-PRXxx	40	—	200	250	592	590	125	480
HLMA-PL00-QRXxx	63	—	200	250	592	590	125	480
HLMT-PL00-P0Wxx	40	150	—	800	592	590	125	480
HLMA-PJ00-N00xx	25	75	—	250	609	605	125	370
HLMA-PH00-N00xx	25	75	—	250	621	615	125	263
HLMT-PH00-P00xx	40	120	—	800	621	615	125	263
HLMA-PG00-N00xx	25	75	—	250	635	626	125	150
HLMT-PG00-P00xx	40	150	—	800	635	622	125	150
HLMA-PF00-N00xx	25	75	—	250	640	635	125	110

- The luminous intensity,  $I_v$ , is measured at the mechanical axis of the lamp package. The actual peak of the spatial radiation pattern may not be aligned with this axis.
- $\Phi_v$  is the total luminous flux output as measured with an integrating sphere.
- The dominant wavelength,  $\lambda_d$ , is derived from the CIE Chromaticity Diagram and represents the color of the device.
- $\theta_{1/2}$  is the off-axis angle where the luminous intensity is  $1/2$  the peak intensity.
- Radiant intensity,  $I_e$ , in watts/steradian, may be calculated from the equation  $I_e = I_v/\eta_v$ , where  $I_v$  is the luminous intensity in candelas and  $\eta_v$  is the luminous efficacy in lumens/watt.

# Electrical Characteristics at $T_A = 25^\circ\text{C}$

Part Number	Forward Voltage $V_F$ (Volts) at $I_F = 20\text{ mA}$		Reverse Breakdown Voltage $V_R$ (Volts) at $I_R = 100\ \mu\text{A}$		Thermal Resistance $R_{\theta\text{J-PIN}}$ ( $^\circ\text{C/W}$ )
	Typ.	Max.	Min.	Typ.	Typ.
HLMA-Qx00	1.9	2.4	5	25	170
HLMT-Qx00	2.0	2.6	5	20	170
HLMA-Px00	1.9	2.4	5	25	170
HLMT-Px00	2.0	2.6	5	20	170

Figure 1: Relative Intensity vs. Wavelength

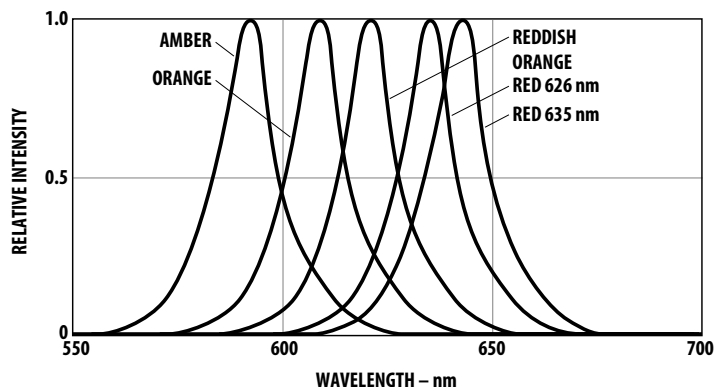

Figure 2: Forward Current vs. Forward Voltage, HLMA-xxxx

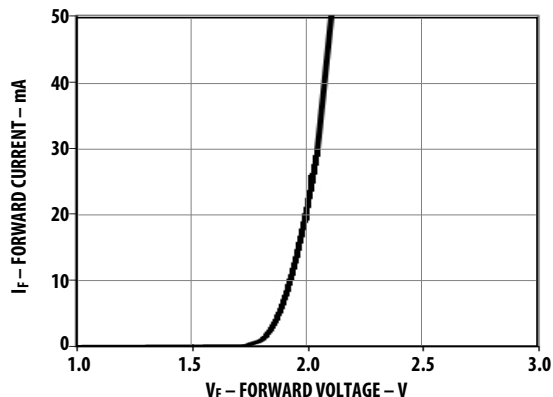

Figure 3: Forward Current vs. Forward Voltage, HLMT-xxxx

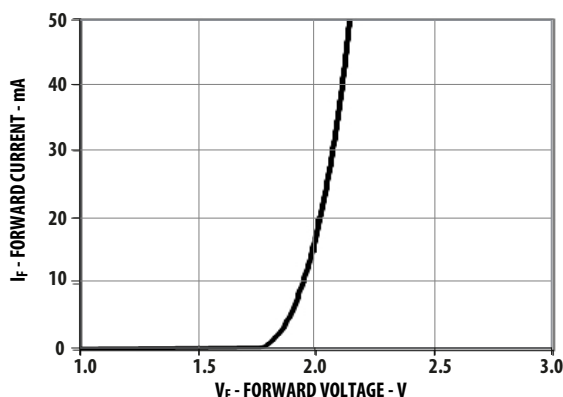

Figure 4: Relative Luminous Intensity vs. DC Forward Current, HLMA-xxxx

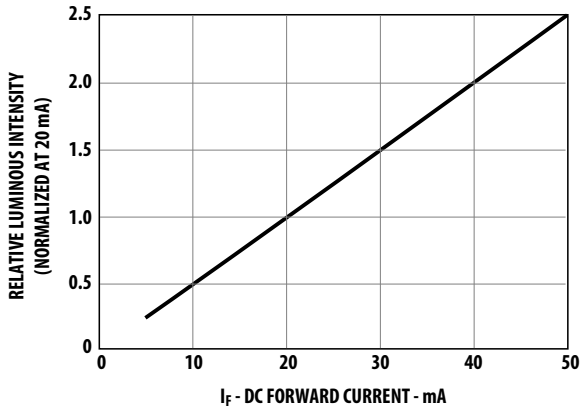

Figure 5: Relative Luminous Intensity vs. DC Forward Current, HLMT-xxxx

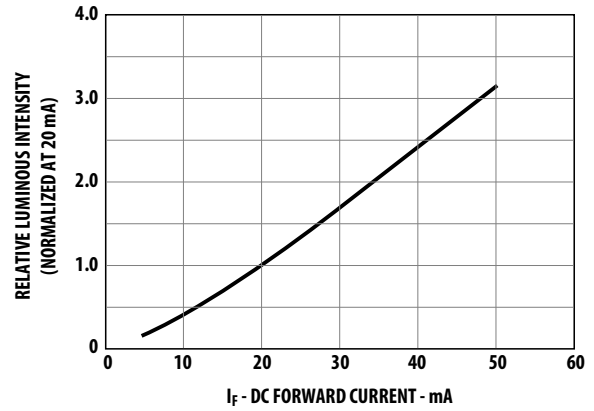

Figure 6: Maximum Forward Current vs. Ambient Temperature

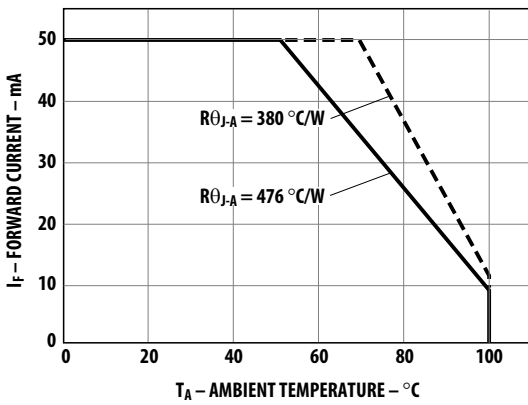

Figure 7: Maximum Average Current vs. Peak Forward Current, HLMA-xxxx

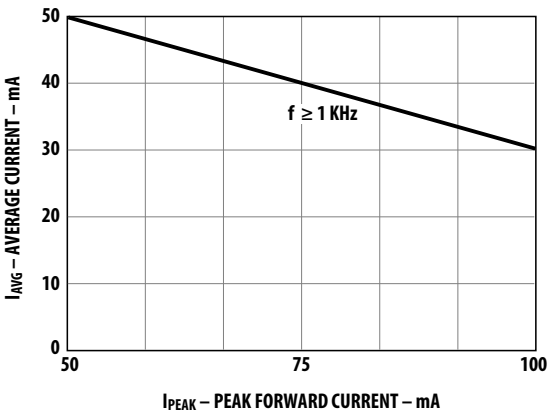

Figure 8: Maximum Average Current vs. Peak Forward Current, HLMT-xxxx

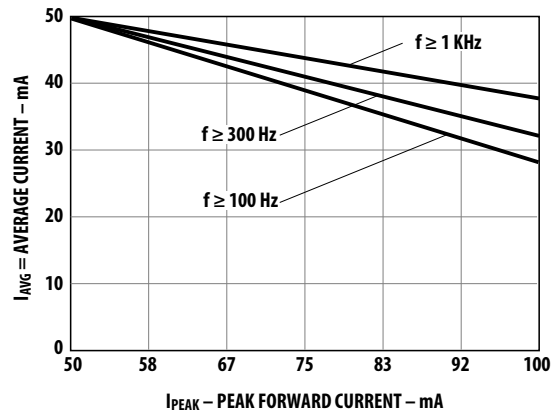

Figure 9: Relative Luminous Intensity vs. Angular Displacement for 15° Device

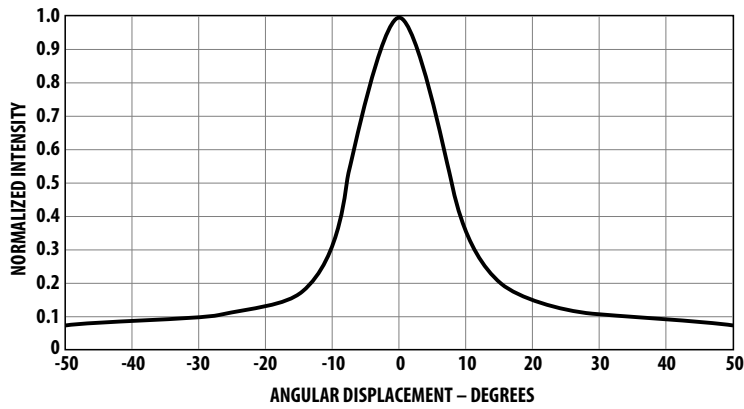
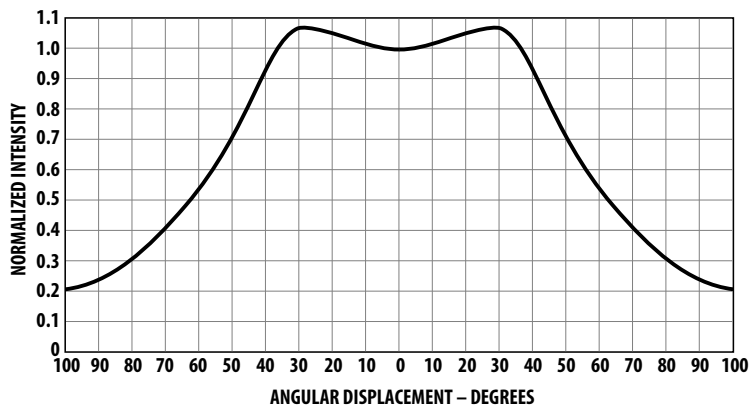

Figure 10: Relative Luminous Intensity vs. Angular Displacement for 125° Device



### Intensity Bin Limits

Bin	Min.	Max.
N	25	50
P	40	80
Q	63	125
R	100	200
S	160	320
T	250	500
U	400	800
V	630	1250
W	1000	2000
X	1600	3200
Y	2500	5000

### Color Bin Limits

Package	Bin	Min.	Max.
Yellow	0	Full Distribution	
	3	584.0	587.5
	2	586.5	590.0
	4	589.0	592.5
	6	591.5	595.0
	7	594.0	597.5
Orange	0	Full Distribution	
	2	599.0	602.5
	3	601.5	604.0
	4	603.8	608.2
	5	606.8	611.2



## Mechanical Option Matrix

Mechanical Option Code	Definition
00	Straight Leads, Bulk Packaging, Quantity of 500 Parts
11	Gull Wing Leads, 12 mm Tape on 7 in. Diameter Reel, 1500 Parts per Reel
12	Gull Wing Leads, Bulk Packaging, Quantity of 500 Parts
14	Gull Wing Leads, 12 mm Tape on 13 in. Diameter Reel, 6000 Parts per Reel
21	Yoke Leads, 12 mm Tape on 7 in. Diameter Reel, 1500 Parts per Reel
22	Yoke Leads, Bulk Packaging, Quantity of 500 Parts
24	Yoke Leads, 12 mm Tape on 13 in. Diameter Reel, 6000 Parts per Reel
31	Z-Bend Leads, 12 mm Tape on 7 in. Diameter Reel, 1500 Parts per Reel
32	Z-Bend Leads, Bulk Packaging, Quantity of 500 Parts
34	Z-Bend Leads, 12 mm Tape on 13 in. Diameter Reel, 6000 Parts per Reel

**NOTE:** All categories are established for classification of products. Products may not be available in all categories. Contact your local Broadcom representative for further clarification and information.

Broadcom, the pulse logo, Connecting everything, Avago Technologies, Avago, and the A logo are among the trademarks of Broadcom and/or its affiliates in the United States, certain other countries, and/or the EU.

Copyright © 2011–2020 Broadcom. All Rights Reserved.

The term “Broadcom” refers to Broadcom Inc. and/or its subsidiaries. For more information, please visit [www.broadcom.com](http://www.broadcom.com).

Broadcom reserves the right to make changes without further notice to any products or data herein to improve reliability, function, or design. Information furnished by Broadcom is believed to be accurate and reliable. However, Broadcom does not assume any liability arising out of the application or use of this information, nor the application or use of any product or circuit described herein, neither does it convey any license under its patent rights nor the rights of others.