



Micro Commercial Components

Micro Commercial Components
20736 Marilla Street Chatsworth
CA 91311
Phone: (818) 701-4933
Fax: (818) 701-4939

GPA801DT thru GPA807DT

Features

- Halogen free available upon request by adding suffix "-HF"
- Low Forward Voltage Drop
- High Current Capability
- High Reliability
- Lead Free Finish/RoHS Compliant(Note 1)("P" Suffix designates Compliant. See ordering information)
- Epoxy meets UL 94 V-0 flammability rating
- Moisture Sensitivity Level 1

Maximum Ratings

- Operating Temperature: -65°C to +150°C
- Storage Temperature: -65°C to +150°C
- Maximum Thermal Resistance; 2.5°C/W Junction To Case

MCC Part Number	Device Marking	Maximum Recurrent Peak Reverse Voltage	Maximum RMS Voltage	Maximum DC Blocking Voltage
GPA801DT	GPA801DT	50V	35V	50V
GPA802DT	GPA802DT	100V	70V	100V
GPA803DT	GPA803DT	200V	140V	200V
GPA804DT	GPA804DT	400V	280V	400V
GPA805DT	GPA805DT	600V	420V	600V
GPA806DT	GPA806DT	800V	560V	800V
GPA807DT	GPA807DT	1000V	700V	1000V

Electrical Characteristics @ 25°C Unless Otherwise Specified

Average Forward Current	$I_{F(AV)}$	8A	$T_C = 100^\circ\text{C}$
Peak Forward Surge Current	I_{FSM}	150A	8.3ms, half sine
Maximum Instantaneous Forward Voltage	V_F	1.1V	$I_F = 8A;$ $T_J = 25^\circ\text{C}$
Maximum DC Reverse Current At Rated DC Blocking Voltage	I_R	5uA	$T_C = 25^\circ\text{C}$
Typical Junction Capacitance	C_J	50pF	Measured at 1.0MHz, $V_R=4.0V$

Note: 1. High Temperature Solder Exemptions Applied, see EU Directive Annex 7.

8 Amp Glass Passivated Rectifier

D²-PACK

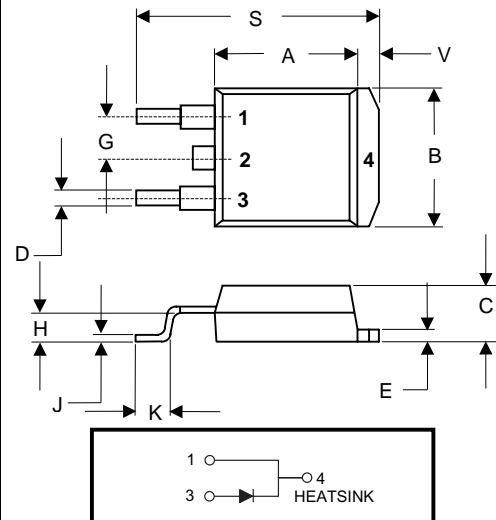

DIM	DIMENSIONS				NOTE
	INCHES		MM		
A	.320	.359	8.13	9.14	
B	.380	.411	9.65	10.45	
C	.160	.190	4.06	4.83	
D	.020	.035	0.51	0.89	
E	.045	.055	1.14	1.40	
G	.095	.105	2.41	2.67	
H	.096	.120	2.43	3.03	
J	.014	.021	0.35	0.53	
K	.090	.110	2.29	2.79	
S	.575	.625	14.60	15.80	
V	.045	.055	1.14	1.40	

SUGGESTED SOLDER PAD LAYOUT

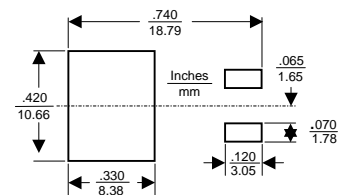

GPA801DT THRU GPA807DT

RATINGS AND CHARACTERISTIC CURVES

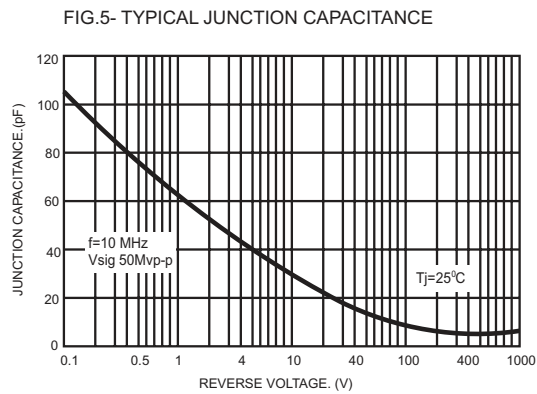
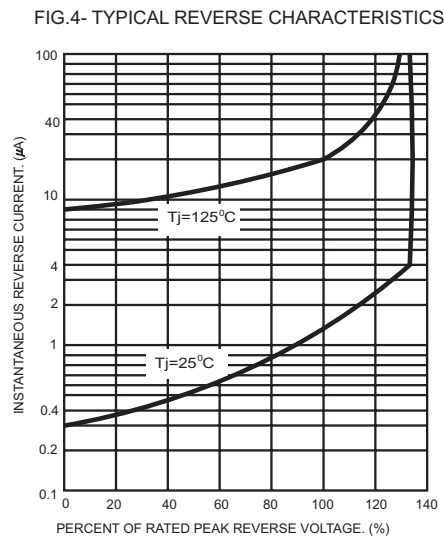
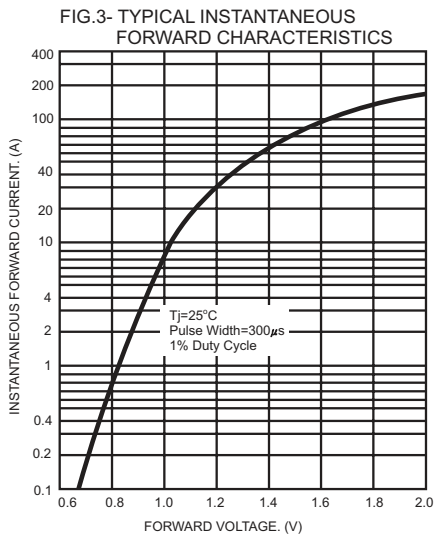
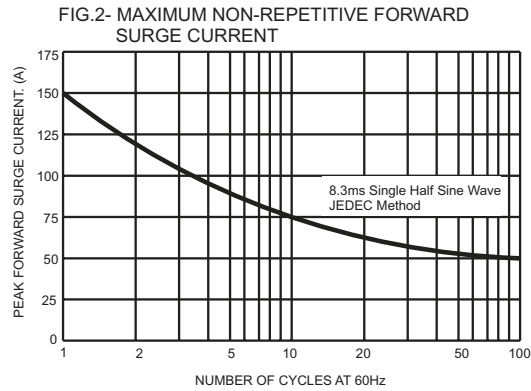
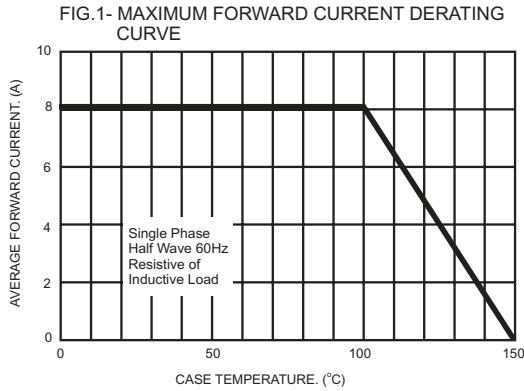



Micro Commercial Components

Ordering Information :

Device	Packing
Part Number-BP	Tube: 1Kpcs/Box

Note : Adding "-HF" suffix for halogen free, eg. Part Number-BP-HF

IMPORTANT NOTICE

Micro Commercial Components Corp. reserves the right to make changes without further notice to any product herein to make corrections, modifications , enhancements , improvements , or other changes . **Micro Commercial Components Corp .** does not assume any liability arising out of the application or use of any product described herein; neither does it convey any license under its patent rights ,nor the rights of others . The user of products in such applications shall assume all risks of such use and will agree to hold **Micro Commercial Components Corp .** and all the companies whose products are represented on our website, harmless against all damages.

LIFE SUPPORT

MCC's products are not authorized for use as critical components in life support devices or systems without the express written approval of Micro Commercial Components Corporation.

CUSTOMER AWARENESS

Counterfeiting of semiconductor parts is a growing problem in the industry. Micro Commercial Components (MCC) is taking strong measures to protect ourselves and our customers from the proliferation of counterfeit parts. MCC strongly encourages customers to purchase MCC parts either directly from MCC or from Authorized MCC Distributors who are listed by country on our web page cited below. Products customers buy either from MCC directly or from Authorized MCC Distributors are genuine parts, have full traceability, meet MCC's quality standards for handling and storage. **MCC will not provide any warranty coverage or other assistance for parts bought from Unauthorized Sources.** MCC is committed to combat this global problem and encourage our customers to do their part in stopping this practice by buying direct or from authorized distributors.

www.mccsemi.com