

3610RL (92[□] x 25^L)



EMINEBEA.COM

General Specifications

Motor Protection:

Automatic Restoration/Reverse
Connection Prevention

Insulation Resistance: 10M Ω or over with a DC500V Megger

Dielectric Withstand Voltage: AC 700V 1s

Allowable Ambient Temperature Range:

B50 Class: -10°C ~ +50°C (Operating)
B10~B40 Class: -10°C ~ +70°C (Operating)
All Class: -40°C ~ +70°C (Storage)
(non-condensing environment)

Expected Life

Failure Rate: 10%

25°C 60,000 Hours (F00)

Characteristic Curves

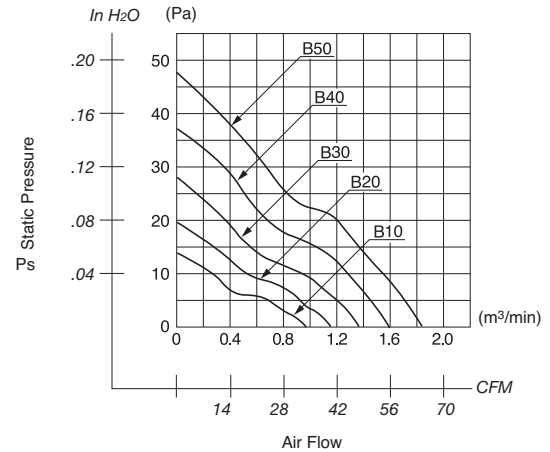

Outline

Units: $\frac{\text{inch}}{\text{mm}}$

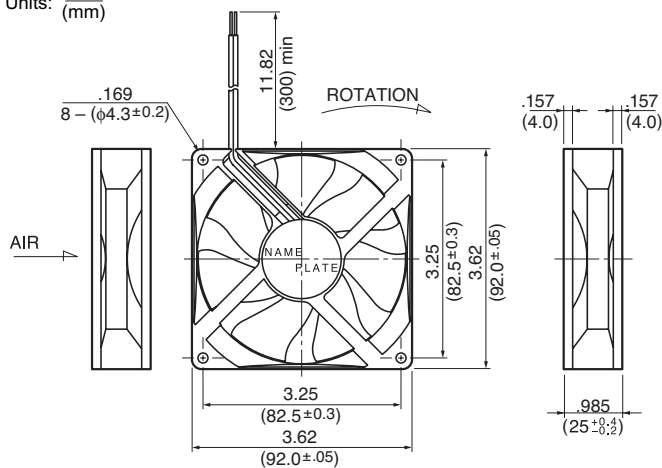

Panel Cut-outs

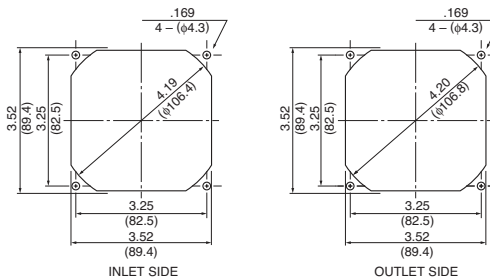

Material

Casing : Plastic (Black) 94V-0
Impeller : Plastic (Black) 94V-0
Bearing : Ball Bearing
Lead Wire : UL1007, AWG24, +Red, -Black

Specifications

MODEL	Product No.	Rated Voltage	Operating Voltage	Current	Input Power	Speed	Max. Air Flow		Max. Static Pressure		Noise	Mass
		(V)	(V)	(A) ^{*1}	(W) ^{*1}	(min ⁻¹) ^{*1}	CFM ^{*1}	(m ³ /min) ^{*1}	in H ₂ O	(Pa) ^{*1}	(dB) ^{*1}	(g)
3610RL-04W-B10-	X00	12	6.0 ~ 13.8	0.09	1.08	1700	34.60	0.98	.05	14.4	22.0	85
3610RL-04W-B20-	X00	12	6.0 ~ 13.8	0.14	1.68	2000	41.31	1.17	.08	20.0	27.0	85
3610RL-04W-B30-	X00	12	6.0 ~ 13.8	0.20	2.40	2350	48.73	1.38	.11	27.6	32.0	85
3610RL-04W-B40-	X00	12	6.0 ~ 13.8	0.28	3.36	2750	56.85	1.61	.15	37.5	35.5	85
3610RL-04W-B50-	X00	12	6.0 ~ 13.2	0.46	5.52	3150	64.97	1.84	.19	47.8	39.5	85
3610RL-05W-B10-	X00	24	10.0 ~ 27.6	0.05	1.20	1700	34.60	0.98	.05	14.4	22.0	85
3610RL-05W-B20-	X00	24	10.0 ~ 27.6	0.07	1.68	2000	41.31	1.17	.08	20.0	27.0	85
3610RL-05W-B30-	X00	24	10.0 ~ 27.6	0.10	2.40	2350	48.73	1.38	.11	27.6	32.0	85
3610RL-05W-B40-	X00	24	10.0 ~ 27.6	0.17	4.08	2750	56.85	1.61	.15	37.5	35.3	85
3610RL-05W-B50-	X00	24	10.0 ~ 26.4	0.25	6.00	3150	64.97	1.84	.19	47.8	39.5	85

Rotation: Clockwise

Airflow Outlet: Air Out Over Struts

*1: Average Values in Free Air