

Customer Information Sheet

NOTES:
 1. MATES WITH M60-614XX45 OR M60-616XX45 TO GIVE BOARD-TO-BOARD HEIGHTS OF 7mm AND 9mm RESPECTIVELY
 2. ALL TOLERANCES ARE ± 0.30 UNLESS OTHERWISE STATED.

SPECIFICATIONS:
 MATERIAL:
 MOULDING = LCP, UL94V-0
 CONTACTS = PHOSPHOR BRONZE.
 FINISH:
 CONTACTS:
 0.05 μ MIN GOLD OVER 1.27 μ MIN NICKEL
 0.5 μ MIN GOLD ON CONTACT AREA.
 ELECTRICAL:
 CURRENT RATING = 0.5 AMPS
 VOLTAGE RATING = 100V AC
 DIELECTRIC WITHSTANDING VOLTAGE = 300V AC (1 MINUTE)
 INSULATION RESISTANCE = 100 MEGAOHMS MIN (250V DC)
 CONTACTS RESISTANCE = 40 MILLIOHMS MAX.
 MECHANICAL:
 DURABILITY = 30 CYCLES
 ENVIRONMENTAL:
 TEMPERATURE RANGE = -55°C TO +100°C
 PACKING TUBE = TUBE.

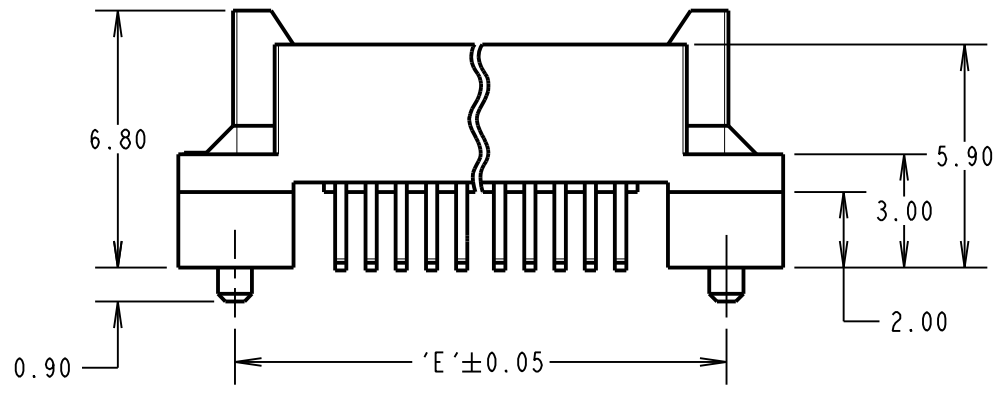
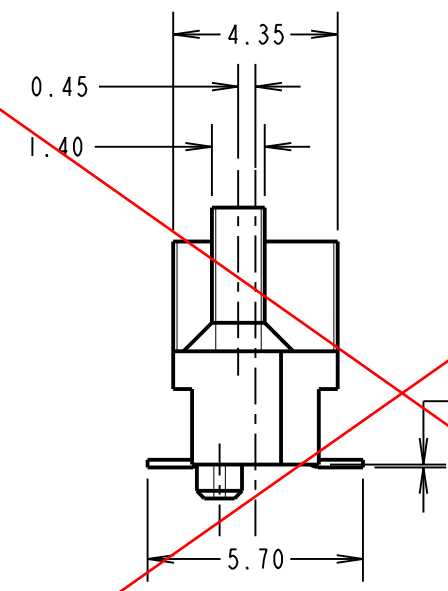
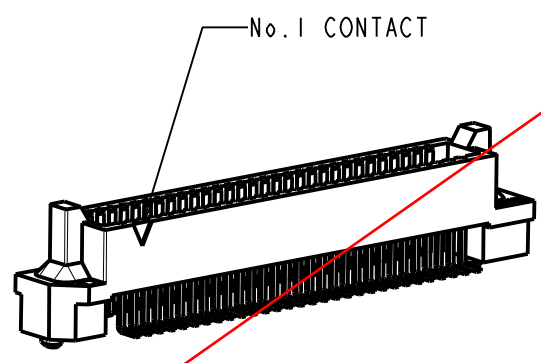
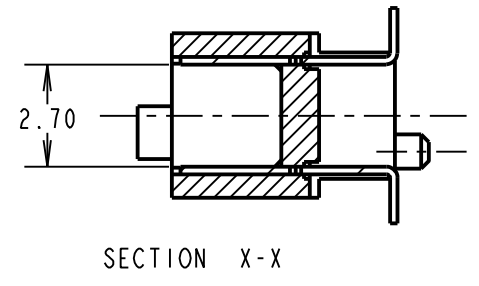
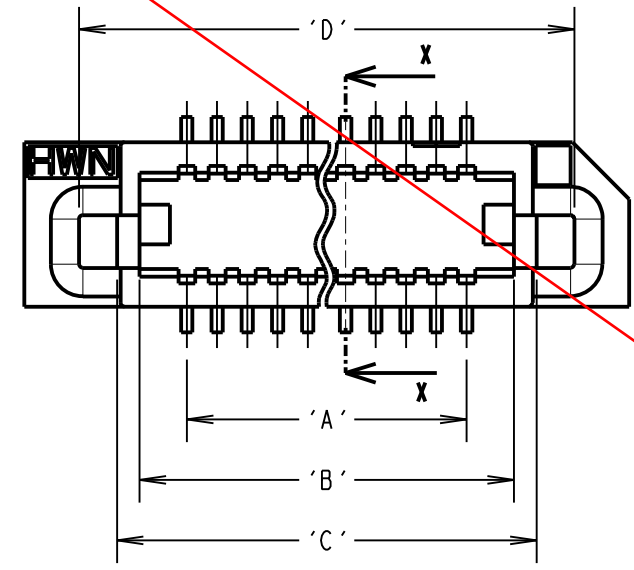

RECOMMENDED PCB LAYOUT

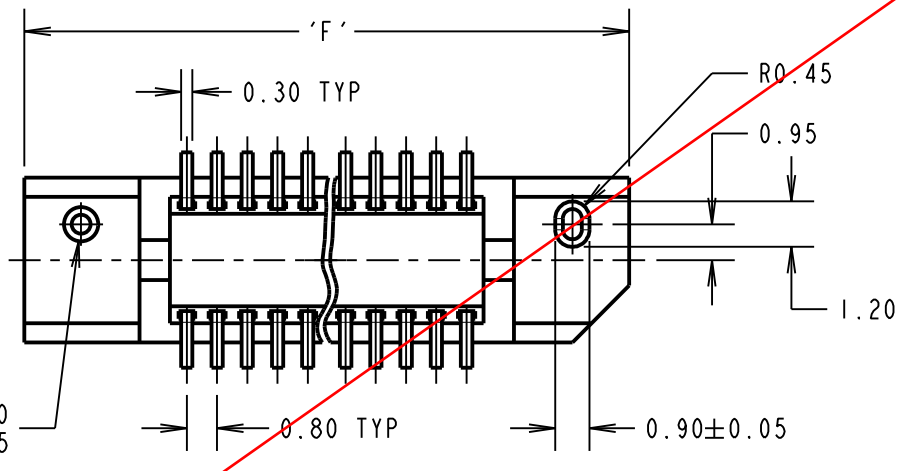
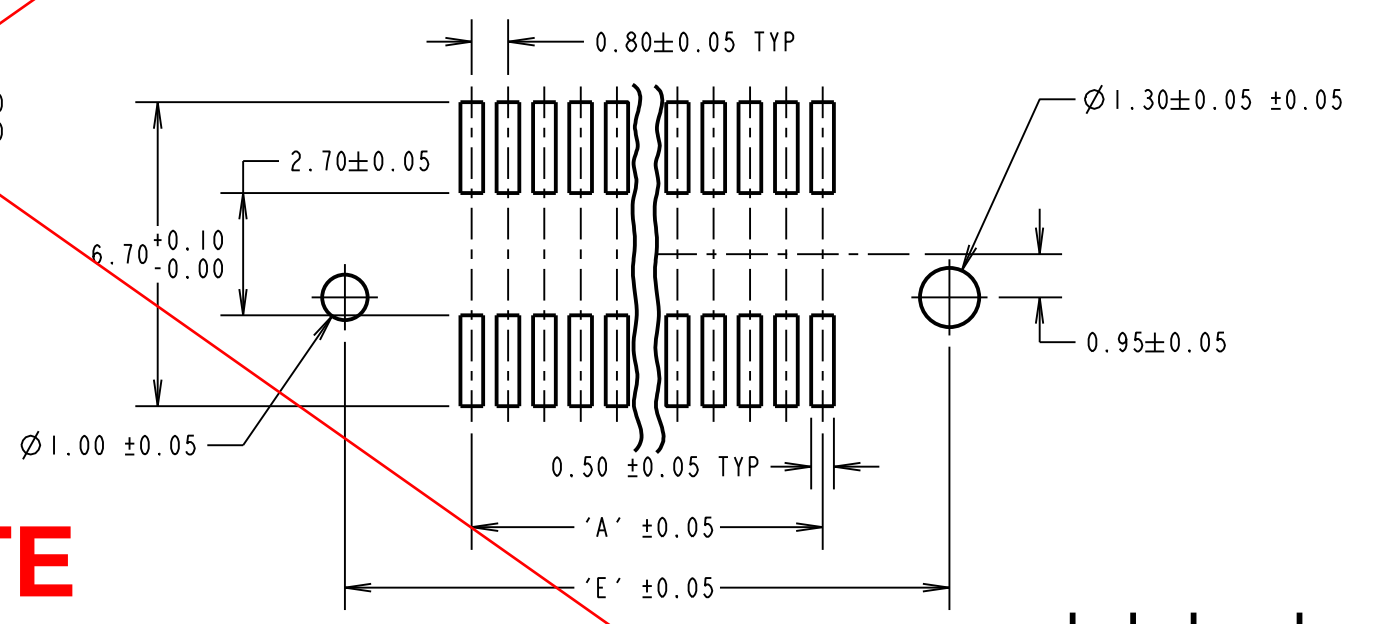

OBSOLETE

ORDER CODE:
M60-606XX45
 No. OF CONTACTS PER ROW
 10, 15, 25

PART No.	No. OF CONTACTS	'A'	'B'	'C'	'D'	'E'	'F'	QTY PER TUBE
M60-6061045	10 + 10	7.2	9.7	10.7	12.9	12.8	15.8	36
M60-6061545	15 + 15	11.2	13.7	14.7	16.9	16.8	19.8	29
M60-6062545	25 + 25	19.2	21.7	22.7	24.9	24.8	27.8	20

MSP	10	04.11.14	12668
NAME	ISS.	DATE	C/NOTE
APPROVED: M.PERREN			
CHECKED: M.G.PLESTED			
DRAWN: M.PERREN			
CUSTOMER REF.:			
ASSEMBLY DRG:			

HARWIN
 www.harwin.com
 technical@harwin.com

THIS DRAWING AND ANY INFORMATION OR DESCRIPTIVE MATTER SET OUT HEREON ARE CONFIDENTIAL AND COPYRIGHT PROPERTY OF THE HARWIN GROUP AND MUST NOT BE DISCLOSED, LOANED, COPIED OR USED FOR MANUFACTURING, TENDERING OR FOR ANY OTHER PURPOSE WITHOUT THEIR WRITTEN PERMISSION.

TOLERANCES
 X = ± 1 mm
 X.X = ± 0.50 mm
 X.XX = ± 0.10 mm
 X.XXX = ± 0.01 mm
 ANGLES = $\pm 5^\circ$
 UNLESS STATED

MATERIAL: SEE ABOVE
 FINISH: SEE ABOVE
 S/AREA: mm²

TITLE:
 0.80mm PITCH SMT SOCKET CONNECTOR (6mm HIGH)
 DRAWING NUMBER:
M60-606XX45