

"18350" LITHIUM-ION BATTERY HOLDERS

THM Leaf Springs

THM Polarized

Solder Lugs*

SMT Leaf Springs

SMT Polarized



1095

1097 (Dual Cell)
Not Shown



1095P

1097P (Dual Cell)
Not Shown

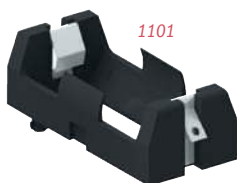

1101

1102 (Dual Cell)
Not Shown

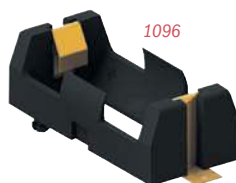

1096

1098 (Dual Cell)
Not Shown



1096P

1098P (Dual Cell)
Not Shown

FEATURES

- Low profile surface mount holder for Cylindrical Lithium and alkaline batteries
- UL 94V-0 heat resistant nylon housing well suited for reflow soldering
- Battery installation and removal does not require tools
- Securely holds battery in place

- Accomodates cells with or without built-in PCB protection circuits
- Polarity clearly marked for orientation
- Polarized holders available for protection against improper battery installation

Operating Temp Range:

-60°F to +290°F (-50°C to +145°C)

APPLICATIONS

- Computer memory, power backup systems
- Digital readers
- Laptop and touch pad computers
- PLC and industrial controls
- Electronic cigarette/vapor industry



PC Battery Clip Available
See Page 11.

THRU HOLE MOUNT

SURFACE MOUNT

SINGLE CELL

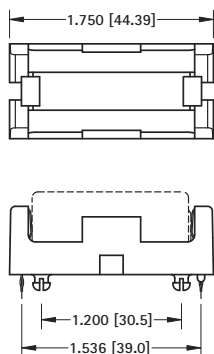
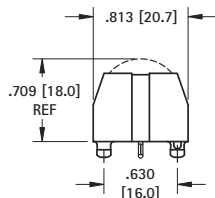
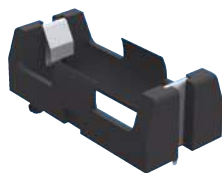

Mounting Detail

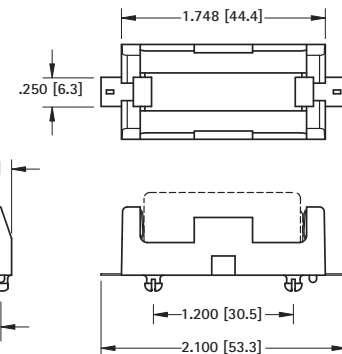
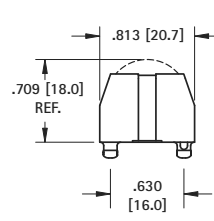
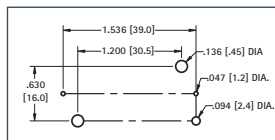

Pad Layout

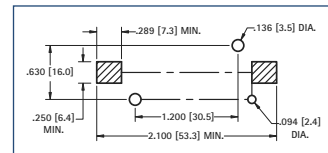

SPECIFICATIONS

Base: High Temp Nylon 46, UL 94V-0
Contacts: .012 (.30) Stainless Steel, Gold Plate (Flash)

CAT. NO. 1096 Leaf Springs

CAT. NO. 1096P Polarized Holder

Packaging Spec's: 50 pieces per tray

SPECIFICATIONS

Base: High Temp Nylon 46, UL 94V-0
Contacts: .012 (.30) Stainless Steel, Tin-Nickel Plate

CAT. NO. 1095 Leaf Springs

CAT. NO. 1095P Polarized Holder

CAT. NO. 1101 Solder Lugs *see image above

Packaging Spec's: 50 pieces per tray

DUAL CELL

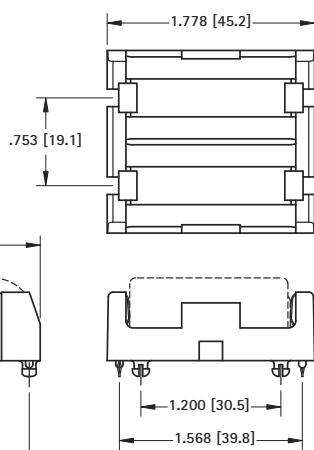
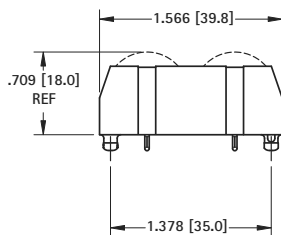
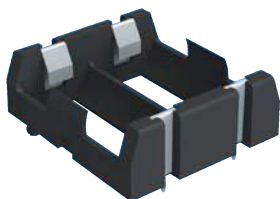

Mounting Detail

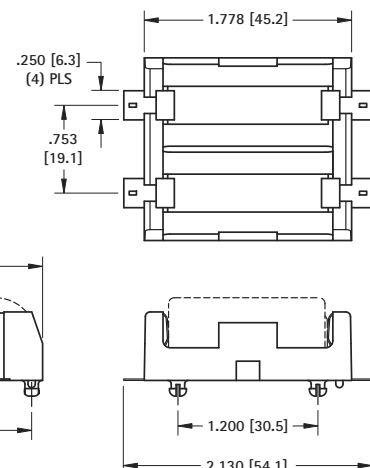
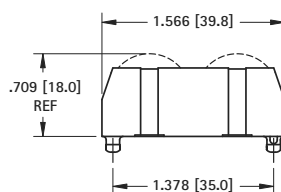
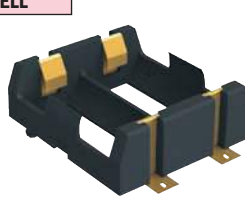
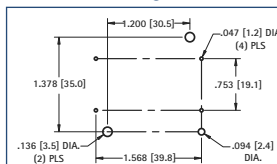

Pad Layout

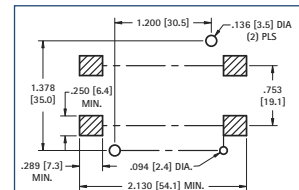

SPECIFICATIONS

Base: High Temp Nylon 46, UL 94V-0
Contacts: .012 (.30) Stainless Steel, Gold Plate (Flash)

CAT. NO. 1098 Leaf Springs

CAT. NO. 1098P Polarized Holder

Packaging Spec's: 25 pieces per tray

SPECIFICATIONS

Base: High Temp Nylon 46, UL 94V-0
Contacts: .012 (.30) Stainless Steel, Tin-Nickel Plate

CAT. NO. 1097 Leaf Springs

CAT. NO. 1097P Polarized Holder

CAT. NO. 1102 Solder Lugs *see image above

Packaging Spec's: 25 pieces per tray

"18350" LITHIUM-ION BATTERY HOLDERS