

300 mA low quiescent current soft-start, low noise voltage regulator

Datasheet - production data

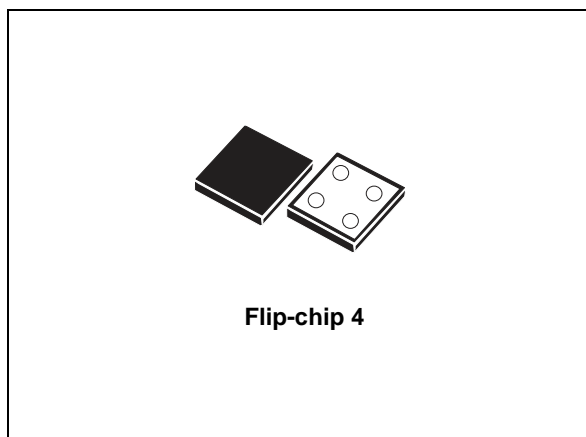

Features

- Input voltage from 1.5 to 5.5 V
- Ultra low dropout voltage (200 mV typ. at 300 mA load)
- Very low quiescent current (20 μ A typ. at no load, 40 μ A typ. at 300 mA load, 1 μ A max. in off mode)
- Very low noise (30 μ V_{RMS} from 1 kHz to 100 kHz at V_{OUT} = 1.8 V)
- Output voltage tolerance: \pm 2.0 % @ 25 °C
- 300 mA guaranteed output current
- Wide range of output voltages available on request: 0.8 V to 4.5 V with 100 mV step
- Logic-controlled electronic shutdown
- Compatible with ceramic capacitor C_{OUT} = 1 μ F
- Internal current and thermal limit
- Flip-chip 4 bumps 0.8 x 0.8 mm pitch 0.4 mm
- Internal soft-start (typ. 100 μ s)
- Temperature range: - 40 °C to 125 °C

Applications

- Mobile phones
- Personal digital assistants (PDAs)
- Cordless phones and similar battery-powered systems
- Digital still cameras.

Description

The LD39030SJ is a low noise voltage regulator that provides 300 mA maximum current from an input voltage in the 1.5 V to 5.5 V range, with a typical dropout voltage of 200 mV. It is stabilized with a ceramic capacitor on the output. The ultra low drop voltage, low quiescent current, and low noise features make it suitable for low power battery-powered applications. Power supply rejection is typically 62 dB at low frequencies and starts to roll off at 10 kHz. An enable logic control function puts the LD39030SJ in shutdown mode allowing a total current consumption lower than 1 μ A. The device also includes a short-circuit constant current limiting and thermal protection.

Table 1. Device summary

| Order codes | Output voltages |
|---------------|-----------------|
| LD39030SJ10R | 1 V |
| LD39030SJ12R | 1.2 V |
| LD39030SJ126R | 1.26 V |
| LD39030SJ28R | 2.8 V |
| LD39030SJ285R | 2.85 V |
| LD39030SJ33R | 3.3 V |

Contents

| | | |
|----|---|----|
| 1 | Block diagram | 3 |
| 2 | Pin configuration | 4 |
| 3 | Typical application | 5 |
| 4 | Maximum ratings | 6 |
| 5 | Electrical characteristics | 7 |
| 6 | Soft-start function | 9 |
| 7 | Typical performance characteristics | 10 |
| 8 | Package mechanical data | 13 |
| 9 | Packaging mechanical data | 15 |
| 10 | Revision history | 17 |



1 Block diagram

Figure 1. Block diagram

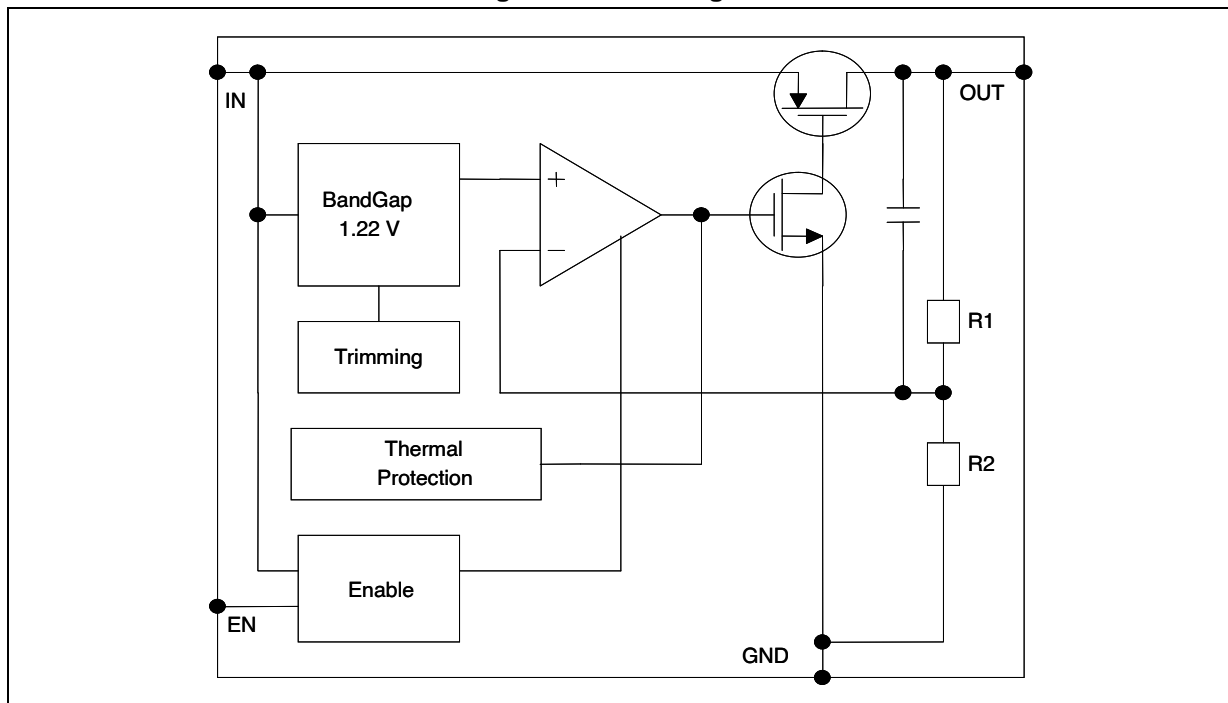

2 Pin configuration

Figure 2. Pin connection (top view)

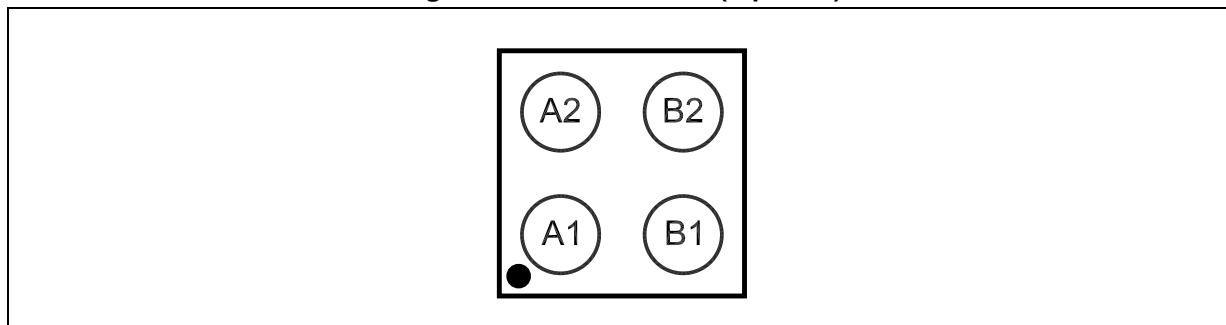
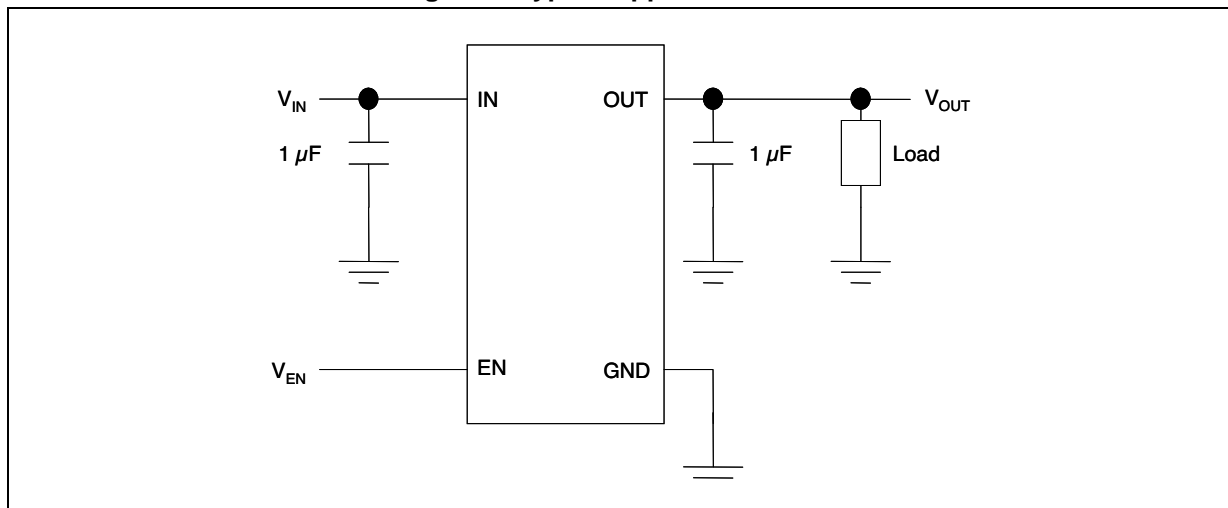

Table 2. Pin description

| Pin n° | Symbol | Function |
|--------|--------|---|
| A2 | EN | Enable pin logic input: low = shutdown, high = active |
| A1 | GND | Common ground |
| B2 | IN | Input voltage of the LDO |
| B1 | OUT | Output voltage |

3 Typical application

Figure 3. Typical application circuit



4 Maximum ratings

Table 3. Absolute maximum ratings

| Symbol | Parameter | Value | Unit |
|-----------|--------------------------------------|-------------------------|------|
| V_{IN} | DC input voltage | - 0.3 to 6 | V |
| V_{OUT} | DC output voltage | - 0.3 to $V_{IN} + 0.3$ | V |
| V_{EN} | Enable input voltage | - 0.3 to $V_{IN} + 0.3$ | V |
| I_{OUT} | Output current | Internally limited | mA |
| P_D | Power dissipation | Internally limited | mW |
| T_{STG} | Storage temperature range | - 65 to 150 | °C |
| T_{OP} | Operating junction temperature range | - 40 to 125 | °C |

Note: Absolute maximum ratings are those values beyond which damage to the device may occur. Functional operation under these conditions is not implied. All values are referred to GND.

Table 4. Thermal data

| Symbol | Parameter | Value | Unit |
|------------|-------------------------------------|-------|------|
| R_{thJA} | Thermal resistance junction-ambient | 180 | °C/W |

5 Electrical characteristics

$T_J = 25\text{ °C}$, $V_{IN} = V_{OUT(NOM)} + 1\text{ V}$, $C_{IN} = C_{OUT} = 1\text{ }\mu\text{F}$, $I_{OUT} = 1\text{ mA}$, $V_{EN} = V_{IN}$, unless otherwise specified.

Table 5. Electrical characteristics ⁽¹⁾

| Symbol | Parameter | Test conditions | Min. | Typ. | Max. | Unit |
|------------------|---|---|------|----------|------|------------------------------|
| V_{IN} | Operating input voltage | | 1.5 | | 5.5 | V |
| V_{UVLO} | Turn-on threshold | | | 1.45 | 1.48 | V |
| | Turn-off threshold | | 1.30 | 1.35 | | mV |
| V_{OUT} | V_{OUT} accuracy | $V_{OUT} > 1.5\text{ V}$, $I_{OUT} = 1\text{ mA}$, $T_J = 25\text{ °C}$ | -2.0 | | 2.0 | % |
| | | $V_{OUT} > 1.5\text{ V}$, $I_{OUT} = 1\text{ mA}$, $-40\text{ °C} < T_J < 125\text{ °C}$ | -3.0 | | 3.0 | % |
| | | $V_{OUT} \leq 1.5\text{ V}$, $I_{OUT} = 1\text{ mA}$ | | ± 10 | | mV |
| | | $V_{OUT} \leq 1.5\text{ V}$, $I_{OUT} = 1\text{ mA}$, $-40\text{ °C} < T_J < 125\text{ °C}$ | | ± 30 | | mV |
| ΔV_{OUT} | Static line regulation | $V_{OUT} + 1\text{ V} \leq V_{IN} \leq 5.5\text{ V}$, $I_{OUT} = 1\text{ mA}$ | | 0.01 | | %/V |
| ΔV_{OUT} | Transient line regulation ⁽²⁾ | $\Delta V_{IN} = +500\text{ mV}$, $I_{OUT} = 1\text{ mA}$, $T_R = T_F = 5\text{ }\mu\text{s}$ | | 10 | | mVpp |
| ΔV_{OUT} | Static load regulation | $I_{OUT} = 1\text{ mA}$ to 300 mA | | 0.002 | | %/mA |
| ΔV_{OUT} | Transient load regulation ⁽²⁾ | $I_{OUT} = 1\text{ mA}$ to 300 mA , $T_R = T_F = 5\text{ }\mu\text{s}$ | | 40 | | mVpp |
| V_{DROP} | Dropout voltage ⁽³⁾ | $I_{OUT} = 300\text{ mA}$, $V_{OUT} > 1.5\text{ V}$, $-40\text{ °C} < T_J < 125\text{ °C}$ | | 200 | 300 | mV |
| e_N | Output noise voltage | 10 Hz to 100 kHz, $I_{OUT} = 10\text{ mA}$ | | 30 | | $\mu\text{V}_{RMS}/\text{V}$ |
| SVR | Supply voltage rejection $V_{OUT} = 1.2\text{ V}$ | $V_{IN} = V_{OUTNOM} + 1\text{ V} \pm V_{RIPPLE}$ $V_{RIPPLE} = 0.1\text{ V}$ Freq. = 1 kHz $I_{OUT} = 10\text{ mA}$ | | 62 | | dB |
| | | $V_{IN} = V_{OUTNOM} + 0.5\text{ V} \pm V_{RIPPLE}$ $V_{RIPPLE} = 0.1\text{ V}$ Freq. = 10 kHz $I_{OUT} = 10\text{ mA}$ | | 62 | | |
| I_Q | Quiescent current | $I_{OUT} = 0\text{ mA}$ | | 20 | | μA |
| | | $I_{OUT} = 0\text{ mA}$, $-40\text{ °C} < T_J < 125\text{ °C}$ | | | 50 | |
| | | $I_{OUT} = 0$ to 300 mA | | 40 | | |
| | | $I_{OUT} = 0$ to 300 mA , $-40\text{ °C} < T_J < 125\text{ °C}$ | | | 85 | |
| | | V_{IN} input current in OFF MODE: $V_{EN} = \text{GND}$ | | 0.001 | 1 | |
| I_{SC} | Short-circuit current | $R_L = 0$ | 400 | | | mA |

Table 5. Electrical characteristics (continued) (1)

| Symbol | Parameter | Test conditions | Min. | Typ. | Max. | Unit |
|------------|--------------------------|--|------|------|------|--------------------|
| V_{EN} | Enable input logic low | $V_{IN}=1.5\text{ V to }5.5\text{ V, }-40\text{ }^{\circ}\text{C}<T_J<125\text{ }^{\circ}\text{C}$ | | | 0.4 | V |
| | Enable input logic high | $V_{IN}=1.5\text{ V to }5.5\text{ V, }-40\text{ }^{\circ}\text{C}<T_J<125\text{ }^{\circ}\text{C}$ | 0.9 | | | |
| I_{EN} | Enable pin input current | $V_{SHDN}=V_{IN}$ | | 0.1 | 100 | nA |
| T_{ON} | Turn-on time (4) | | | 100 | | μs |
| T_{SHDN} | Thermal shutdown | | | 160 | | $^{\circ}\text{C}$ |
| | Hysteresis | | | 20 | | |
| C_{OUT} | Output capacitor | Capacitance (see Section 7: Typical performance characteristics) | 1 | | 22 | μF |

1. For $V_{OUT(NOM)} < 1.2\text{ V}$, $V_{IN} = 1.5\text{ V}$.
2. All transient values are guaranteed by design, not production tested.
3. Dropout voltage is the input-to-output voltage difference at which the output voltage is 100 mV below its nominal value. This specification does not apply for output voltages below 1.5 V.
4. Turn-on time is time measured between the enable input just exceeding V_{EN} high value and the output voltage just reaching 95 % of its nominal value.

6 Soft-start function

The LD39030S has an internal soft-start circuit. By increasing the startup time up to $100\ \mu\text{s}$, without the need of any external soft-start capacitor, this feature is able to reduce the regulator inrush current to 1/3 of the original value.

Figure 4. Soft-start function

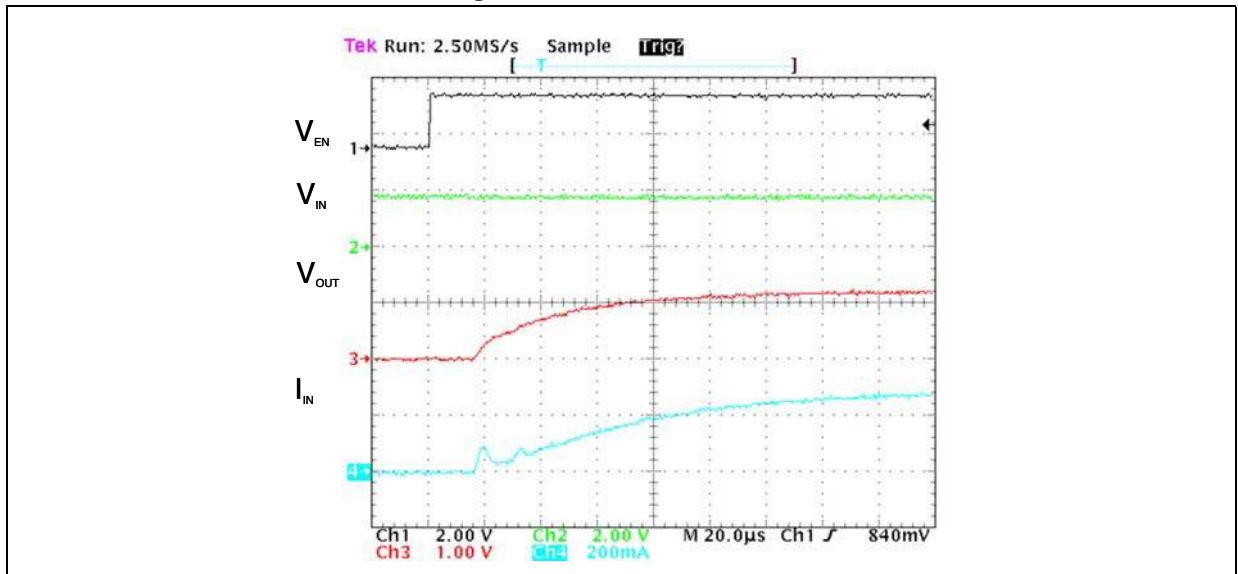

$V_{IN} = 1.8\ \text{V}$, $V_{EN} = 1.8\ \text{V}$, $C_{IN} = 1\ \mu\text{F}$, $C_{OUT} = 1\ \mu\text{F}$.

7 Typical performance characteristics

$C_{IN} = C_{OUT} = 1 \mu F, V_{EN}$ to V_{IN} .

Figure 5. Output voltage vs. temperature

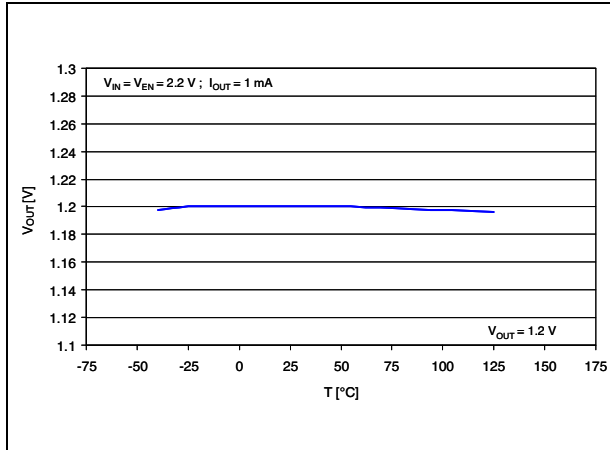

Figure 6. Output voltage vs. input voltage

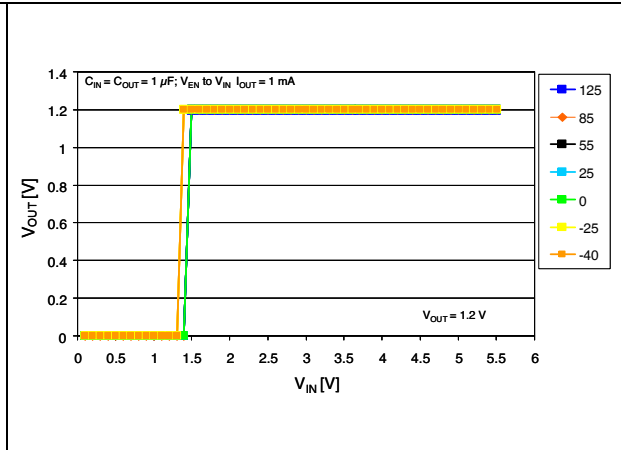

Figure 7. Line regulation vs. temperature

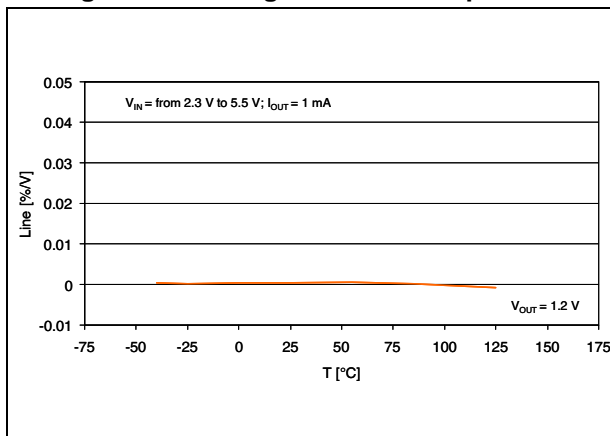

Figure 8. Load regulation vs. temperature

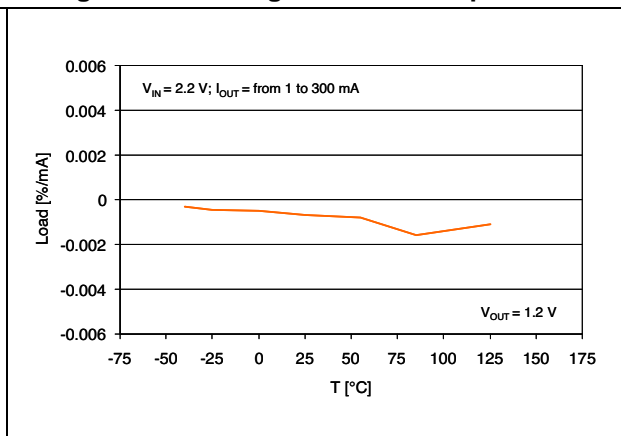

Figure 9. Short-circuit current vs. drop voltage

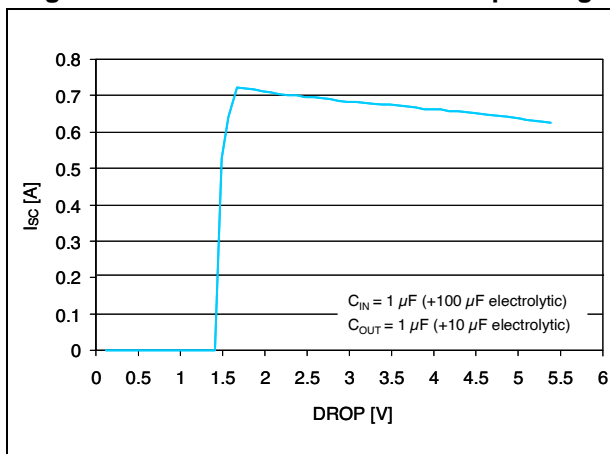

Figure 10. Quiescent current vs. input voltage

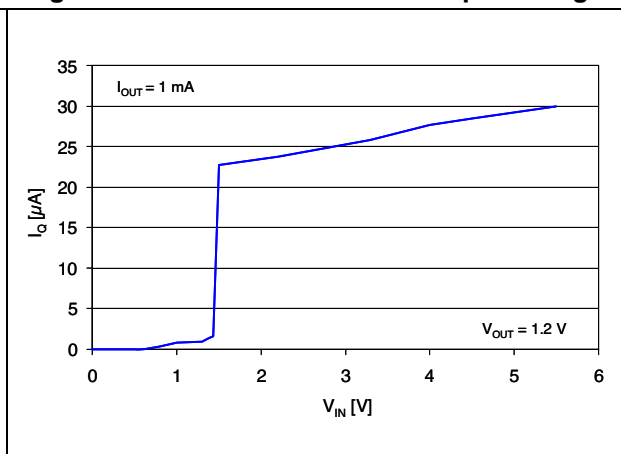

Figure 11. Enable threshold vs. temperature

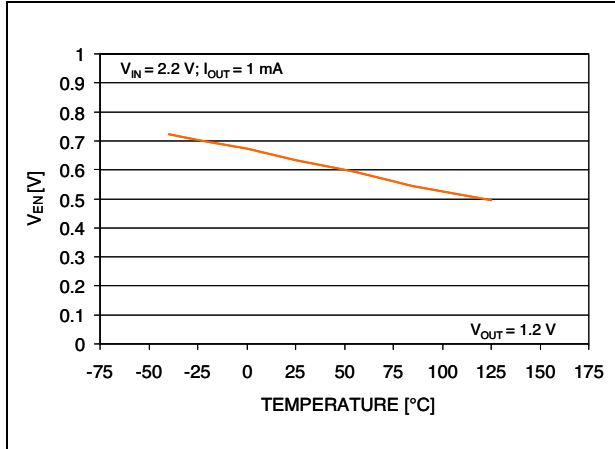

Figure 12. Quiescent current vs. temperature

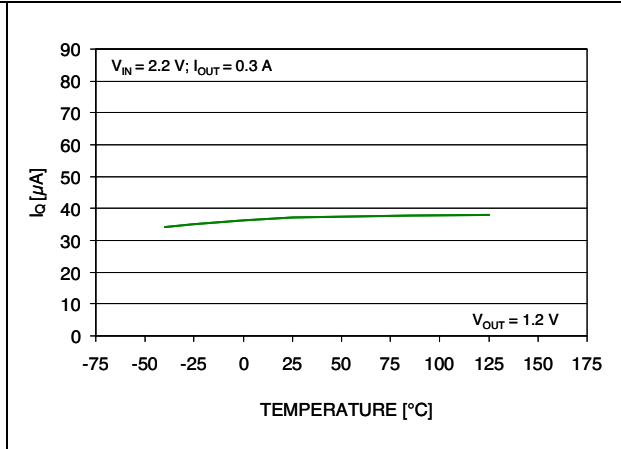

Figure 13. Supply voltage rejection vs. temperature (Freq. = 1 kHz)

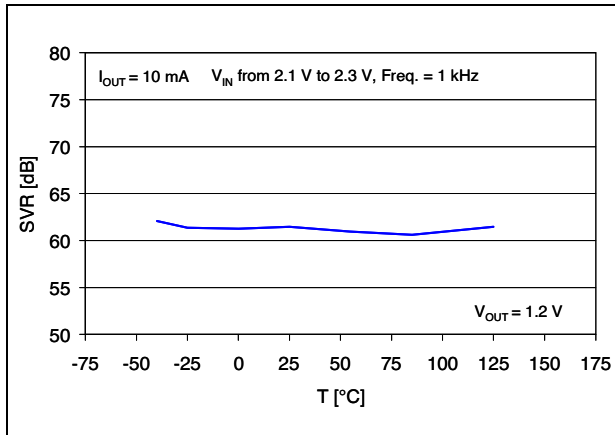

Figure 14. Supply voltage rejection vs. frequency (V_{IN} = 1.6 V to 1.8 V)

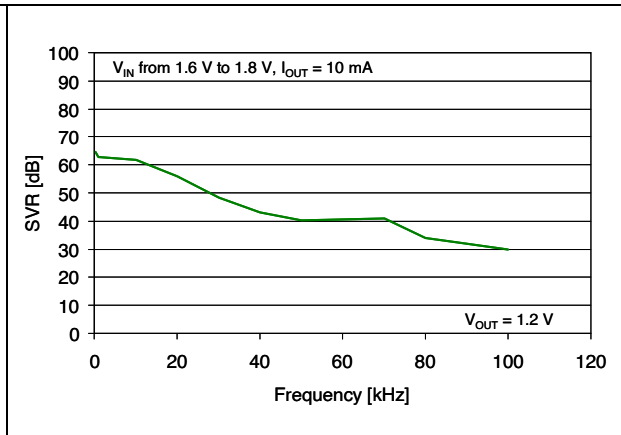

Figure 15. Supply voltage rejection vs. temperature (Freq. = 10 kHz)

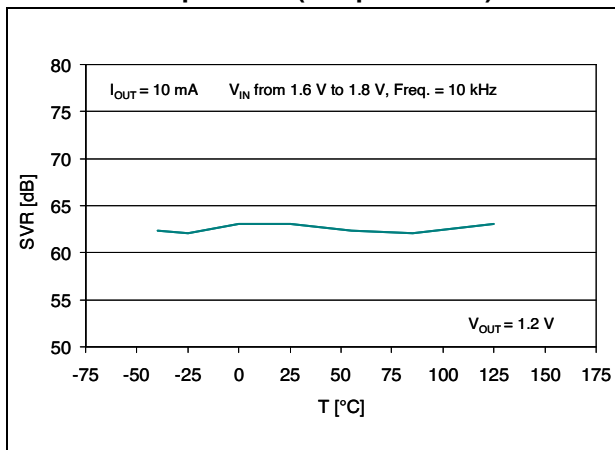

Figure 16. Supply voltage rejection vs. frequency (V_{IN} = 2.1 V to 2.3 V)

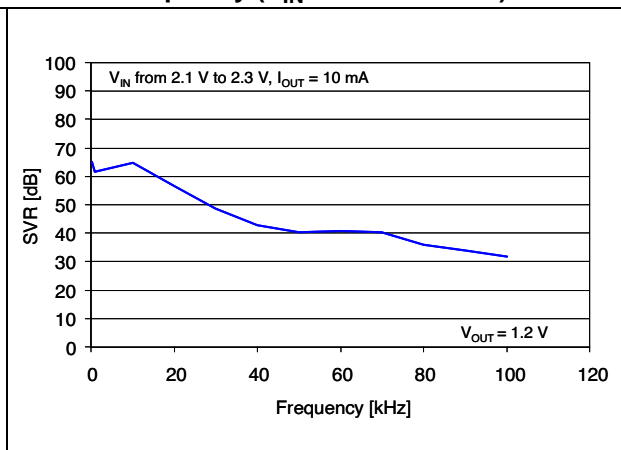

Figure 17. Line transient

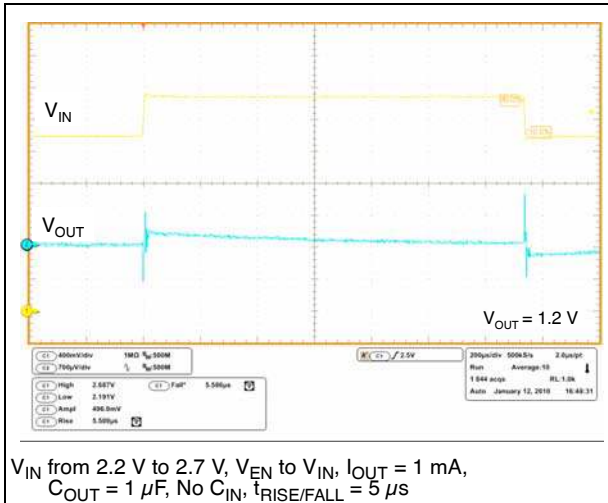

Figure 18. Load transient

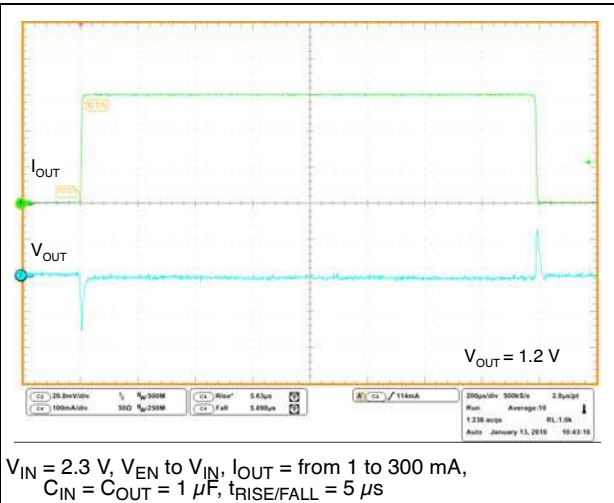

Figure 19. Enable transient

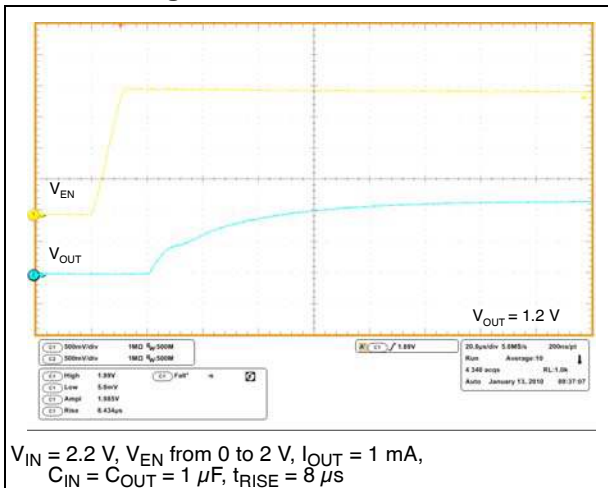

Figure 20. Startup transient

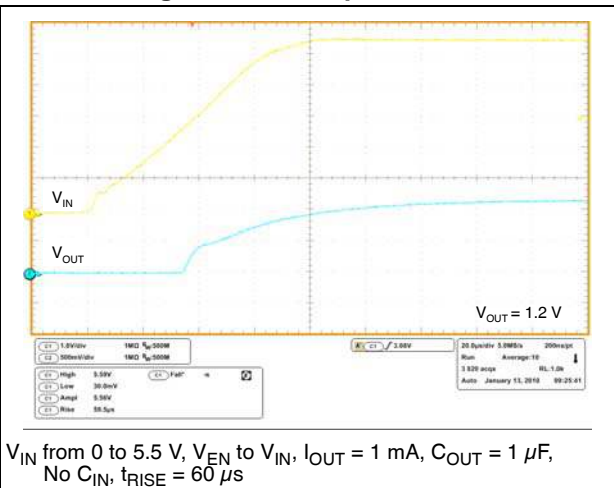
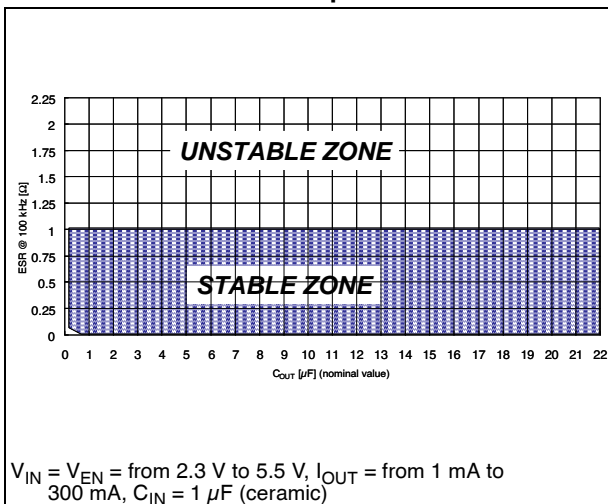

Figure 21. ESR required for stability with ceramic capacitors



8 Package mechanical data

In order to meet environmental requirements, ST offers these devices in different grades of ECOPACK® packages, depending on their level of environmental compliance. ECOPACK specifications, grade definitions, and product status are available at: www.st.com. ECOPACK is an ST registered trademark.

Figure 22. Flip-chip 4 package drawing (dimensions are in mm.)

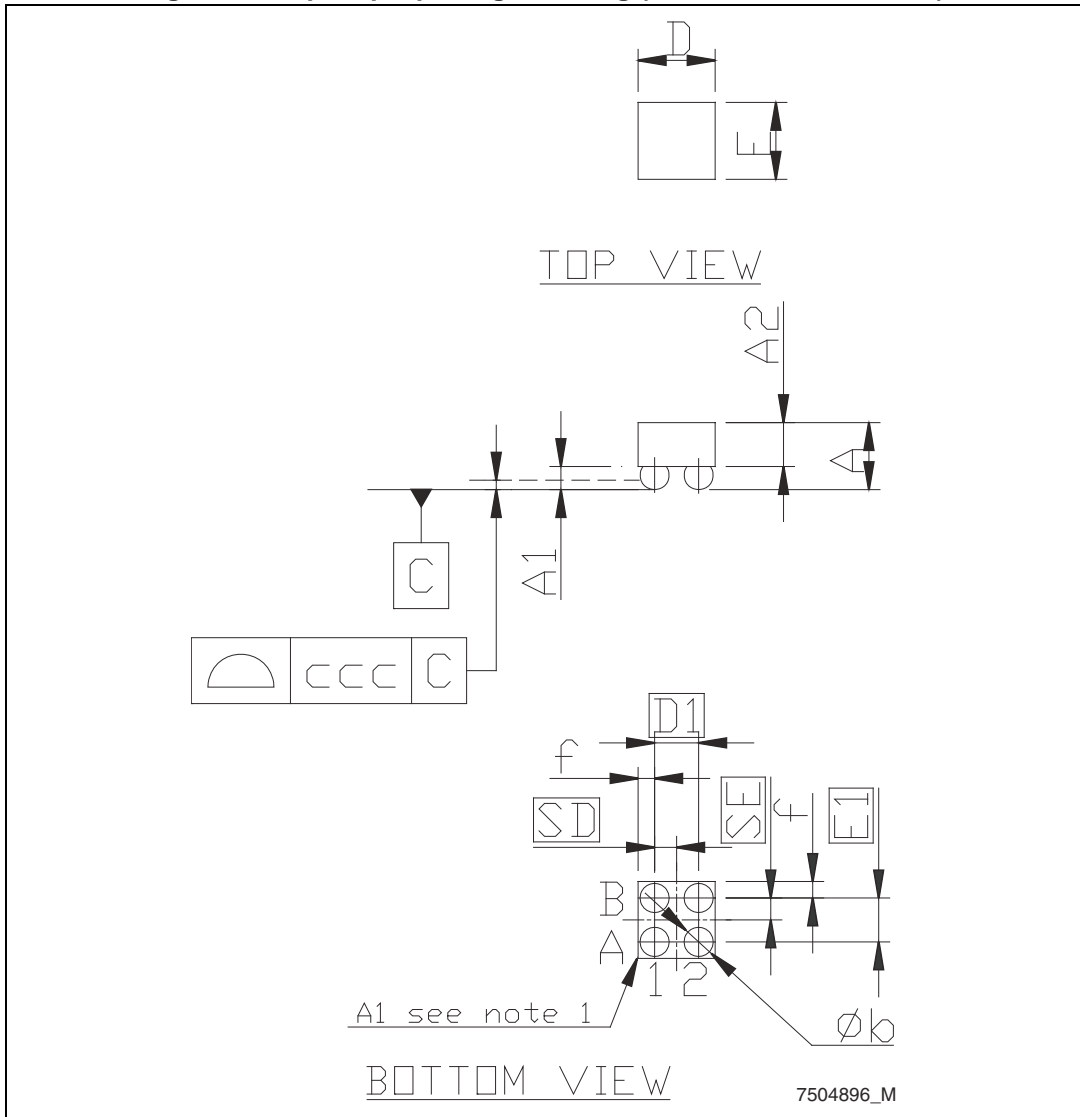
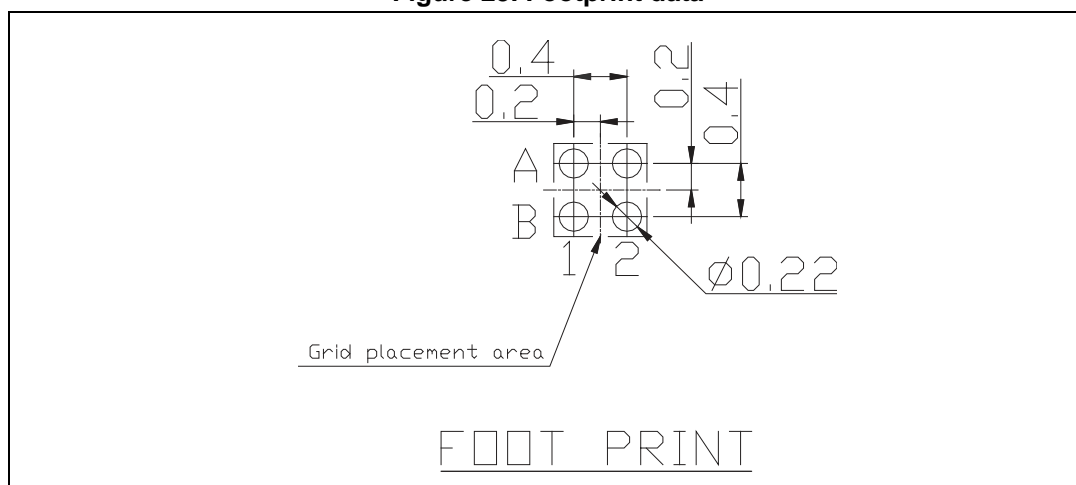

Table 6. Flip-chip 4 package mechanical data

| Dim. | mm. | | |
|------|-------|-------|-------|
| | Min. | Typ. | Max. |
| A | 0.52 | 0.56 | 0.60 |
| A1 | 0.17 | 0.20 | 0.23 |
| A2 | 0.35 | 0.36 | 0.37 |
| b | 0.23 | 0.25 | 0.29 |
| D | 0.758 | 0.788 | 0.818 |
| D1 | | 0.4 | |
| E | 0.758 | 0.788 | 0.818 |
| E1 | | 0.4 | |
| SD | 0.18 | 0.2 | 0.22 |
| SE | 0.18 | 0.2 | 0.22 |
| f | | 0.199 | |
| ccc | | 0.075 | |

Figure 23. Footprint data



9 Packaging mechanical data

Figure 24. Flip-chip 4 tape and reel drawing

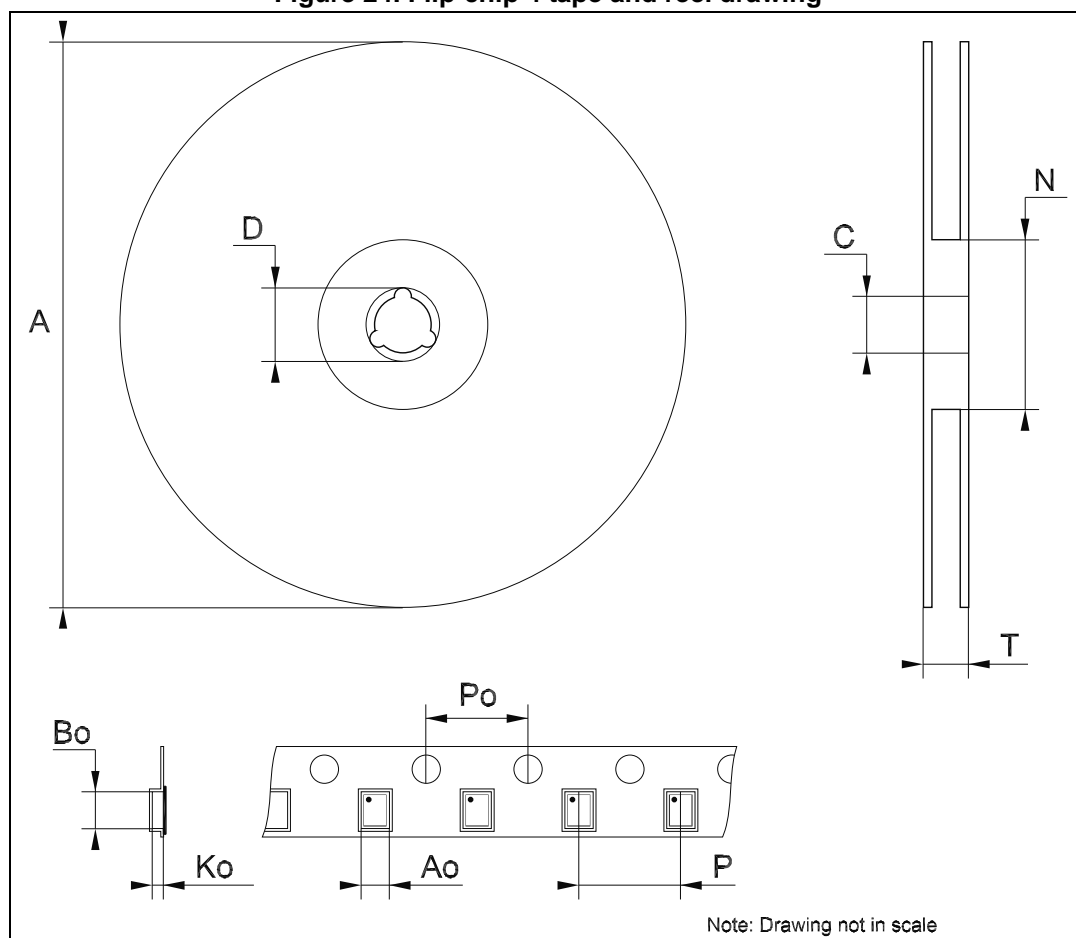

Table 7. Flip-chip 4 tape and reel mechanical data

| Dim. | mm | | |
|------|------|------|------|
| | Min. | Typ. | Max. |
| A | | | 178 |
| C | 12.8 | | 13.2 |
| D | 20.2 | | |
| N | 59 | 60 | 61 |
| T | | | 8.4 |
| Ao | 0.82 | 0.87 | 0.92 |
| Bo | 0.82 | 0.87 | 0.92 |
| Ko | 0.64 | 0.69 | 0.74 |
| Po | 3.9 | 4.0 | 4.1 |
| P | 3.9 | 4.0 | 4.1 |

10 Revision history

Table 8. Document revision history

| Date | Revision | Changes |
|-------------|----------|---|
| 14-Oct-2010 | 1 | First release. |
| 10-Jul-2012 | 2 | Added new order code LD39030SJ33R Table 1 on page 1 . Updated Flip-chip 4 mechanical data Table 6 on page 14 and Figure 22 on page 13 . |
| 25-Oct-2012 | 3 | Added new order code LD39030SJ126R Table 1 on page 1 . Document status promoted from preliminary data to production data. |
| 08-Feb-2013 | 4 | Added Table 7: Options available on request on page 15 . |
| 06-Feb-2014 | 5 | Part number LD39030SJxx changed to LD39030SJ. Updated Table 1: Device summary , Section 8: Package mechanical data and Section 9: Packaging mechanical data . Minor text changes. |

Please Read Carefully:

Information in this document is provided solely in connection with ST products. STMicroelectronics NV and its subsidiaries ("ST") reserve the right to make changes, corrections, modifications or improvements, to this document, and the products and services described herein at any time, without notice.

All ST products are sold pursuant to ST's terms and conditions of sale.

Purchasers are solely responsible for the choice, selection and use of the ST products and services described herein, and ST assumes no liability whatsoever relating to the choice, selection or use of the ST products and services described herein.

No license, express or implied, by estoppel or otherwise, to any intellectual property rights is granted under this document. If any part of this document refers to any third party products or services it shall not be deemed a license grant by ST for the use of such third party products or services, or any intellectual property contained therein or considered as a warranty covering the use in any manner whatsoever of such third party products or services or any intellectual property contained therein.

UNLESS OTHERWISE SET FORTH IN ST'S TERMS AND CONDITIONS OF SALE ST DISCLAIMS ANY EXPRESS OR IMPLIED WARRANTY WITH RESPECT TO THE USE AND/OR SALE OF ST PRODUCTS INCLUDING WITHOUT LIMITATION IMPLIED WARRANTIES OF MERCHANTABILITY, FITNESS FOR A PARTICULAR PURPOSE (AND THEIR EQUIVALENTS UNDER THE LAWS OF ANY JURISDICTION), OR INFRINGEMENT OF ANY PATENT, COPYRIGHT OR OTHER INTELLECTUAL PROPERTY RIGHT.

ST PRODUCTS ARE NOT DESIGNED OR AUTHORIZED FOR USE IN: (A) SAFETY CRITICAL APPLICATIONS SUCH AS LIFE SUPPORTING, ACTIVE IMPLANTED DEVICES OR SYSTEMS WITH PRODUCT FUNCTIONAL SAFETY REQUIREMENTS; (B) AERONAUTIC APPLICATIONS; (C) AUTOMOTIVE APPLICATIONS OR ENVIRONMENTS, AND/OR (D) AEROSPACE APPLICATIONS OR ENVIRONMENTS. WHERE ST PRODUCTS ARE NOT DESIGNED FOR SUCH USE, THE PURCHASER SHALL USE PRODUCTS AT PURCHASER'S SOLE RISK, EVEN IF ST HAS BEEN INFORMED IN WRITING OF SUCH USAGE, UNLESS A PRODUCT IS EXPRESSLY DESIGNATED BY ST AS BEING INTENDED FOR "AUTOMOTIVE, AUTOMOTIVE SAFETY OR MEDICAL" INDUSTRY DOMAINS ACCORDING TO ST PRODUCT DESIGN SPECIFICATIONS. PRODUCTS FORMALLY ESCC, QML OR JAN QUALIFIED ARE DEEMED SUITABLE FOR USE IN AEROSPACE BY THE CORRESPONDING GOVERNMENTAL AGENCY.

Resale of ST products with provisions different from the statements and/or technical features set forth in this document shall immediately void any warranty granted by ST for the ST product or service described herein and shall not create or extend in any manner whatsoever, any liability of ST.

ST and the ST logo are trademarks or registered trademarks of ST in various countries.

Information in this document supersedes and replaces all information previously supplied.

The ST logo is a registered trademark of STMicroelectronics. All other names are the property of their respective owners.

© 2014 STMicroelectronics - All rights reserved

STMicroelectronics group of companies

Australia - Belgium - Brazil - Canada - China - Czech Republic - Finland - France - Germany - Hong Kong - India - Israel - Italy - Japan - Malaysia - Malta - Morocco - Philippines - Singapore - Spain - Sweden - Switzerland - United Kingdom - United States of America

www.st.com