

CHARACTERISTICS

CONTACT ARRANGEMENT: DPDT-DB
 PRETRAVEL: 1.52 [.06] MAX
 OVERTRAVEL: 0.51 [.02] MIN
 OPERATING FORCE: 510±142g [18±5 oz]
 RELEASE FORCE: 142g [5 oz] MIN
 MOVEMENT DIFFERENTIAL: 0.64±0.25 [.025±.01]
 AMBIENT TEMPERATURE RANGE: -65°C TO +125°C
 RESET TRAVEL: 0.13 [.005] MIN
 INITIAL CONTACT RESISTANCE: .025 OHMS MAX FROM TERMINAL

INITIAL DIELECTRIC WITHSTANDING VOLTAGE BETWEEN ALL
 TERMINALS AND BETWEEN ALL TERMINALS AND MOUNTING PLATE:
 SEA LEVEL 1000 VRMS
 ALTITUDE (70,000 FT): 400 VRMS

ELECTRICAL RATING

LOAD	SEA LEVEL				70,000 FT.	
	28VDC DPDT	28VDC 4 CKT	115VAC 60 HZ DPDT	115VAC 60 HZ 4 CKT	28VDC DPDT	28VDC 4 CKT
RESISTIVE	8 AMP	8 AMP	6 AMP	4 AMP	8 AMP	8 AMP
INDUCTIVE	6 AMP	4 AMP	4 AMP	4 AMP	2 AMP	1 AMP
LAMP	0.5 AMP	0.5 AMP	2 AMP	1 AMP	-----	-----

NOTES :

- CONTACTS ARE ENHANCED GOLD
- POLE SIMULTANEITY WITHIN .002 OF BUTTON TRAVEL
- SWITCH IS DESIGNED TO MEET MIL-PRF-8805/77-003
- CASE MATERIAL:
HIGH PERFORMANCE THERMOPLASTIC
- MARKING SHALL BE PERMANENT, REMAIN LEGIBLE AFTER COMPLETION OF THE SOLVENT RESISTENCE TEST IN ACCORDANCE WITH MIL-STD-202, METHOD 215, AND MUST NOT OBSCURE TERMINAL DESIGNATIONS ON CASE

LABEL:
 26-810
 8 AMP 125/250 VAC
 4 DIGIT DATE CODE (YYWW)

6.  MARK ARE CRITICAL DIMENSION

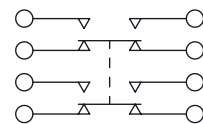

SCHEMATIC

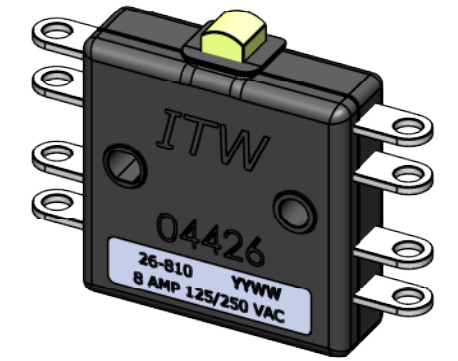
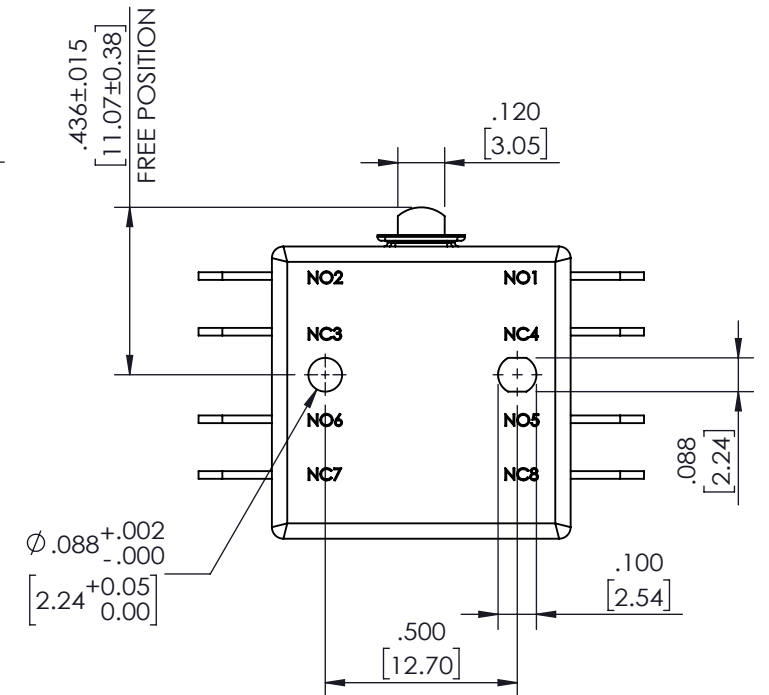
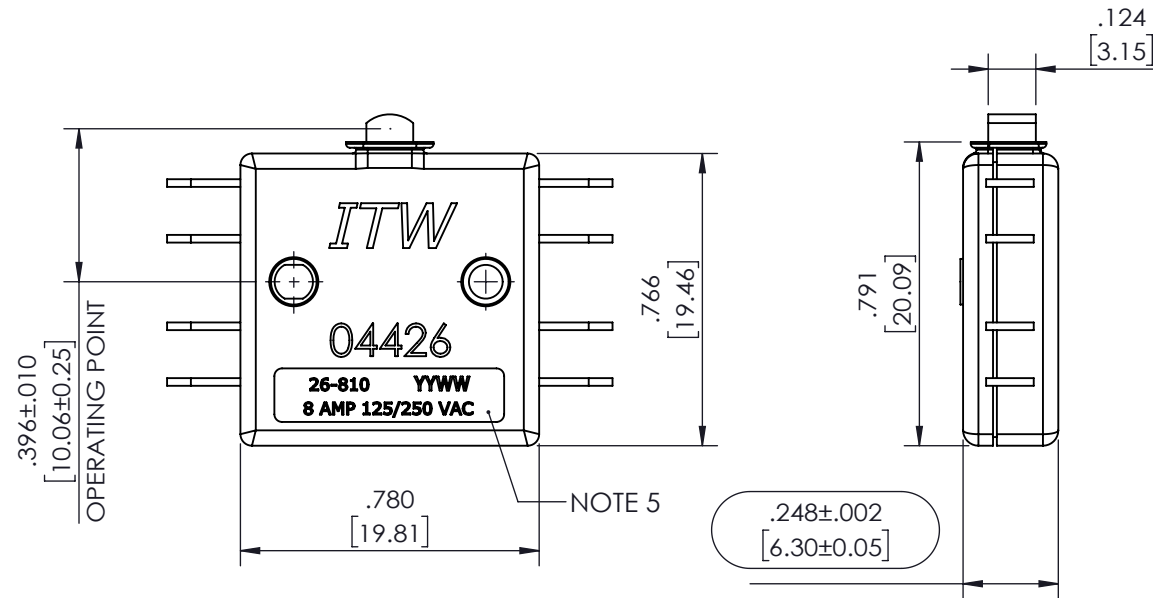
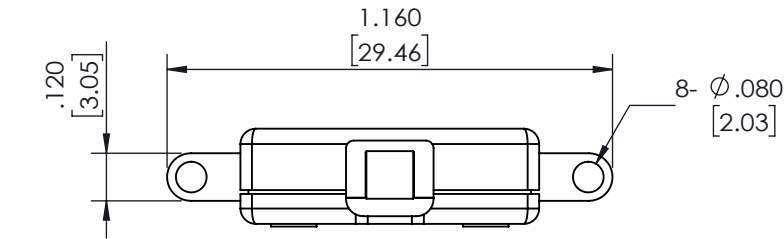

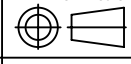
DWG TYPE SALES DRAWING	DRAWN ee	TOLERANCES: UNLESS OTHERWISE NOTED X.XX ± .01 X.XXX ± .005 ANGULAR ±0.5°	DWG TITLE T-26 SWITCH END TERM.									
STATUS RELEASE	REVIEW --		DWG NO. W26-810									
This document is the intellectual property of ITW Electronic Business Asia Co., Limited and may contain confidential, proprietary, privileged information protected by law. Neither this document nor any information it contains can be reproduced, transformed to any other format, or distributed, without written permission by ITW Electronic Business Asia Co., Limited. 本文作為安泰維百電器股份有限公司之智慧財產，非經許可不得翻取、複製、轉變成其他形式使用或散佈			APPROVED --	THIRD ANGLE PROJECTION 	DATE 2022.07.29	REF: --	<input checked="" type="checkbox"/> 管制文件 <input type="checkbox"/> 非管制文件	Unit inch / mm	SCALE 2 : 1	REV 1	RoHS Compliant	SHEET 1 OF 2

REVISION RECORD

REV.	DESCRIPTION	DATE	DRAWN BY	DOCUMENT NO.
1	FOR SALES DRAWING	2022.07.29	C.C.	DCN-202200062

DWG TYPE SALES DRAWING	DRAWN <i>c.c.</i>	TOLERANCES: UNLESS OTHERWISE NOTED X.X ± 0.5 X.XX ± .01 ANGULAR ±0.5°	DWG TITLE T-26 SWITCH END TERM.						
STATUS RELEASE	REVIEW --		DWG NO. W26-810						
<small>This document is the intellectual property of ITW Electronic Business Asia Co., Limited and may contain confidential, proprietary, privileged information protected by law. Neither this document nor any information it contains can be reproduced, transformed to any other format, or distributed, without written permission by ITW Electronic Business Asia Co., Limited. 本文件為安天德百電股份有限公司之智慧財產，非經許可不得翻印、複製、轉變成其他形式使用或散佈。</small>			DATE 2022.07.29	REF: --	<input checked="" type="checkbox"/> 管制文件 <input type="checkbox"/> 非管制文件		Unit inch / mm	SCALE 2 : 1	REV 1