

RTQ6361GQW, 60V_{IN}, 1.5A, Asynchronous Step-Down Converter Evaluation Board

General Description

The Evaluation Board demonstrates the RTQ6361GQW to be designed for a 5V/1.5A output from a 8V to 60V input at 500kHz switching frequency. The wide input range makes it suitable for communications and industrial 12V, 24V and 48V power systems. The RTQ6361GQW provides complete protection functions such as input under-voltage lockout, output under-voltage protection, over-current protection and thermal shut down. Cycle-by-cycle current limit provides protection against shorted outputs and soft-start eliminates input current surge during start-up.

Table of Contents

General Description	1
Performance Sepcification Summary	2
Power-up Procedure	2
Detailed Description of Hardware	3
Bill of Materials	5
Typical Applications	6
Evaluation Board Layout	9
More Information.....	11
Important Notice for Richtek Evaluation Board	11

Performance Sepcification Summary

Summary of the RTQ6361GQW Evaluation Board performance specifiaiton is provided in Table 1. The ambient temperature is 25°C.

Table 1. RTQ6361GQW Evaluation Board Performance Specification Summary

Specification	Test Conditions	Min	Typ	Max	Unit
Input Voltage Range		8	--	60	V
Output Current		0	--	1.5	A
Default Output Voltage		--	5	--	V
Operation Frequency		--	500	--	kHz
Output Ripple Voltage	$I_{OUT} = 1.5A$	--	10	--	mVp-p
Line Regulation	$I_{OUT} = 1.5A, V_{IN} = 8V \text{ to } 60V$	--	± 1	--	%
Load Regulation	$V_{IN} = 12V, I_{OUT} = 0.001 A \text{ to } 1.5A$	--	± 1	--	%
Load Transient Response	$I_{OUT} = 0.75A \text{ to } 1.5A$	--	± 5	--	%
Maximum Efficiency	$V_{IN} = 12V, V_{OUT} = 5V, I_{OUT} = 1.5A$	--	88.9	--	%

Power-up Procedure

Suggestion Required Equipments

- RTQ6361GQW Evaluation Board
- DC power supply capable of at least 60V and 2A
- Electronic load capable of 6A
- Function Generator
- Oscilloscope

Quick Start Procedures

The Evaluation Board is fully assembled and tested. Follow the steps below to verify board operation. Caution: Do not turn on supplies until all connections are made. Note : When measuring the output voltage ripple, care must be taken to avoid a long ground lead on the oscilloscope probe. Measure the output voltage ripple by touching the probe tip and ground ring directly across the last output capacitor.

Proper measurement equipment setup and follow the procedure below.

- 1) With power off, connect the input power supply to VIN and GND pins.
- 2) With power off, connect the electronic load between the VOUT and nearest GND pins.
- 3) Turn on the power supply at the input. Make sure that the input voltage does not exceeds 60V on the Evaluation Board.
- 4) Check for the proper output voltage using a voltmeter.
- 5) Once the proper output voltage is established, adjust the load within the operating ranges and observe the output voltage regulation, ripple voltage, efficiency and other performance.

Detailed Description of Hardware

Headers Description and Placement

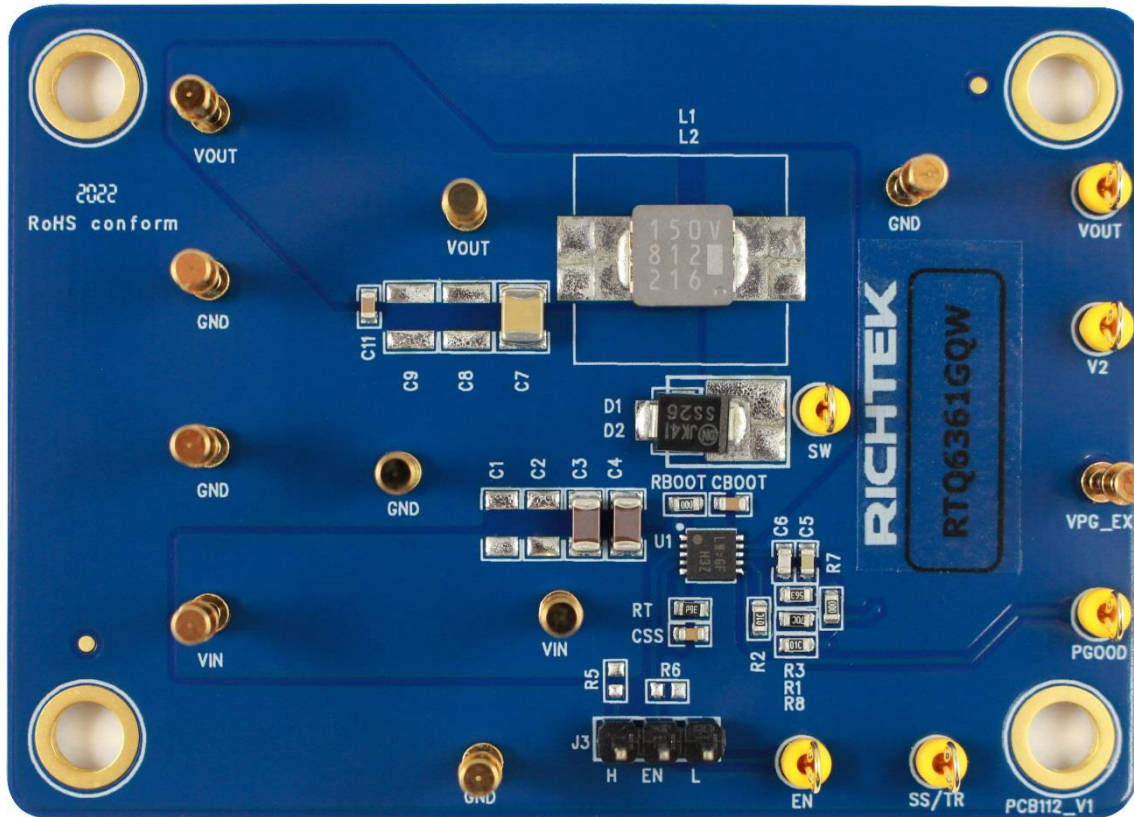

Carefully inspect all the components used in the EVB according to the following Bill of Materials table, and then make sure all the components are undamaged and correctly installed. If there is any missing or damaged component, which may occur during transportation, please contact our distributors or e-mail us at evb_service@richtek.com.

Test Points

The EVB is provided with the test points and pin names listed in the table below.

Test Point/ Pin Name	Function
VIN	Input voltage.
VOUT	Output voltage.
GND	Ground.
EN	Enable test point.
J3	EN jumper. Connect EN to ground to disable, open to enable.
SW	Switch node test point.

Test Point/ Pin Name	Function
V2	Test pin V2 is used for bode plot measurement. Connect VOUT pin and this pin to the injection transformer.
SS/TR	Soft-start and tracking test point.
VPG_Ext	Test point for pull up voltage of the Open-drain power-good indication output.
PGOOD	Power-good indication test point.

Bill of Materials

V _{IN} = 12V, V _{OUT} = 5.0V, I _{OUT} = 1.5A, f _{sw} = 500kHz						
Reference	Count	Part Number	Value	Description	Package	Manufacturer
U1	1	RTQ6361GQW	RTQ6361GQW	Step-Down Converter	WDFN-10SL 3x3	RICHTEK
C3, C4	2	HMK316AC7225KLHTE	2.2μF	Capacitor, Ceramic, 100V, X7R	1206	Taiyo Yuden
C5	1	0603B182K500CT	1.8nF	Capacitor, Ceramic, 50V, X7R	0603	WALSIN
C6	1	0603N180J500CT	18pF	Capacitor, Ceramic, 50V, NPO	0603	WALSIN
C7	1	GRM32ER61C476KE15L	47μF	Capacitor, Ceramic, 16V, X5R	1210	MURATA
C11	1	C1608X7R1H104KT	0.1μF	Capacitor, Ceramic, 50V, X7R	0603	TDK
CBOOT	1	C1608X7R1H104KT	0.1μF	Capacitor, Ceramic, 50V, X7R	0603	TDK
CSS	1	C1608X7R1H103KT000N	10nF	Capacitor, Ceramic, 50V, X7R	0603	TDK
D1	1	SS26	Schottky Diode, 60V/2A	Schottky Diode, 60V/2A	SMB	ON Semiconductor
L1	1	ETQP3M150KVN	15μH	Inductor, I _{sat} = 5.1A, 99.2mΩ		Panasonic
R1	1	WR06X5232FTL	52.3k	Resistor, Chip, 1/10W, 1%	0603	WALSIN
R2, R8	2	WR06X1002FTL	10k	Resistor, Chip, 1/10W, 1%	0603	WALSIN
R3	1	WR06X5602FTL	56k	Resistor, Chip, 1/10W, 1%	0603	RALEC
R7, RBOOT	2	WR06X000 PTL	0	Resistor, Chip, 1/10W, 1%	0603	WALSIN
RT	1	RTT032323FTP	232k	Resistor, Chip, 1/10W, 1%	0603	RALEC

Typical Applications

EVB Schematic Diagram

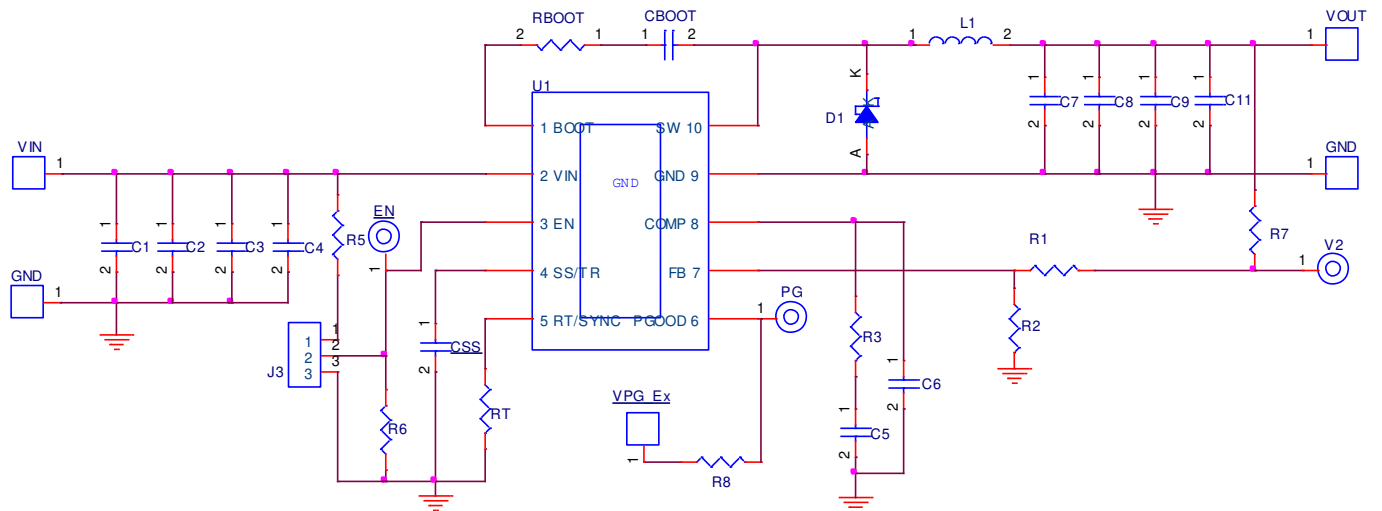

1. The capacitance values of the input and output capacitors will influence the input and output voltage ripple.
2. MLCC capacitors have degrading capacitance at DC bias voltage, and especially smaller size MLCC capacitors will have much lower capacitance.

Measure Result

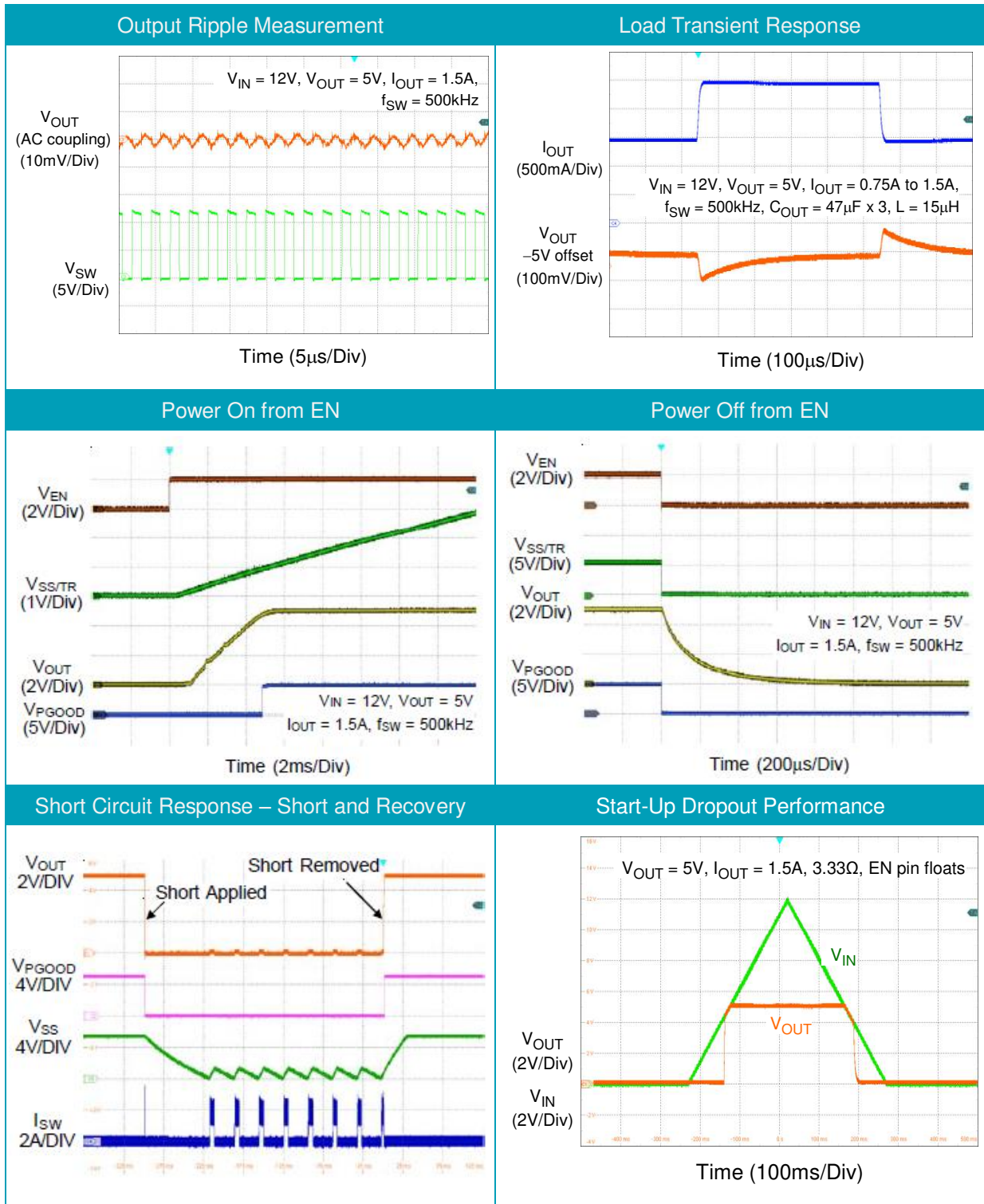

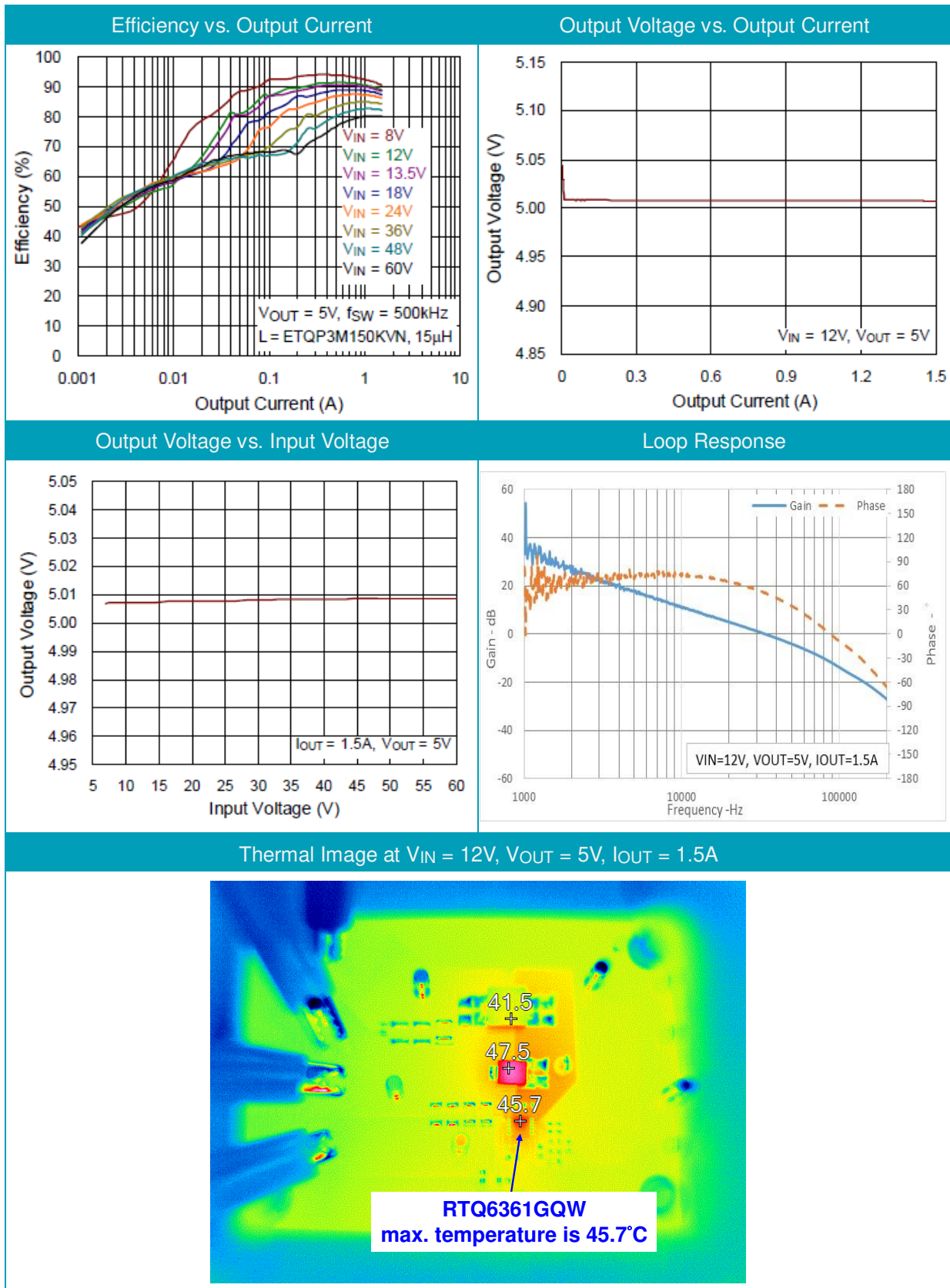

Note : When measuring the input or output voltage ripple, care must be taken to avoid a long ground lead on the oscilloscope probe. Measure the output voltage ripple by touching the probe tip directly across the output capacitor.

Evaluation Board Layout

Figure 1 to Figure 4 are RTQ6361GQW Evaluation Board layout. This board size is 70mm x 50mm and is constructed on four-layer PCB, outer layers with 2 oz. Cu and inner layers with 1 oz. Cu.

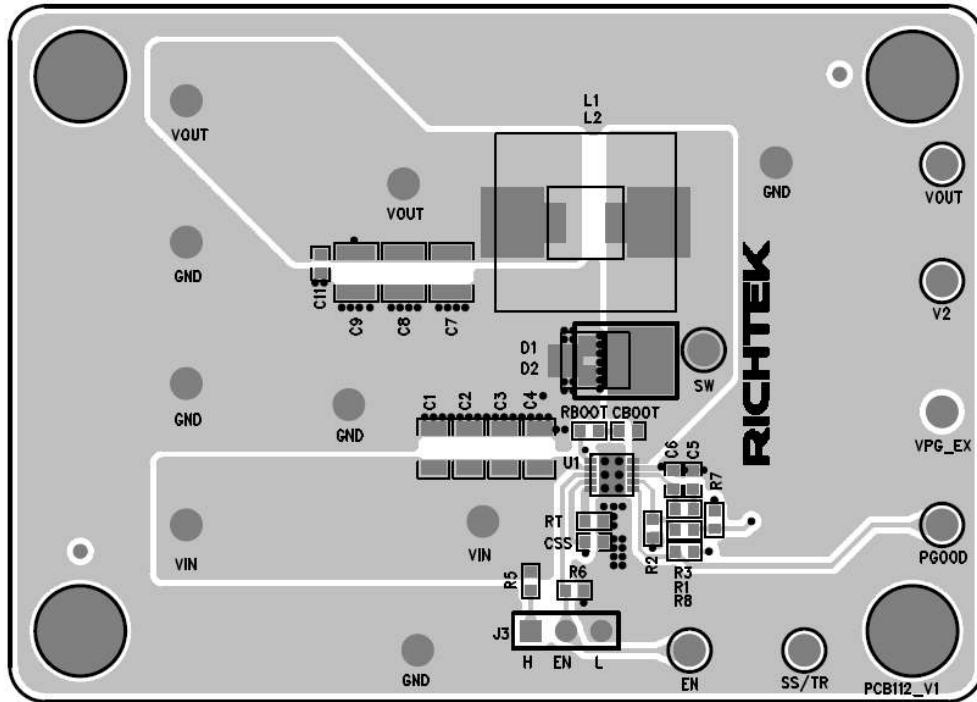

Figure 1. Top View (1st layer)

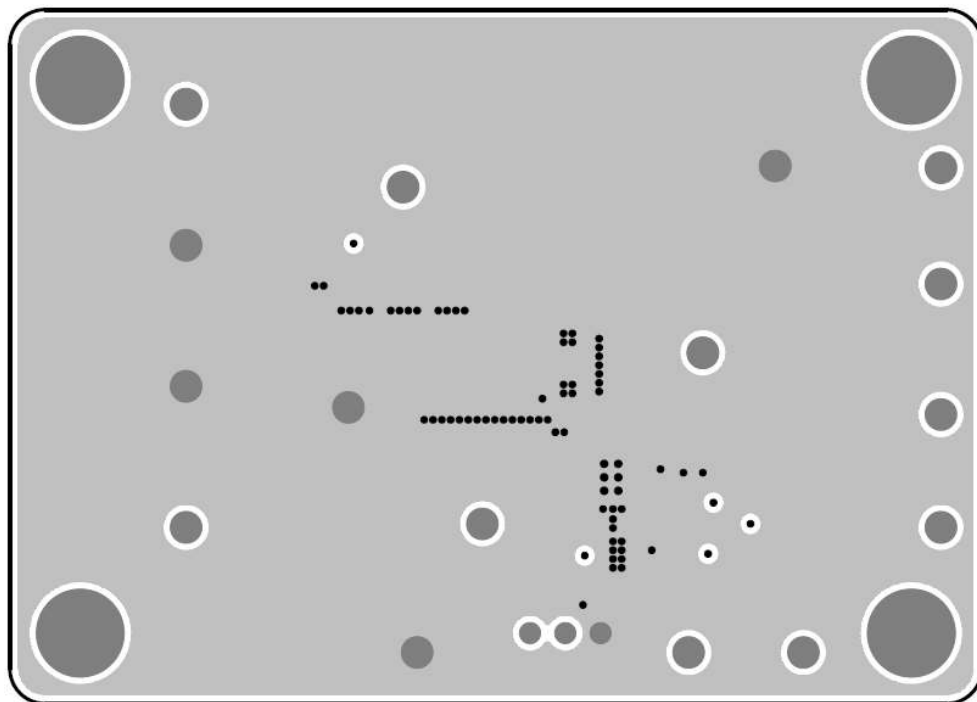

Figure 2. PCB Layout—Inner Side (2nd Layer)

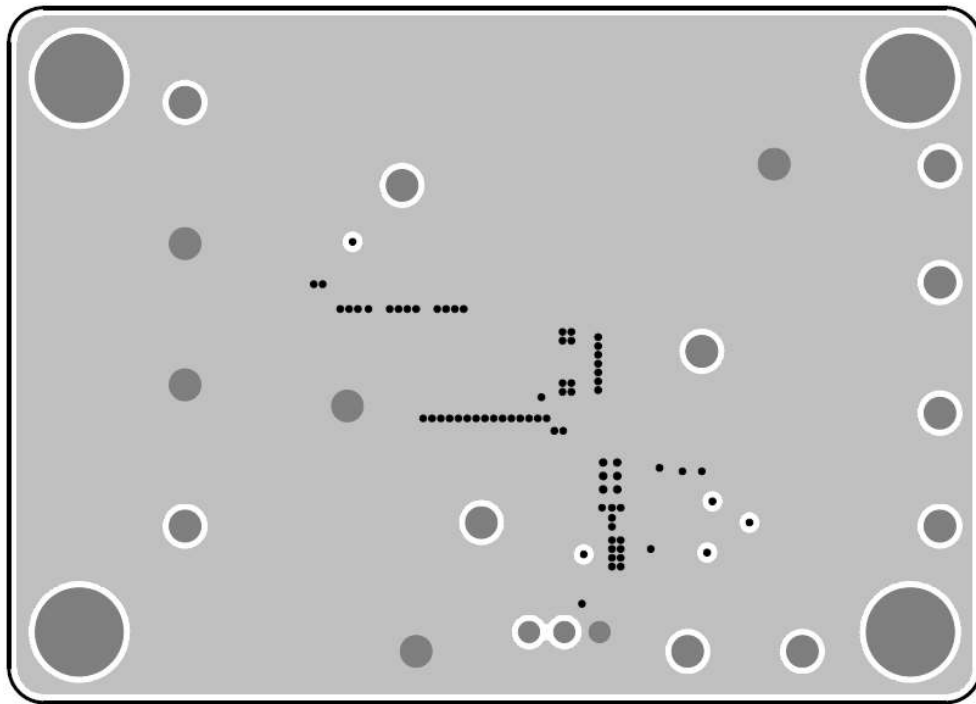

Figure 3. PCB Layout—Inner Side (3rd Layer)

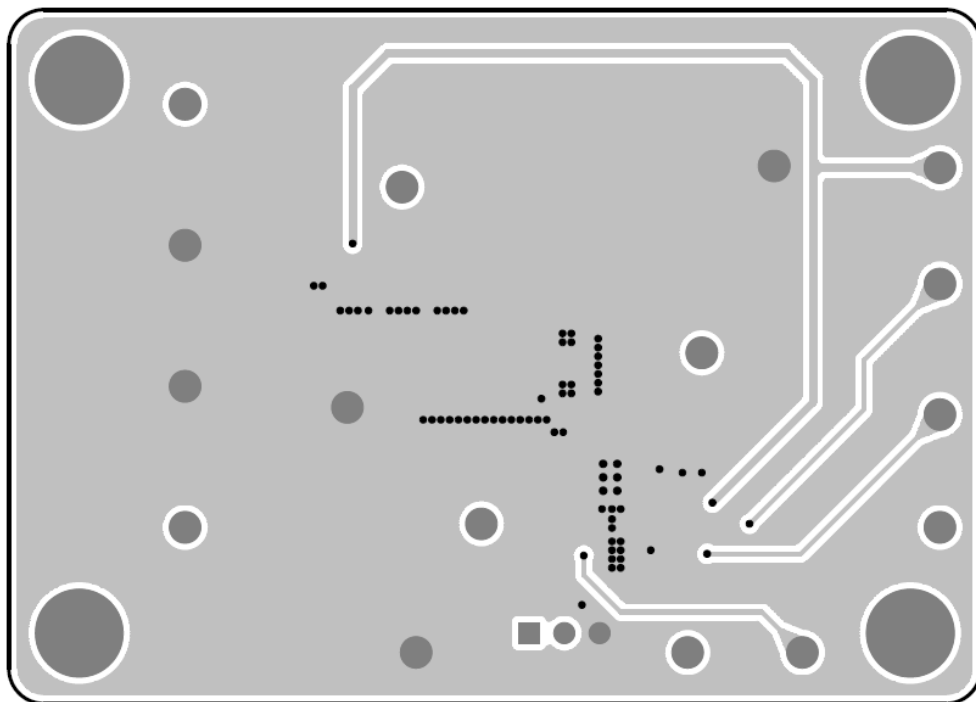

Figure 4. Bottom View (4th Layer)

More Information

For more information, please find the related datasheet or application notes from Richtek website <http://www.richtek.com>.

Important Notice for Richtek Evaluation Board

THIS DOCUMENT IS FOR REFERENCE ONLY, NOTHING CONTAINED IN THIS DOCUMENT SHALL BE CONSTRUED AS RICHTEK'S WARRANTY, EXPRESS OR IMPLIED, UNDER CONTRACT, TORT OR STATUTORY, WITH RESPECT TO THE PRESENTATION HEREIN. IN NO EVENT SHALL RICHTEK BE LIABLE TO BUYER OR USER FOR ANY AND ALL DAMAGES INCLUDING WITHOUT LIMITATION TO DIRECT, INDIRECT, SPECIAL, PUNITIVE OR CONSEQUENTIAL DAMAGES.