

Style
M12 Socket, shielded
5 pin
A-coding

Ratings
Voltage: 60 V
Current: 4 A

Operating Temperature Range
-40~105 °C

Materials
① Insulator: Polyamide 66 (PA66), UL94 HB, black
② Pin: C5191 phosphor bronze, gold plated
③ Shell: C3604 brass, nickel plated
④ Nut: C3604 brass, nickel plated
⑤ O-ring: Nitrile rubber, green/black

Electrical Requirements
Dielectric strength: 1 min @ 500 Vac
Insulation resistance: 100 MΩ @ 500 Vdc
Contact resistance: 10 mΩ or less

Mechanical Requirements
Life cycle: 500 mating cycles minimum

Environmental Requirements
Salt spray test: 35 °C, relative humidity 90-95%, 5% NaCl mist for 48 hrs. Wash parts after test. Maintain mechanical requirements and a contact resistance of less than 10 mΩ.
Waterproof: IP67

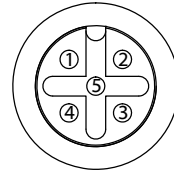

Front View
Not to Scale

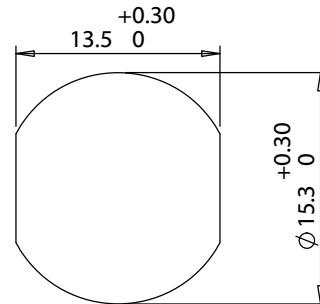
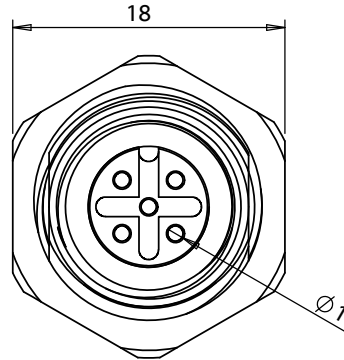

Panel cutout (PG9)
Panel thickness (4.5mm max.)

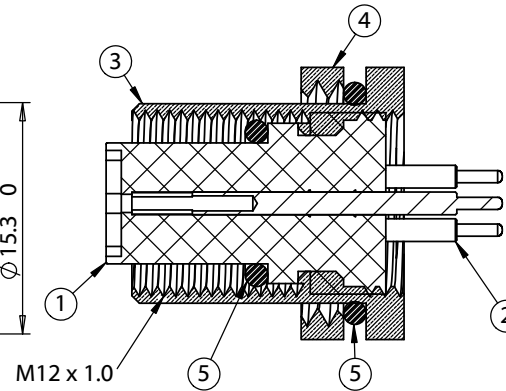
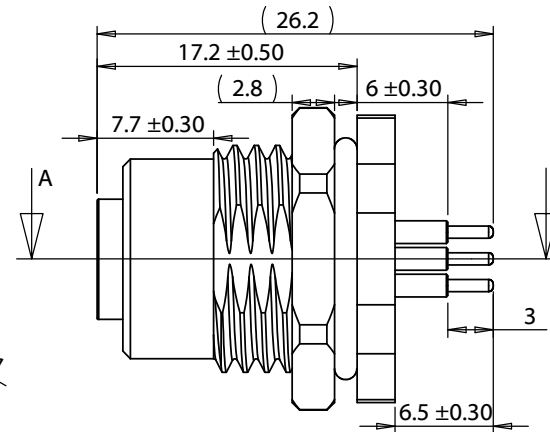

SECTION A-A

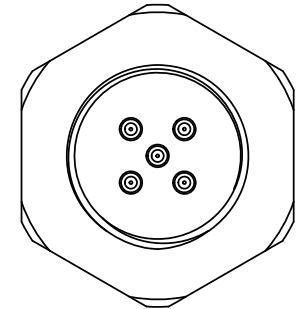
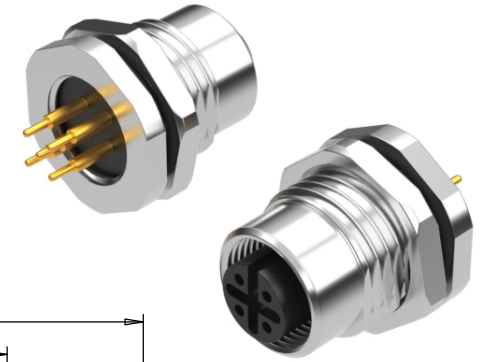

PCB Layout

Revision:	Date:	Description:
A	10/6/2020	Initial release

Prepared:
JC
Digitally signed by JC
Date: 2020.10.23 15:37:02
+07'00'

Verified:
AG
Digitally signed by AG
Date: 2020.10.23 15:47:35
+07'00'

Dimensions are in millimeters.
Tolerances:
X: ± 0.3 mm
X.X: ± 0.1 mm
X.XX: ± 0.05 mm

Notes:
RoHS compliant

Function test: no open, no short circuit, no intermittent

Description:
Connector, 5 pin M12 A-code socket, 12xL26.2mm, gold plated, panel mount, PCB, IP67

TENSILITY

tel 1.541.323.3228 800 877.670.7118
fax 1.541.323.4202 web tensility.com

Size: A Part number: 54-00236

Scale: 2:1

Sheet 1 of 1