

User Guide for
FEBFSFR2100_D015v1
Evaluation Board

LCD TV Power Supply

Featured Fairchild Product:
FSFR2100

***Direct questions or comments
about this evaluation board to:
“Worldwide Direct Support”***

Fairchild Semiconductor.com

Table of Contents

1. General Board Description	3
1.1. Featured Fairchild Products	3
1.2. Power Supply Specification Table	3
1.3. Schematic of the FSFR2100 Evaluation Board	4
1.4. Photographs of the FSFR2100 Evaluation Board.....	5
1.5. Bill of Materials.....	6
1.6. Transformer Specification	7
1.7. FSFR2100 (LLC) Printed Circuit Board Image	8
2. Test Results.....	9
2.1. Primary-Side MOSFET Voltage and Current Waveforms.....	9
2.2. Secondary-Side Rectifier Diodes Voltage and Current Waveforms	11
2.3. On/Off Waveforms	13
2.4. Output Voltage Ripple.....	15
2.5. Hold-up Time Test.....	16
2.6. Protection Operation Waveforms	17
2.7. Efficiency.....	18
3. Revision History	19

1. General Board Description

This user guide supports the evaluation kit for the FSFR2100. It should be used in conjunction with the FSFR2100 datasheet as well as Fairchild application note AN-4151 and technical support team. Please visit Fairchild’s website at www.fairchildsemi.com.

1.1. Featured Fairchild Products

FSFR2100 is an integrated Pulse-Frequency-Modulation (PFM) controller and MOSFETs especially designed for Zero-Voltage-Switching (ZVS) resonant half-bridge converter topologies.

- Variable frequency control with 50% duty cycle for half-bridge resonant converter topology
- High efficiency through zero voltage switching (ZVS)
- Internal SuperFET®s with fast recovery type body diode ($t_{rr}=120\text{ns}$)
- Fixed dead time (350ns)
- Up to 300kHz operating frequency
- Pulse skipping for frequency limit (programmable) at light-load condition
- Simple remote ON/OFF control
- Various Protection functions: Over-Voltage Protection (OVP), Overload Protection (OLP), Over-Current Protection (OCP), Abnormal Over-Current Protection (AOCP), Internal Thermal Shutdown (TSD)

1.2. Power Supply Specification Table

Table 1. Power Supply Specifications

Description	Min.	Typ.	Max.	Units
Input Voltage (V_{IN}) ⁽¹⁾	340V	390V ⁽¹⁾	400V	V_{DC}
Output Voltage (V_{OUT})		24V		V_{DC}
Output Current (I_{OUT})	0		8	A_{DC}
Rated Output Power (P_O)			192	W

Note:

1. 20ms hold-up time for $V_{IN}=390V_{DC}$.

1.3. Schematic of the FSFR2100 Evaluation Board

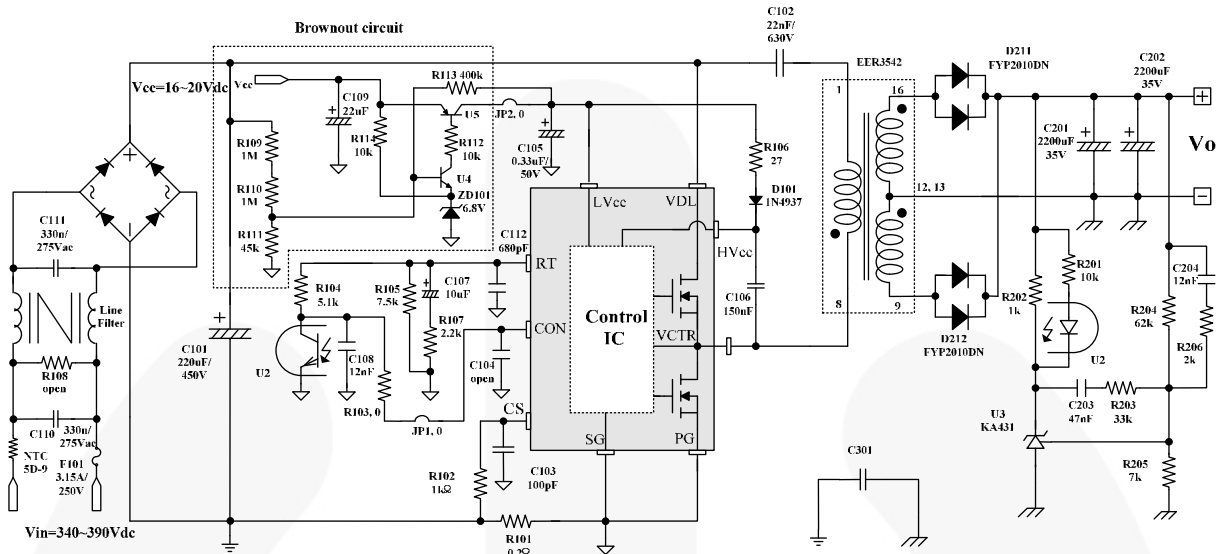

Figure 1. Schematic of FSFR2100 Evaluation Board (LLC Resonant Converter)

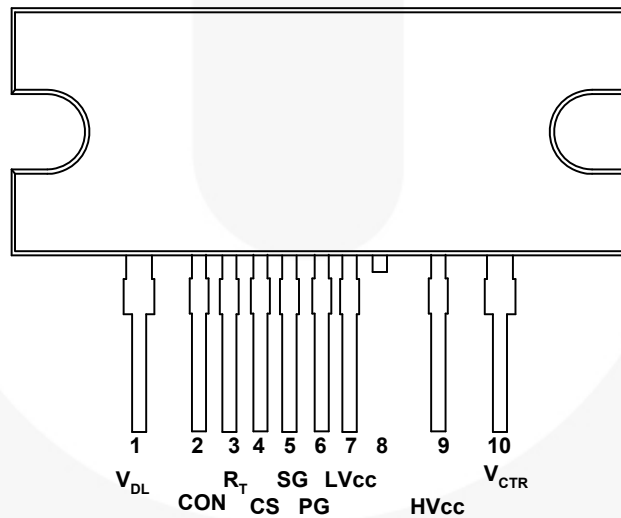

Figure 2. FSFR2100 Package Diagram (9-SIP)

1.4. Photographs of the FSFR2100 Evaluation Board

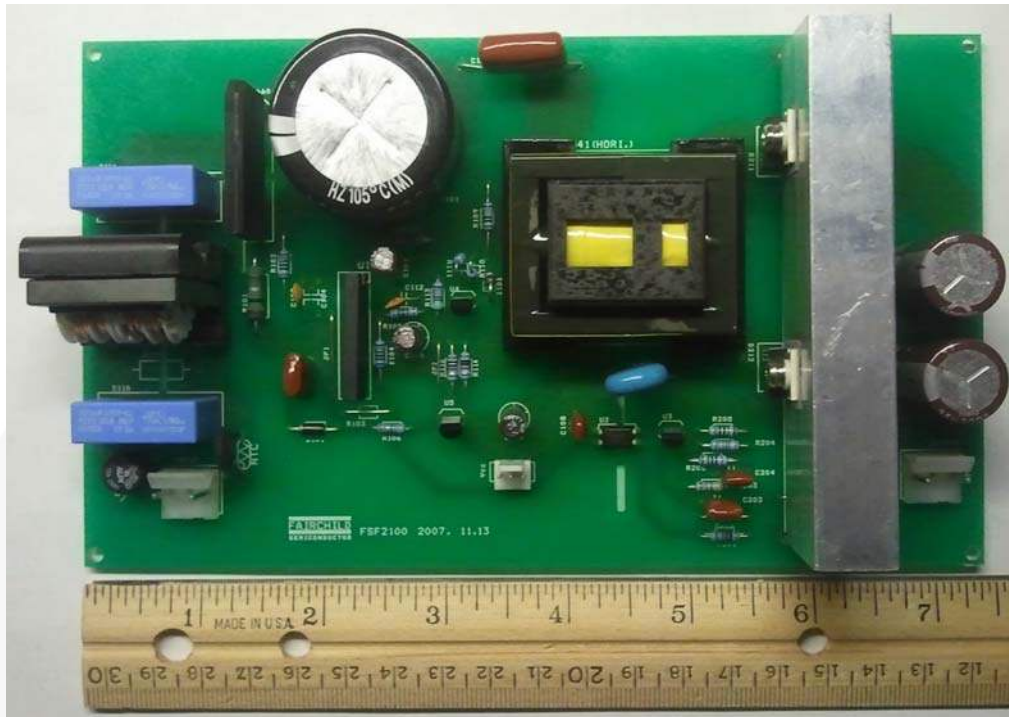

Figure 3. Top View of Evaluation Board

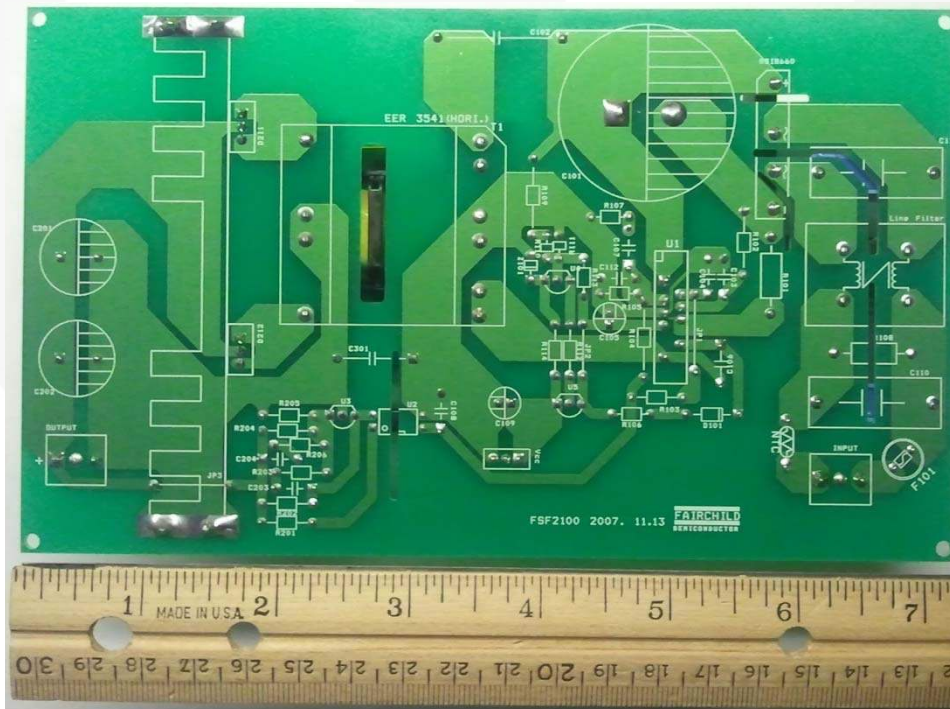

Figure 4. Bottom View of Evaluation Board

1.5. Bill of Materials

Item Number	Part Reference	Value	Note	Digi-Key	Manufacturer
1	C101	220 μ F/450V _{DC}	Electrolytic		Samyoung Electronics
2	C102	22nF/630V	Film		Samwha Electronics
3	C103	100pF	Ceramic		Samwha Electronics
4	C104	Open			
5	C105	0.33 μ F/50V	Electrolytic		Samyoung Electronics
6	C106	150nF	Film		Samwha Electronics
7	C107	10 μ F/50V	Electrolytic		Samyoung Electronics
8	C108	12nF	Film		Samwha Electronics
9	C109	22 μ F/50V	Electrolytic		Samyoung Electronics
10	C110, C111	330nF/275V _{AC}	Interference Suppression Film		Pilkor Electronics
11	C112	680pF	Ceramic		Samwha Electronics
12	C201, C202	2200 μ F/35V	Electrolytic		Samyoung Electronics
13	C203	47nF	Film		Samwha Electronics
14	C204	12nF	Film		Samwha Electronics
15	C301	3.3nF	AC Ceramic		Samwha Electronics
16	R101	0.2 Ω	1W	RS10.21%R-ND	Stackpole Electronics Inc
17	R102	1k Ω	1/4W	1.00KXTR-ND	YAGEO
18	R103	Short			
19	R104	5.1k Ω	1/4W	5.11KXTR-ND	YAGEO
20	R105	7.5k Ω	1/4W	7.50KXTR-ND	YAGEO
21	R106	27 Ω	1/4W	27.4XTR-ND	YAGEO
22	R107	2.2k Ω	1/4W	2.21KXTR-ND	YAGEO
23	R108	Open			
24	R109,R110	1M Ω	1/4W	1.00MXTR-ND	YAGEO
25	R111	45k Ω	1/4W	45.3KXTR-ND	YAGEO
26	R112	10k Ω	1/4W	10.0KXTR-ND	YAGEO
27	R113	400k Ω	1/4W	402KXTR-ND	YAGEO
28	R114, R201	10k Ω	1/4W	10.0KXTR-ND	YAGEO
29	R202	1k Ω	1/4W	1.00KXTR-ND	YAGEO
30	R203	33k Ω	1/4W	33.2KXTR-ND	YAGEO
31	R204	62k Ω	1/4W	61.9KXTR-ND	YAGEO
32	R205	7K Ω	1/4W	6.98KXTR-ND	YAGEO
33	R206	2k Ω	1/4W	2.00KXTR-ND	YAGEO
34	RT101	5D-9			
35	LF101	23mH			
36	D101	1N4937	600V/1A	1N4937-ND	Fairchild Semiconductor
37	D211, D212	FYP2010DN	100V/20A	FYP2010DNTU-ND	Fairchild Semiconductor
38	Z101	1N4736	6.8V	1N4736A-ND	Fairchild Semiconductor

Item Number	Part Reference	Value	Note	Digi-Key	Manufacturer
39	BD101	RBV606	Bridge	Diode	Fairchild Semiconductor
40	F101	3.15A/250V			
41	U1	FSFR2100	FPS™	FSFR2100-ND	Fairchild Semiconductor
42	U2	H11A817B	Opto-Coupler	H11Ab17B-ND	Fairchild Semiconductor
43	U3	KA431	Voltage Reference	KA431LZTA-ND	Fairchild Semiconductor
44	U4	2N2222	NPN Transistor	PN2222BU-ND	Fairchild Semiconductor
45	U5	2N2907	PNP Transistor	PN2907-ND	Fairchild Semiconductor

1.6. Transformer Specification

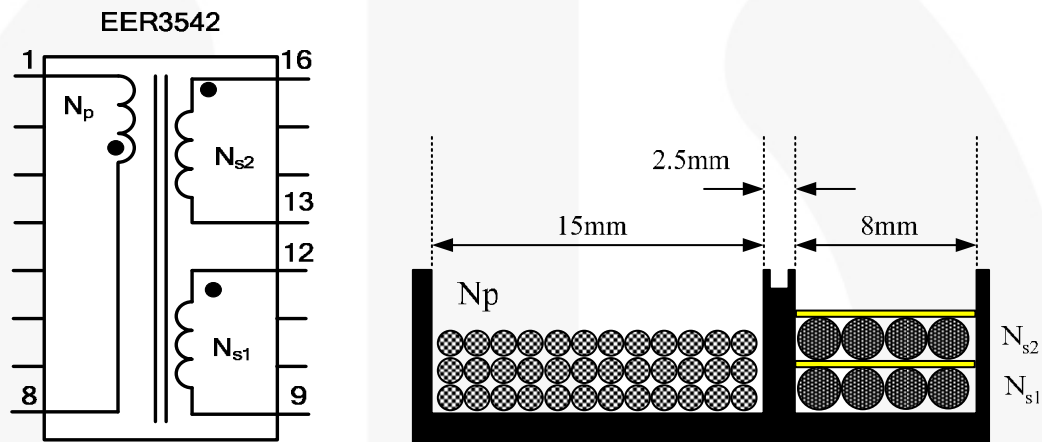

Figure 5. Transformer specification.

Table 2. Winding Specification

	Pin (S → F)	Wire	Turns	Winding Method
N_p	8 → 1	0.12φ×30 (Litz Wire)	36	Section Winding
N_{s1}	12 → 9	0.1φ×100 (Litz Wire)	4	Section Winding
N_{s2}	16 → 13	0.1φ×100 (Litz Wire)	4	Section Winding

Core: EER3542 ($A_e=107\text{mm}^2$)

Bobbin: EER3542 (Horizontal)

Table 3. Electrical Characteristics

	Pins	Specification	Remark
Primary-Side Inductance (L_P)	1 - 8	630μH ±5%	100kHz, 1V
Primary-Side Effective Leakage (L_R)	1 - 8	135μH Max.	Short one of the secondary windings

1.7. FSFR2100 (LLC) Printed Circuit Board Image

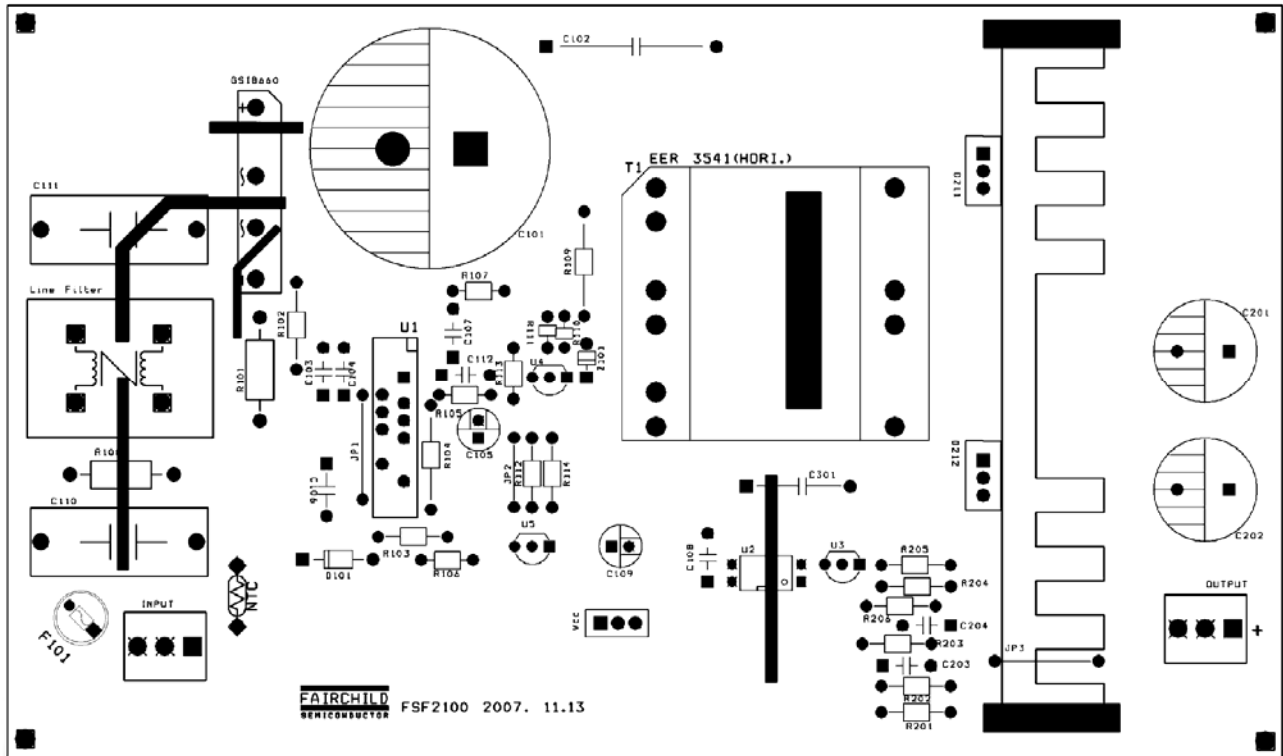

Figure 6. Top View of Evaluation Board PCB

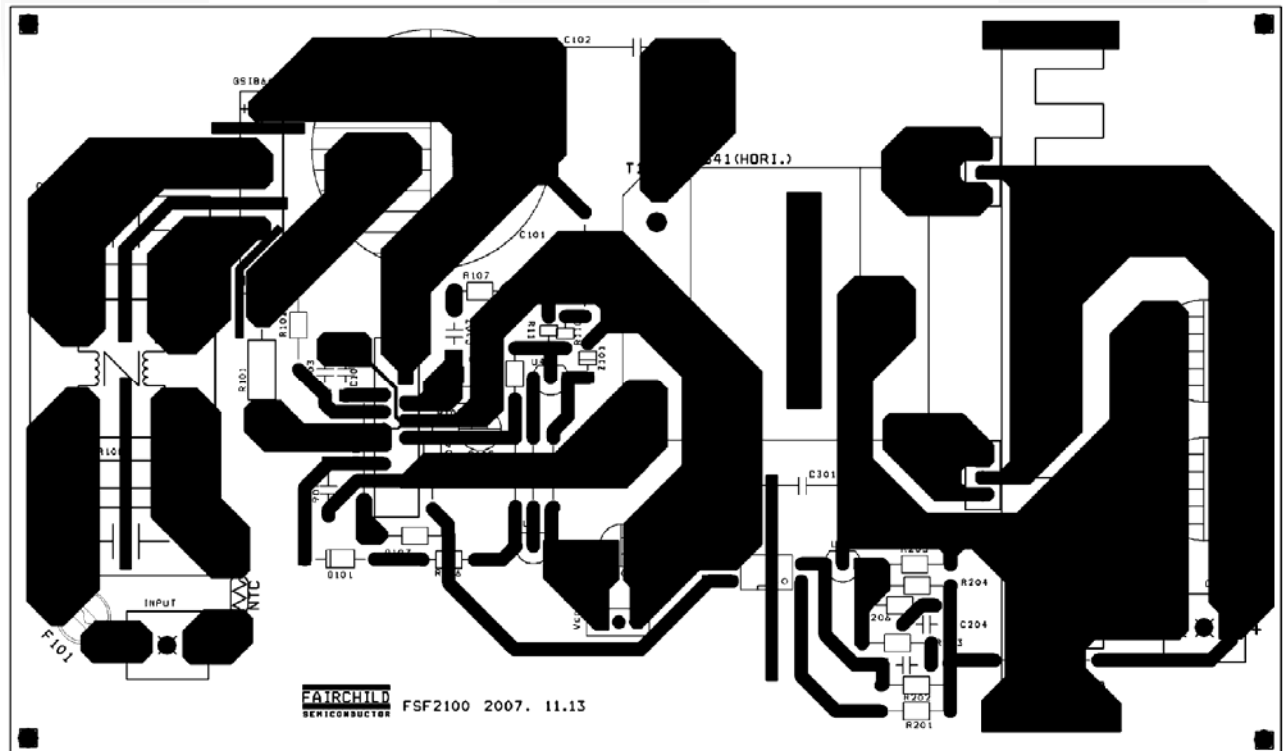

Figure 7. Bottom View of Evaluation Board PCB

2. Test Results

2.1. Primary-Side MOSFET Voltage and Current Waveforms

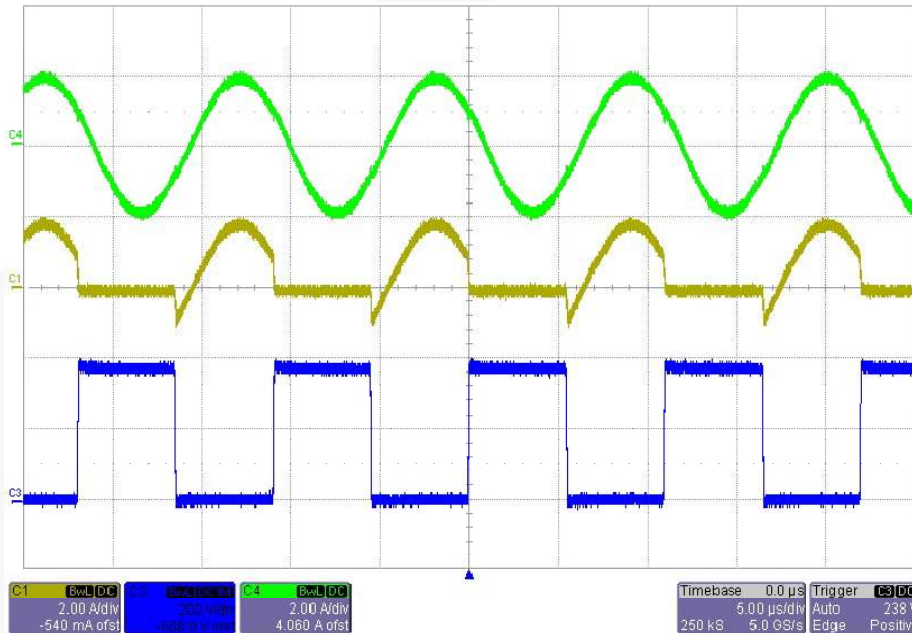

Figure 8. Operation Waveforms at Nominal Input Voltage [$V_{IN}=390V_{DC}$, $P_O=192W$ (24V/8A)]; C4: Transformer Primary-Side Current (2A/div); C1: Low-Side MOSFET Current (2A/div); C3: Low-Side MOSFET V_{DS} (200V/div), Time: 5 μ s/div

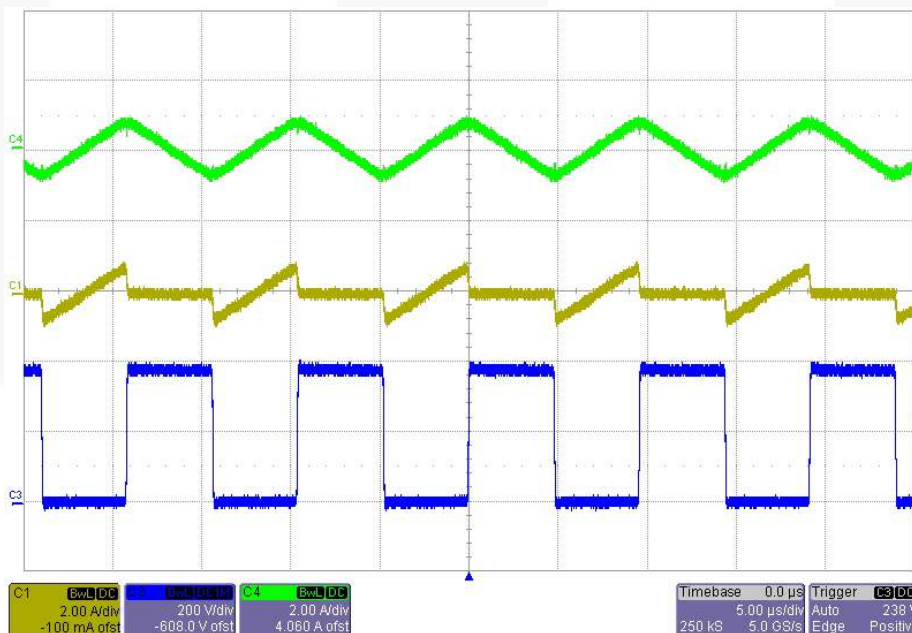

Figure 9. Operation Waveforms at Nominal Input Voltage [$V_{IN}=390V_{DC}$, $P_O=0W$ (24V/0A)]; C4: Transformer Primary-Side Current (2A/div); C1: Low-Side MOSFET Current (2A/div); C3: Low-Side MOSFET V_{DS} (200V/div), Time: 5 μ s/div

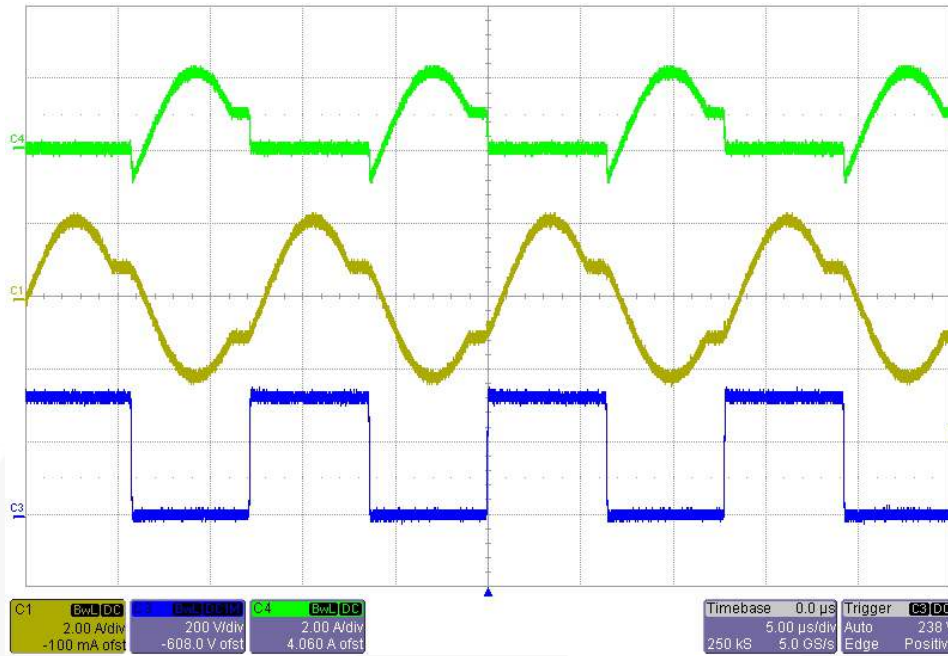

Figure 10. Operation Waveforms at Minimum Input Voltage [$V_{IN}=340V_{DC}$, $P_O=192W$ (24V/8A)]; C4: Transformer Primary-Side Current (2A/div); C1: Low-Side MOSFET Current (2A/div); C3: Low-Side MOSFET V_{DS} (200V/div), Time: 5μs/div

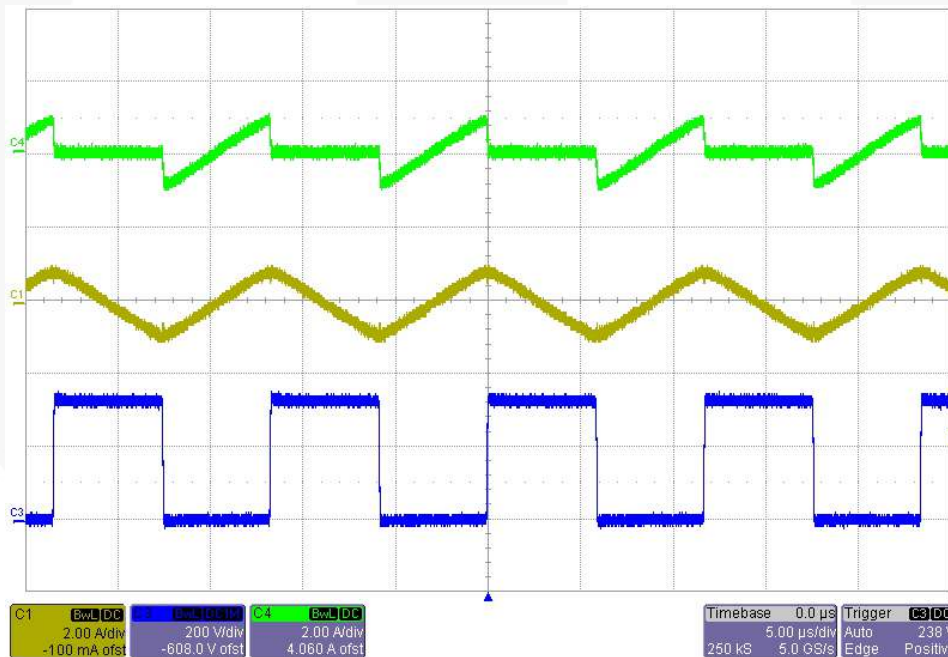

Figure 11. Operation Waveforms at Minimum Input Voltage [$V_{IN}=340V_{DC}$, $P_O=0W$ (24V/0A)]; C4: Transformer Primary-Side Current (2A/div); C1: Low-Side MOSFET Current (2A/div); C3: Low-Side MOSFET V_{DS} (200V/div), Time: 5μs/div

2.2. Secondary-Side Rectifier Diodes Voltage and Current Waveforms

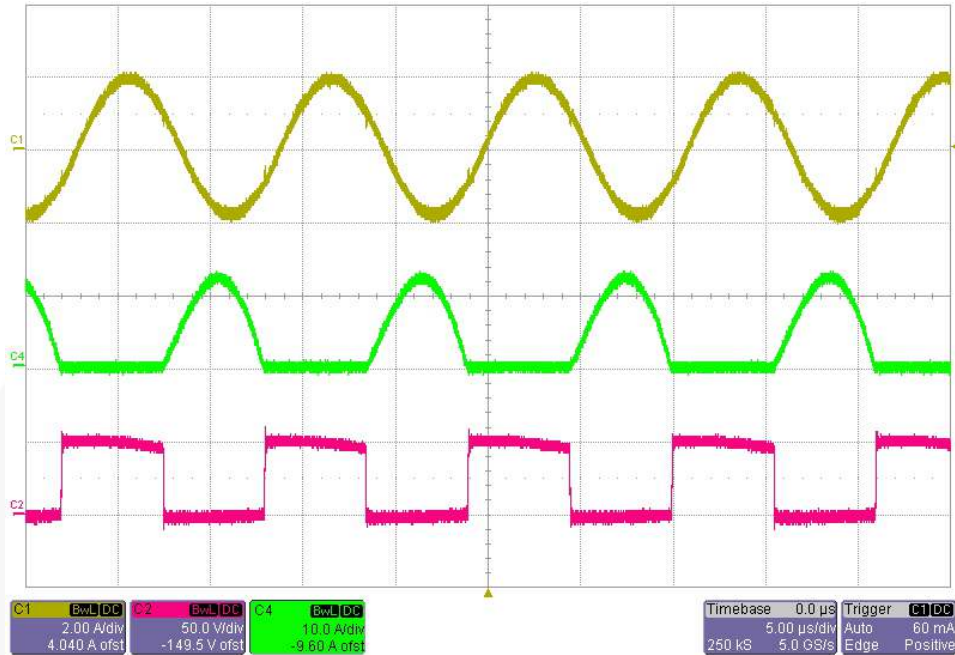

Figure 12. Operation Waveforms at Nominal Input Voltage [$V_{IN}=390V_{DC}$, $P_O=192W$ (24V/8A)]; C1: Transformer Primary-Side Current (2A/div); C4: Rectifier Diode (D211) Current (10A/div); C2: Rectifier Diode (D211) Voltage (50V/div), Time: 5 μ s/div

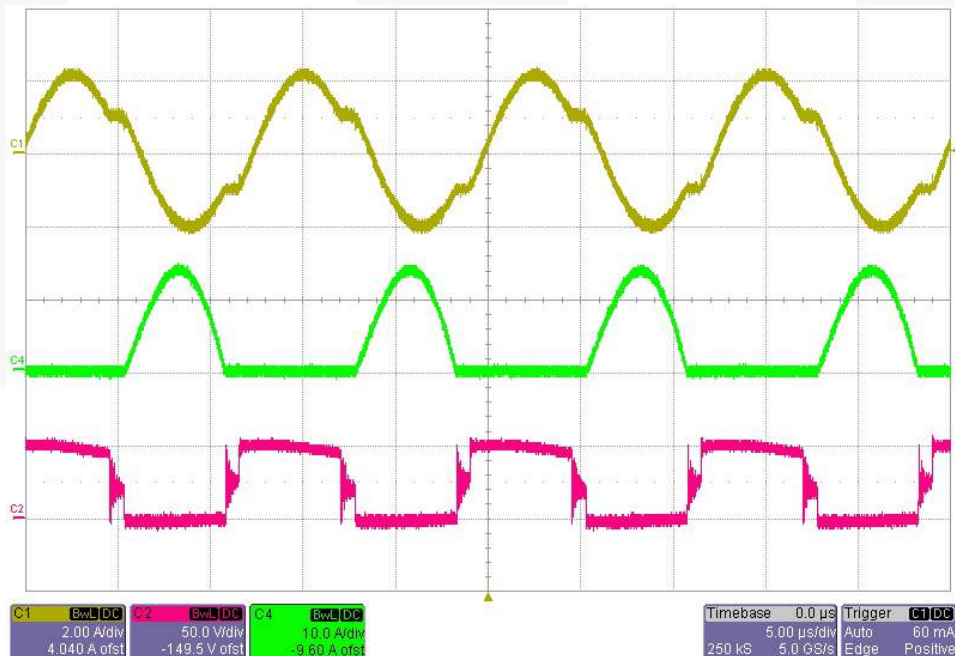

Figure 13. Operation Waveforms at Minimum Input Voltage [$V_{IN}=340V_{DC}$, $P_O=192W$ (24V/8A)]; C1: Transformer Primary-Side Current (2A/div); C4: Rectifier (D211) Diode Current (10A/div); C2: Rectifier Diode (D211) Voltage (50V/div), Time: 5 μ s/div

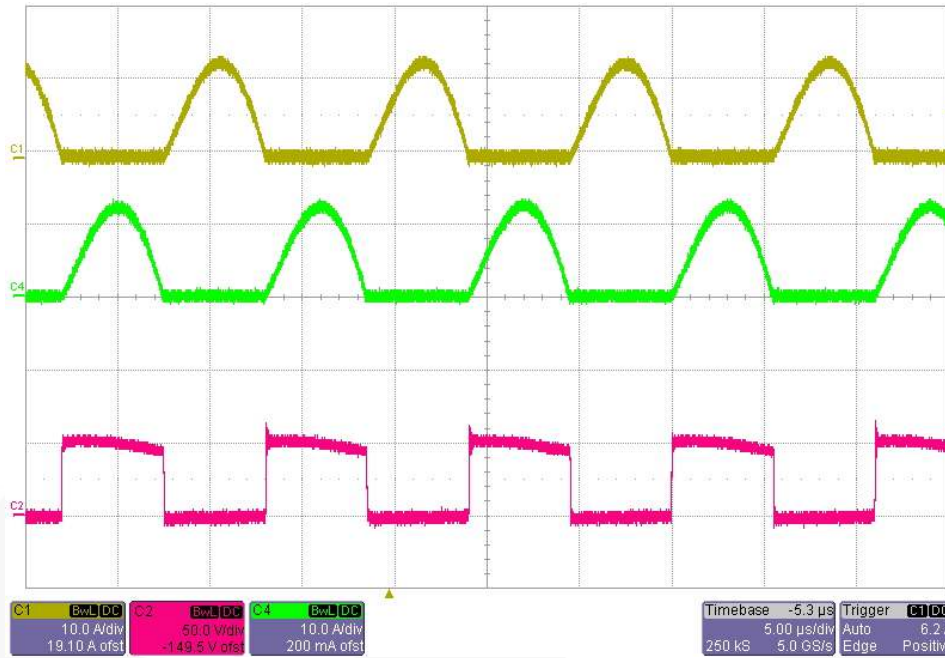

Figure 14. Operation Waveforms at Nominal Input Voltage [$V_{IN}=390V_{DC}$, $P_O=192W$ (24V/8A)]; C1: Rectifier Diode (D211) Current (10A/div); C4: Rectifier Diode (D212) Current (10A/div); C3: Rectifier Diode Voltage (50V/div), Time: 5μs/div

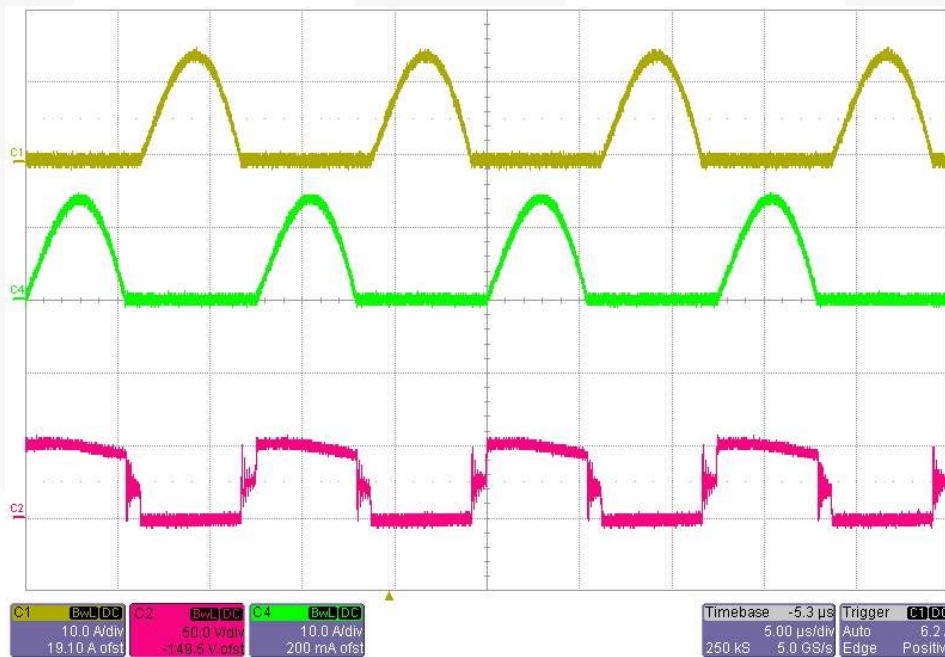

Figure 15. Operation Waveforms at Minimum Input Voltage [$V_{IN}=340V_{DC}$, $P_O=192W$ (24V/8A)]; C1: Rectifier Diode (D211) Current (10A/div); C4: Rectifier Diode (D212) Current (10A/div); C3: Rectifier Diode Voltage (50V/div), Time: 50μs/div

2.3. On/Off Waveforms

Figure 16 and Figure 17 show the soft-start waveforms at full-load and no-load conditions, respectively, for nominal input voltage condition. For these waveforms, the input DC bus is applied first, then V_{CC} for FSFR2100 is supplied.

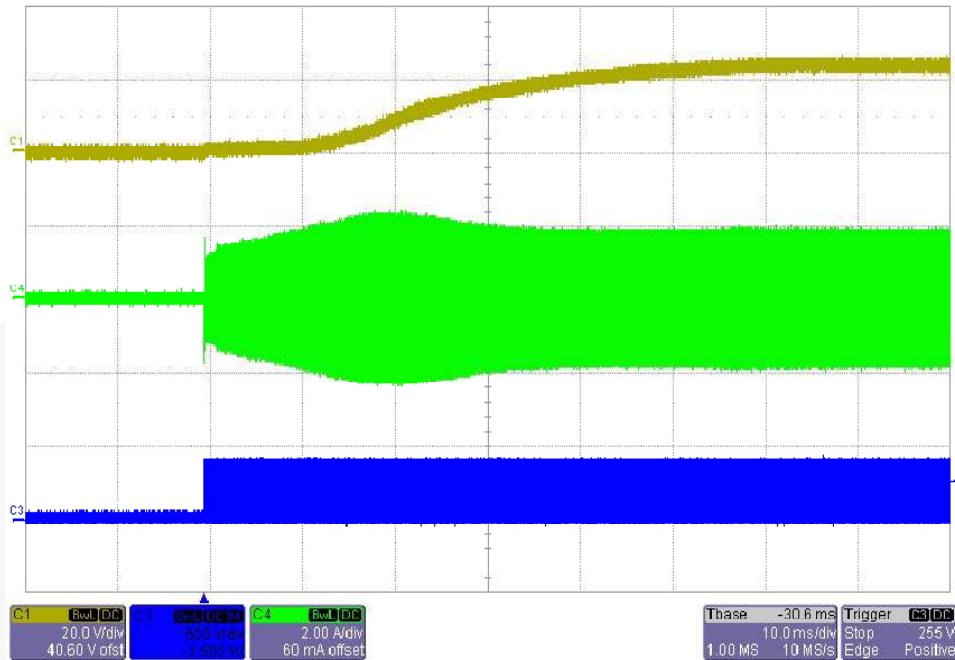

Figure 16. Startup Waveforms at Nominal Input Voltage [$V_{IN}=390V_{DC}$, $P_O=192W$ (24V/8A)]; C1: Output Voltage (20V/div); C4: Transformer Primary-Side Current (2A/div); C3: Low-Side MOSFET V_{DS} (500V/div), Time: 10ms/div

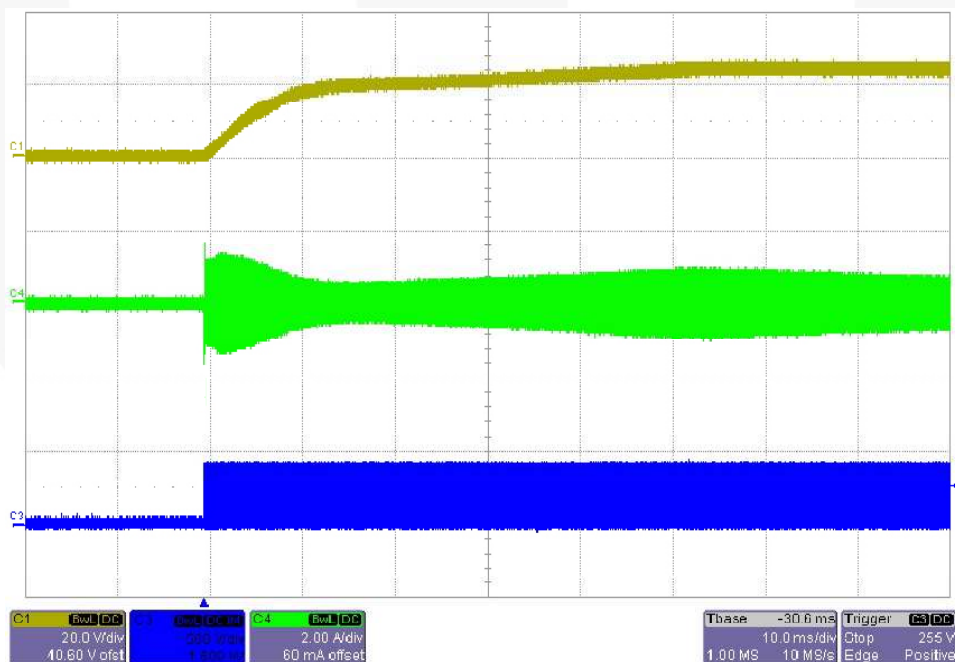

Figure 17. Startup Waveforms at Nominal Input Voltage [$V_{IN}=390V_{DC}$, $P_O=0W$ (24V/0A)]; C1: Output Voltage (20V/div); C4: Transformer Primary-Side Current (2A/div); C3: Low-Side MOSFET V_{DS} (500V/div), Time: 10ms/div

Figure 18 shows startup waveforms when V_{CC} of 18V is supplied first, then the input voltage source is applied. When the DC bus voltage reaches about 330V, the external brownout circuit connects V_{CC} supply voltage to F5FR2100 so that it starts up. Figure 19 shows shutdown waveforms when the input voltage source is turned off. When the DC bus voltage reaches about 260V, the external brownout circuit disconnects V_{CC} from F5FR2100 so that it stops operation.

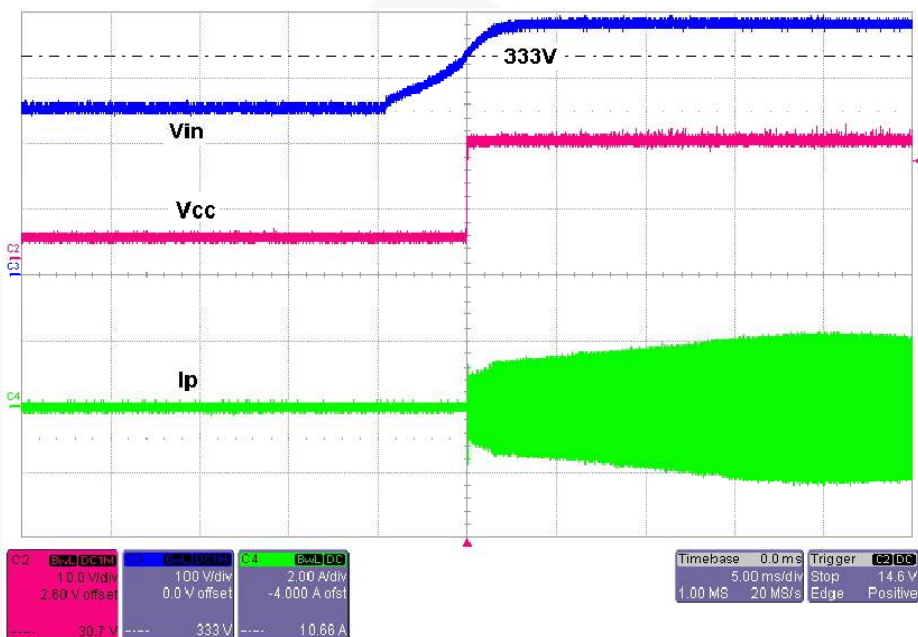

Figure 18. Power-On Waveforms at Nominal Input Voltage [$V_{IN}=390V_{DC}$, $P_O=192W$ (24V/8A)]; C1: Output Voltage (20V/div); C4: Transformer Primary-Side Current (2A/div); C3: Low-Side MOSFET V_{DS} (500V/div), Time: 5ms/div

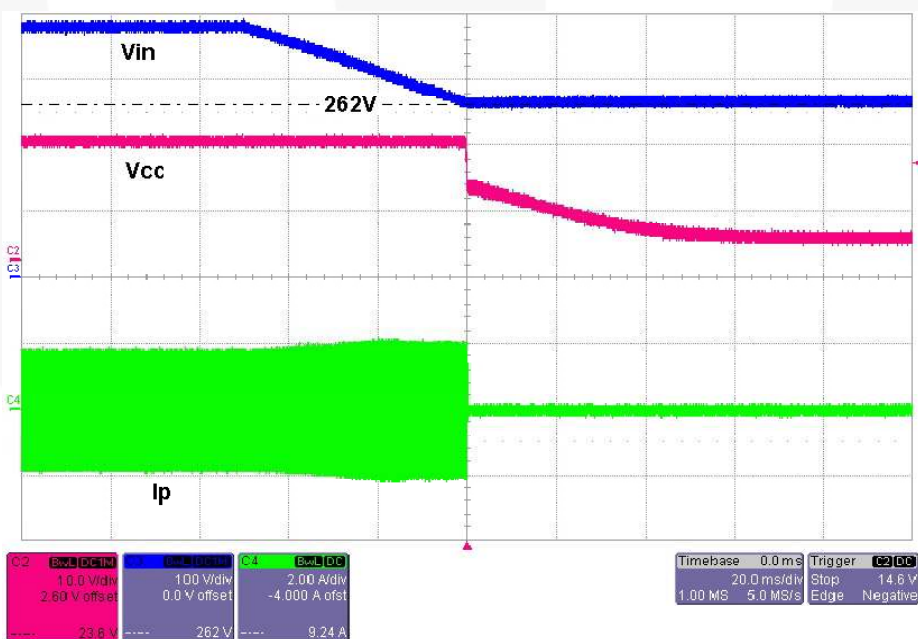

Figure 19. Power-Off Waveforms at Nominal Input Voltage [$V_{IN}=390V_{DC}$, $P_O=192W$ (24V/8A)]; C3: Input Voltage (100V/div); C2: V_{CC} Supply Voltage (10V/div); C4: Transformer Primary-Side Current (2A/div), Time: 20ms/div

2.4. Output Voltage Ripple

Figure 20 shows the output voltage ripple at nominal input voltage and full-load condition. The peak-to-peak ripple voltage is 0.5V, which is about 2% of the output voltage. Figure 21 shows the output voltage ripple with pulse load at nominal input voltage. The peak-to-peak ripple voltage is 0.8V, which is about 3% of the output voltage.

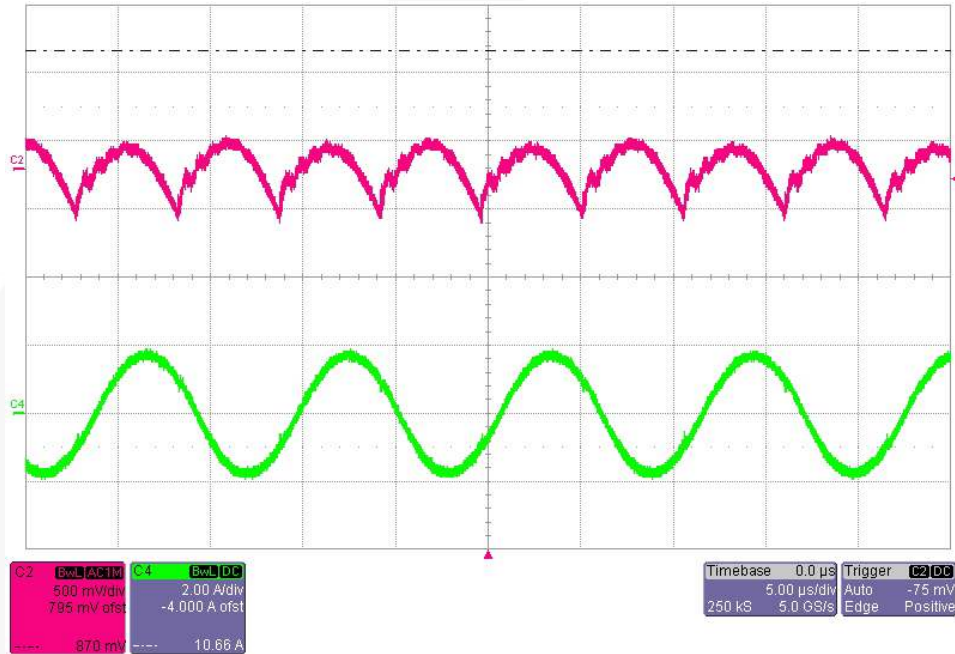

Figure 20. Output Voltage Ripple at Nominal Input Voltage [$V_{IN}=390V_{DC}$, $P_O=192W$ (24V/8A)]; C2: Output Voltage (500mV/div); C4: Transformer Primary-Side Current (2A/div), Time: 20ms/div

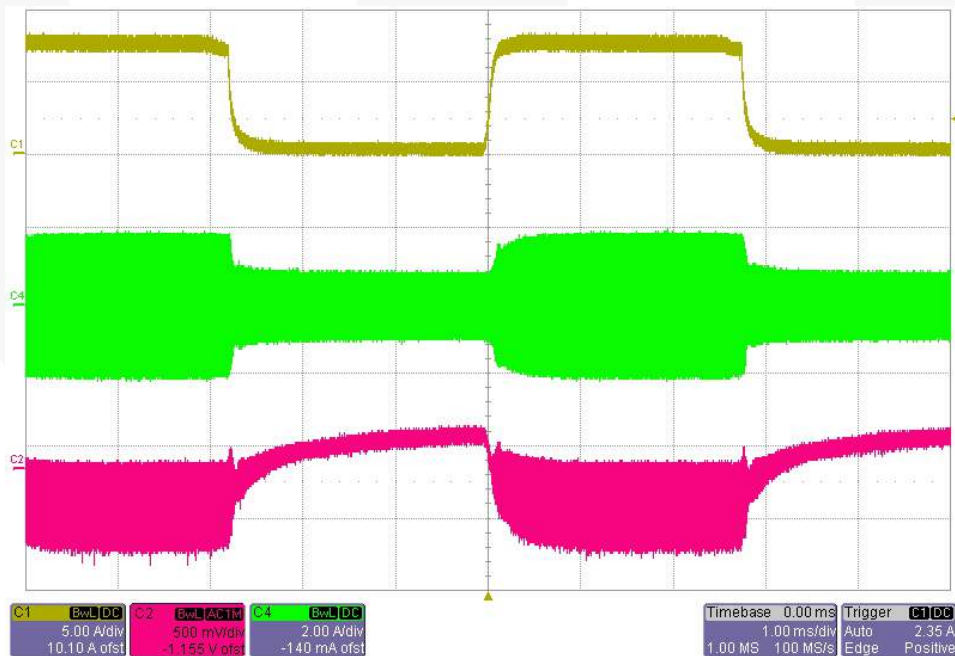
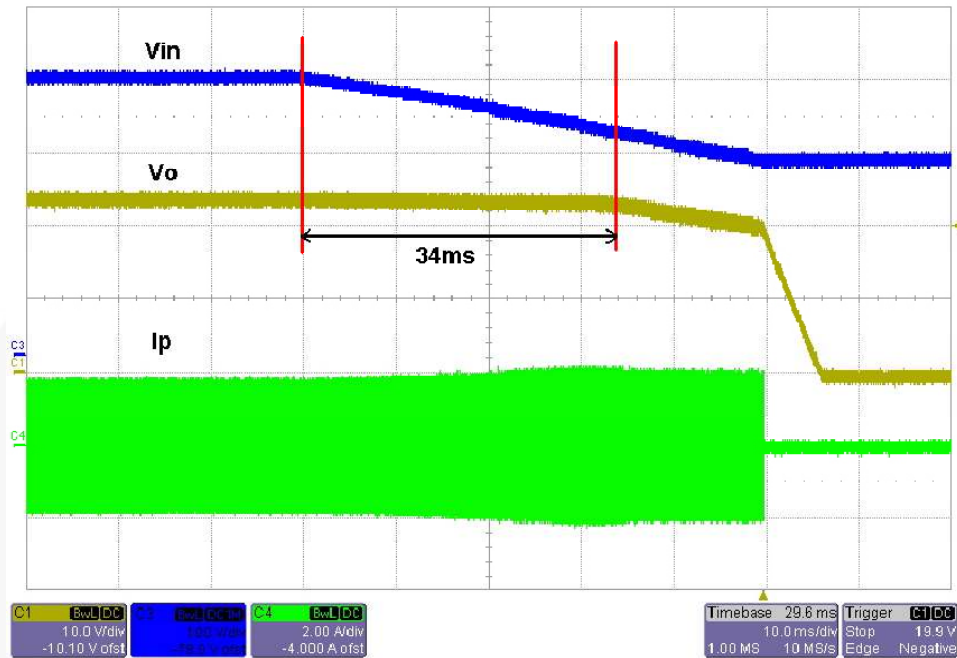

Figure 21. Output Voltage Ripple with Pulse Load Current at Nominal Input Voltage; [$V_{IN}=390V_{DC}$, ($I_O=0A \leftrightarrow 8A$, Slew Rate=50mA/ μ s, Duty=50%, $f=180Hz$)]; C1: Output Current (5A/div); C4: Transformer Primary-Side Current (2A/div); C2: Output Voltage Ripple, Time: 20ms/div

2.5. Hold-up Time Test

To see the holdup time, the input DC bus is disconnected while the converter operates at full-load condition. It can be observed that the output voltage is maintained for 34ms when the input DC bus is disconnected.



**Figure 22. Output Voltage Waveform after Turning Off Input Voltage [$V_{IN}=390V_{DC}$, $P_O=192W$ (24V/8A)];
C3: Input Voltage (100V/div); C1: Output Voltage (10V/div), C4: Transformer Primary-Side Current
(2A/div), Time: 10ms/div**

2.6. Protection Operation Waveforms

Figure 23 shows the overload protection waveforms. The output current increases from 8A to 16A. When the transformer primary-side current reaches its trip point of 3A, the over-current protection is triggered. Figure 24 shows the output-short protection waveforms. When the transformer primary-side current reaches its trip point of 3A, the over-current protection is triggered.

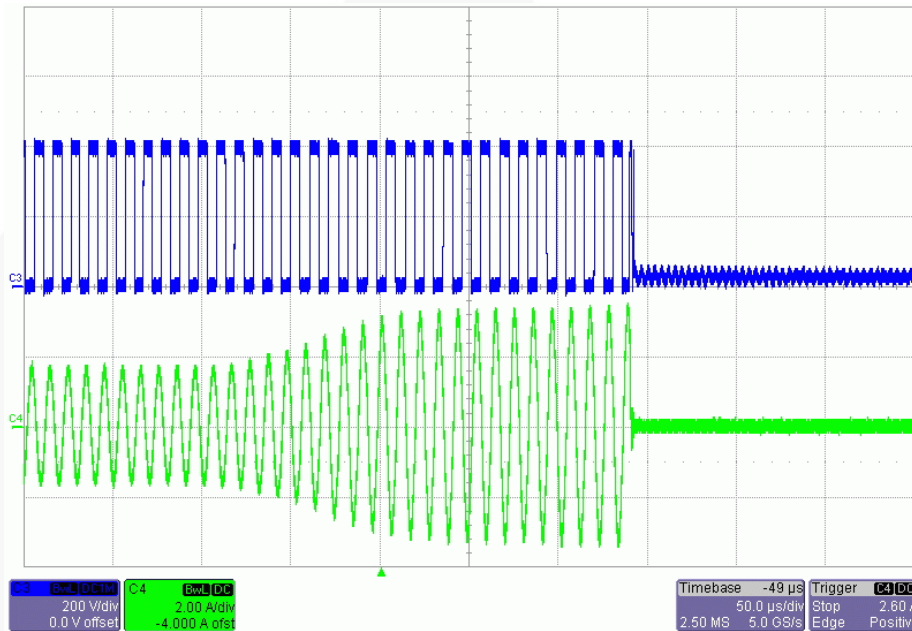

Figure 23. Protection Waveform at Overload Condition [$V_{IN}=390V_{DC}$, ($I_O=8A \rightarrow 16A$)]; C3: Low-Side Drain Voltage (200V/div); C4: Transformer Primary-Side Current (2A/div), Time: 50μs/div

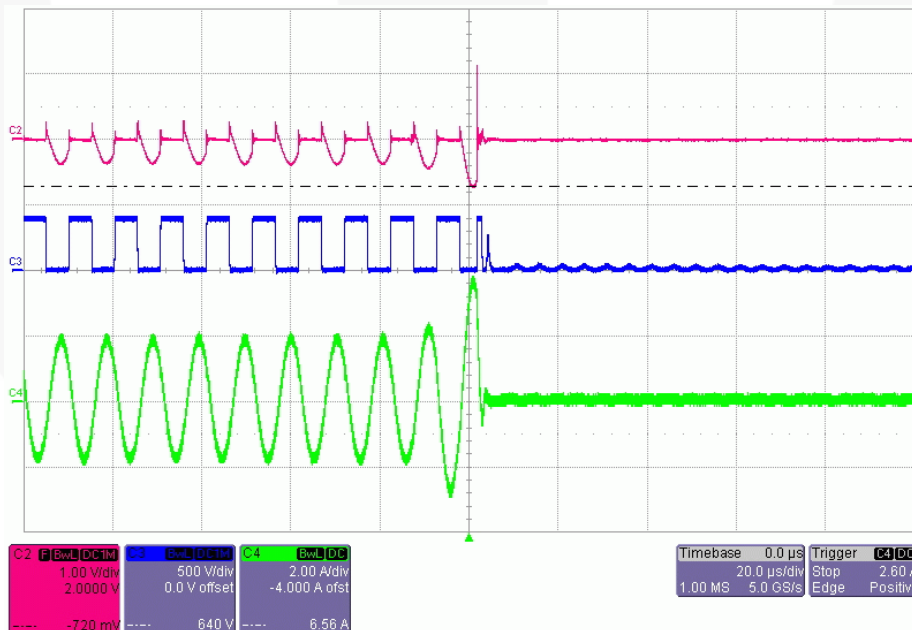

Figure 24. Protection Waveform at Output Short Condition [$V_{IN}=390V_{DC}$, ($I_O=8A \rightarrow \text{Short}$)]; C2: Current Sensing Pin (CS) Voltage (1V/div); C3: Low-Side MOSFET V_{DS} (500V/div); C4: Transformer Primary-Side Current (2A/div), Time: 20μs/div

2.7. Efficiency

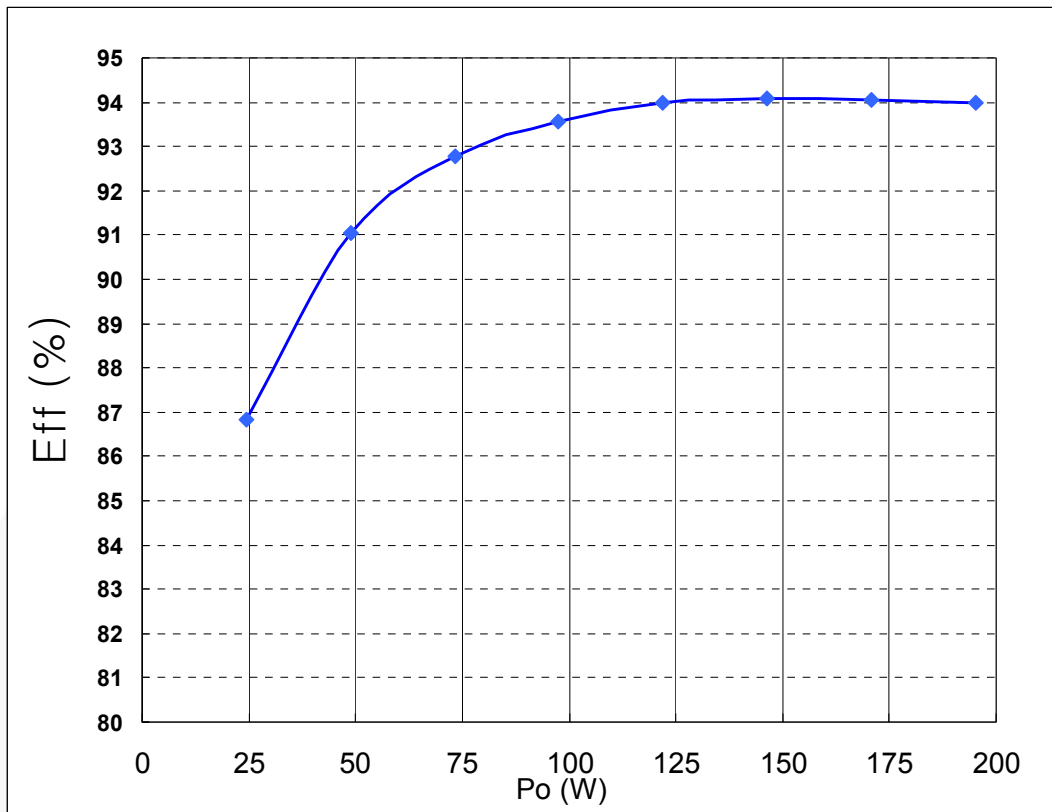

Figure 25. Measured Efficiency

3. Revision History

Rev.	Date	Description
1.0.0	January 2012	First draft
1.0.0	February 2012	Part number changed from FSED-FR2100-LCD-015 to FEBFSFR2100_D015v1

WARNING AND DISCLAIMER

Replace components on the Evaluation Board only with those parts shown on the parts list (or Bill of Materials) in the Users' Guide. Contact an authorized Fairchild representative with any questions.

This board is intended to be used by certified professionals, in a lab environment, following proper safety procedures. Use at your own risk. The Evaluation board (or kit) is for demonstration purposes only and neither the Board nor this User's Guide constitute a sales contract or create any kind of warranty, whether express or implied, as to the applications or products involved. Fairchild warrants that its products meet Fairchild's published specifications, but does not guarantee that its products work in any specific application. Fairchild reserves the right to make changes without notice to any products described herein to improve reliability, function, or design. Either the applicable sales contract signed by Fairchild and Buyer or, if no contract exists, Fairchild's standard Terms and Conditions on the back of Fairchild invoices, govern the terms of sale of the products described herein.

DISCLAIMER

FAIRCHILD SEMICONDUCTOR RESERVES THE RIGHT TO MAKE CHANGES WITHOUT FURTHER NOTICE TO ANY PRODUCTS HEREIN TO IMPROVE RELIABILITY, FUNCTION, OR DESIGN. FAIRCHILD DOES NOT ASSUME ANY LIABILITY ARISING OUT OF THE APPLICATION OR USE OF ANY PRODUCT OR CIRCUIT DESCRIBED HEREIN; NEITHER DOES IT CONVEY ANY LICENSE UNDER ITS PATENT RIGHTS, NOR THE RIGHTS OF OTHERS.

LIFE SUPPORT POLICY

FAIRCHILD'S PRODUCTS ARE NOT AUTHORIZED FOR USE AS CRITICAL COMPONENTS IN LIFE SUPPORT DEVICES OR SYSTEMS WITHOUT THE EXPRESS WRITTEN APPROVAL OF THE PRESIDENT OF FAIRCHILD SEMICONDUCTOR CORPORATION.

As used herein:

1. Life support devices or systems are devices or systems which, (a) are intended for surgical implant into the body, or (b) support or sustain life, or (c) whose failure to perform when properly used in accordance with instructions for use provided in the labeling, can be reasonably expected to result in significant injury to the user.
2. A critical component is any component of a life support device or system whose failure to perform can be reasonably expected to cause the failure of the life support device or system, or to affect its safety or effectiveness.

ANTI-COUNTERFEITING POLICY

Fairchild Semiconductor Corporation's Anti-Counterfeiting Policy. Fairchild's Anti-Counterfeiting Policy is also stated on our external website, www.fairchildsemi.com, under Sales Support.

Counterfeiting of semiconductor parts is a growing problem in the industry. All manufacturers of semiconductor products are experiencing counterfeiting of their parts. Customers who inadvertently purchase counterfeit parts experience many problems such as loss of brand reputation, substandard performance, failed applications, and increased cost of production and manufacturing delays. Fairchild is taking strong measures to protect ourselves and our customers from the proliferation of counterfeit parts. Fairchild strongly encourages customers to purchase Fairchild parts either directly from Fairchild or from Authorized Fairchild Distributors who are listed by country on our web page cited above. Products customers buy either from Fairchild directly or from Authorized Fairchild Distributors are genuine parts, have full traceability, meet Fairchild's quality standards for handling and storage and provide access to Fairchild's full range of up-to-date technical and product information. Fairchild and our Authorized Distributors will stand behind all warranties and will appropriately address any warranty issues that may arise. Fairchild will not provide any warranty coverage or other assistance for parts bought from Unauthorized Sources. Fairchild is committed to combat this global problem and encourage our customers to do their part in stopping this practice by buying direct or from authorized distributors.

EXPORT COMPLIANCE STATEMENT

These commodities, technology, or software were exported from the United States in accordance with the Export Administration Regulations for the ultimate destination listed on the commercial invoice. Diversion contrary to U.S. law is prohibited.

U.S. origin products and products made with U.S. origin technology are subject to U.S. Re-export laws. In the event of re-export, the user will be responsible to ensure the appropriate U.S. export regulations are followed.