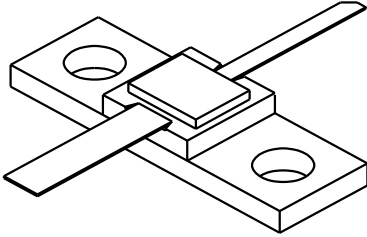

2224-6L

6 Watts, 22 Volts, Class C
Microwave 2200-2400 MHz

<p>GENERAL DESCRIPTION</p> <p>The 2224-6L is a COMMON BASE transistor capable of providing 6 Watts, Class C output power over the band 2200-2400 MHz. The transistor includes input prematching for full Broadband capability. Gold metalization and diffused ballasting are used to provide high reliability and supreme ruggedness. The transistor uses a fully hermetic High Temperature Solder Sealed package.</p>	<p>CASE OUTLINE 55LV STYLE 1</p> 													
<p>ABSOLUTE MAXIMUM RATINGS</p> <p>Maximum Power Dissipation @ 25°C 22 Watts</p> <p>Maximum Voltage and Current</p> <table style="width: 100%; border: none;"> <tr> <td style="width: 15%;">BVces</td> <td style="width: 45%;">Collector to Emitter Voltage</td> <td style="width: 40%; text-align: right;">40 Volts</td> </tr> <tr> <td>BVebo</td> <td>Emitter to Base Voltage</td> <td style="text-align: right;">3.5 Volts</td> </tr> <tr> <td>Ic</td> <td>Collector Current</td> <td style="text-align: right;">1.25 Amps</td> </tr> </table> <p>Maximum Temperatures</p> <table style="width: 100%; border: none;"> <tr> <td style="width: 45%;">Storage Temperature</td> <td style="text-align: right;">- 40 to + 200°C</td> </tr> <tr> <td>Operating Junction Temperature</td> <td style="text-align: right;">+ 200°C</td> </tr> </table>	BVces	Collector to Emitter Voltage	40 Volts	BVebo	Emitter to Base Voltage	3.5 Volts	Ic	Collector Current	1.25 Amps	Storage Temperature	- 40 to + 200°C	Operating Junction Temperature	+ 200°C	
BVces	Collector to Emitter Voltage	40 Volts												
BVebo	Emitter to Base Voltage	3.5 Volts												
Ic	Collector Current	1.25 Amps												
Storage Temperature	- 40 to + 200°C													
Operating Junction Temperature	+ 200°C													

ELECTRICAL CHARACTERISTICS @ 25 °C

SYMBOL	CHARACTERISTICS	TEST CONDITIONS	MIN	TYP	MAX	UNITS
Pout	Power Out	F = 2200-2400 MHz	6.0			Watts
Pin	Power Input	Vcc = 22 Volts			1.2	Watts
Pg	Power Gain		7.0			dB
η_c	Efficiency			40		%
VSWR	Load Mismatch Tolerance	Pout = 6.0 Watts			10:1	

BVces	Collector to Emitter Breakdown	Ic = 10 mA	40			Volts
BVebo	Emitter to Base Breakdown	Ie = 5 mA	3.5			Volts
Hfe	Current Gain	Vce = 5 V, Ic = 1 A	20		120	
Cob	Output Capacitance	Vcb = 22 F = 1 MHz		7		pF
θ_{jc}	Thermal Resistance	Tc = 25°C			8.0	°C/W

Initial Issue December 15, 1994

GHz TECHNOLOGY INC. RESERVES THE RIGHT TO MAKE CHANGES WITHOUT FURTHER NOTICE. GHz RECOMMENDS THAT BEFORE THE PRODUCT(S) DESCRIBED HEREIN ARE WRITTEN INTO SPECIFICATIONS, OR USED IN CRITICAL APPLICATIONS, THAT THE PERFORMANCE CHARACTERISTICS BE VERIFIED BY CONTACTING THE FACTORY.

BROADBAND POWER OUT & RETURN LOSS

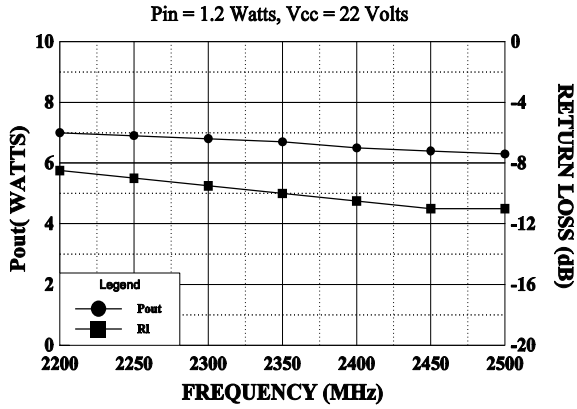

POWER OUTPUT vs POWER INPUT

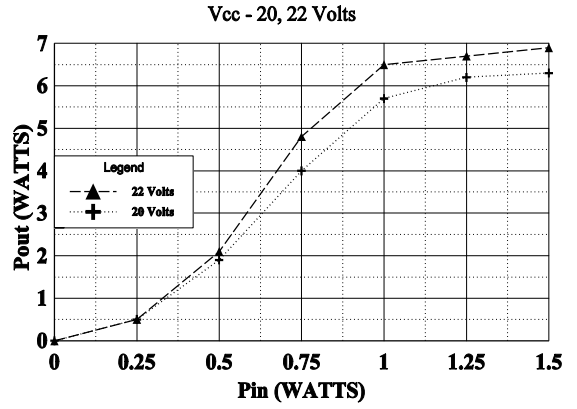

EFFICIENCY vs FREQUENCY

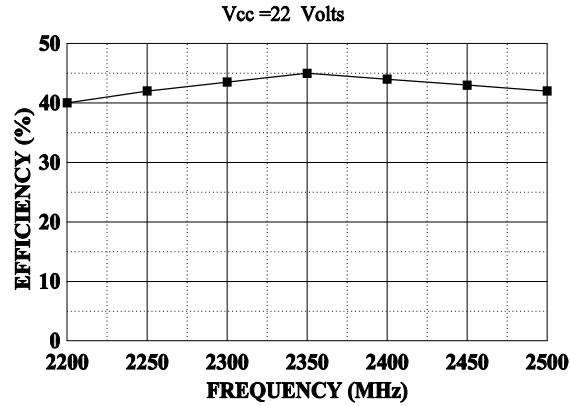

INPUT IMPEDANCE

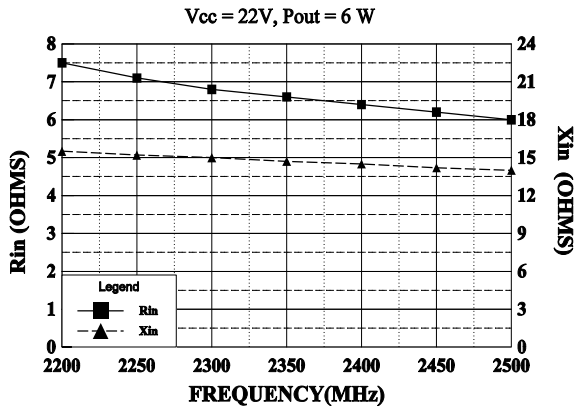

LOAD IMPEDANCE

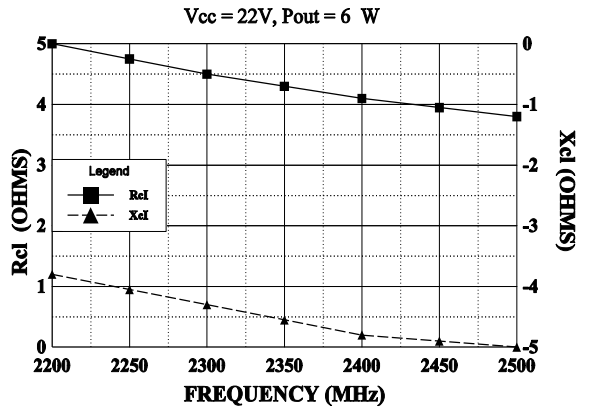

REVISIONS

ZONE	REV	DESCRIPTION	DATE	APPROVED
------	-----	-------------	------	----------

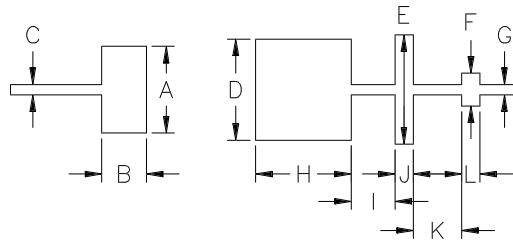

DIM	INCHES
A	.475
B	.245
C	.053
D	.555
E	.600
F	.180
G	.053
H	.525
I	.240
J	.100
K	.265
L	.100

2224-6L TEST CIRCUIT

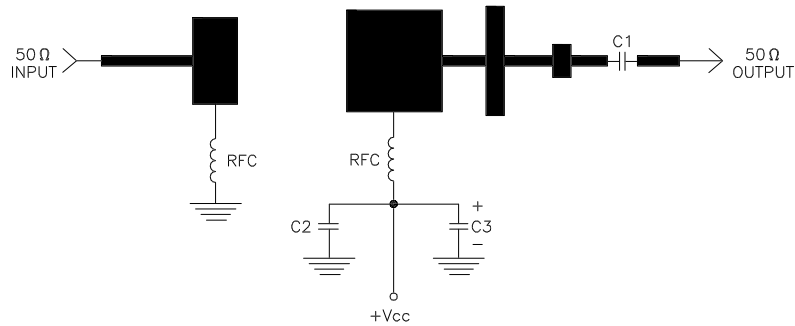

DIELECTRIC = 20 MIL THICK TFE Er = 2.43
 C1, C2 = 62pF CHIP ATC "B"
 C3 = 10 MFD @ 35V
 RFC = 4 turns #22 wire 1/16" I.D.



CAGE OPJR2	DWG NO. 2224-6L	REV A
SCALE 1/1	SHEET	