

TPS43331EVM

Contents

1	Introduction	2
2	Setup	2
2.1	2.1. Input/Output Connector Descriptions	2
2.2	2.2. Setup	5
2.3	2.3. Operation	5
3	Board Layout	5
4	Schematics and Bill of Materials	9

List of Figures

1	Control Switch Diagram	3
2	Reverse Battery Protection Diode Bypass Jumper Settings	4
3	MSP430 Regulator Jumper Settings	4
4	I ² C Interface Jumper Settings	5
5	Top Assembly Layer	6
6	Top Layer Routing	7
7	Bottom Assembly Layer	7
8	Bottom Layer Routing	8
9	Internal Power Plane Layer	8
10	Internal Ground Plane Layer	8
11	TPS43331EVM Schematic	10
12	MSP430 Controller Schematic	10

List of Tables

1	Device and Package Configurations	2
2	SYNCH Frequency Select and Enable Switch Settings	3
3	Switched Regulator 1 Switch Setting	3
4	Switched Regulator 2 Switch Setting	4
5	Switched Linear Regulator Switch Setting	4
6	High-Side Driver Switch Setting	4
7	TPS43331EVM Bill of Materials	11

1 Introduction

The Texas Instruments TPS43331EVM evaluation module (EVM) helps designers evaluate the operation and performance of the TPS43331 Switch Mode Power Supply – Multiple-output voltage regulator.

Table 1. Device and Package Configurations

CONVERTER	IC	PACKAGE
U4	TPS43331QDAPRQ1	DAP-38

2 Setup

This section describes the jumpers and connectors on the EVM as well and how to properly connect, set up and use the TPS43331EVM.

2.1 2.1. Input/Output Connector Descriptions

J1 – Input is the power input terminal for the EVM. The terminal block provides a power (VIN) and ground (GND) connection.

J2 – Output is the output terminal for the TPS43331 Standby Linear. The terminal block provides a power (VSTBY) and ground (GND) connection.

J3 – Output is the output terminal for the TPS43331 Switched Linear Regulator. The terminal block provides a power (VLR) and ground (GND) connection.

J4 – Output is the regulated output voltage for converter 1 on the TPS43331. The terminal block provides a power (VOUT1) and ground (GND) connection.

J5 – Output is the regulated output voltage for converter 2 on the TPS43331. The terminal block provides a power (VOUT2) and ground (GND) connection.

J6 – Output is the output terminal for the TPS43331 high-side driver switch. The terminal block provides a power (HSD) and ground (GND) connection.

J7 – Input is the input terminal to apply an external I²C interface to the TPS43331. The terminal block provides SCL, SDA, and GND connections. The SCL and SDA jumpers should be removed if the external I²C interface is used.

J8 – Input is the input terminal to program the MSP430 controller device. The user should not need to use this connector.

Test Points

- EN – Enable input for Switcher 1
- CLK – External clock input
- GND (x6) – Ground
- HSD – High-side driver
- PH1 – Switcher 1 phase pin
- PH2 – Switcher 2 phase pin
- $\overline{\text{RST}}$ – Reset warning output
- VBAT – Power Input
- VBATW – Vbat warning output
- VIN – Power input after the reverse battery protection diode
- VLR – Switched linear regulator output
- VOUT1 – Switcher 1 output
- VOUT2 – Switcher 2 output
- VSTBY – Standby linear regulator output

S3 – Control Switch is a seven position DIP switch used to set the operating frequency, enable the external clock and control Switcher 1, Switcher 2, the switched linear regulator, and the high-side switch.



Figure 1. Control Switch Diagram

FS0, FS1, and CLKEN – Set the frequency and to enable the preprogrammed external clock from the MSP430 to the TPS43331 Synch input. The TPS43331 internal clock source is also used if the No Clock setting is selected. The user can also apply an optional user defined external clock to the CLK test point, if the User Defined setting is selected.

Table 2. SYNCH Frequency Select and Enable Switch Settings

Clock Frequency	FS0	FS1	CLKEN
No Clock	Position 2	Position 2	Don't care
250 kHz	Position 1	Position 2	Position 2
333 kHz	Position 2	Position 1	Position 2
400 kHz	Position 1	Position 1	Position 2
User Defined	Don't care	Don't care	Position 1

The frequency is set when power is applied to the EVM and cannot be changed after power-up. Set the switch to the desired frequency before applying power to the EVM.

The jumpers can also be used to disable the MSP430 during EMC testing. The procedure to disable the MSP430 is:

1. Set FS0 and FS1 to the No Clock setting before power up.
2. Apply power to the EVM.
3. Set the regulator conditions on the TPS43331 to be tested.
4. Set FS0 and FS1 to Position 1 to disable the MSP430.

NOTE: Power must be cycled to the EVM to turn the MSP430 back on and send new commands to the TPS43331 after EMC testing has been completed.

SW1EN – Used to control Switched Regulator 1 on the TPS43331. The switch can be moved at any time after power has been applied to the EVM. All regulators (except for the standby regulator) are disabled if Switcher 1 is disabled.

Table 3. Switched Regulator 1 Switch Setting

Switcher 1	SW1EN
Disabled	Position 1
Enabled	Position 2

SW2EN – Used to control Switched Regulator 2 on the TPS43331. The switch can be moved at any time after power has been applied to the EVM.

Table 4. Switched Regulator 2 Switch Setting

Switcher 2	SW2EN
Disabled	Position 1
Enabled	Position 2

VLREN – Used to control the switched linear regulator on the TPS43331. The switch can be moved at any time after power has been applied to the EVM.

Table 5. Switched Linear Regulator Switch Setting

Switched Linear	VLREN
Disabled	Position 1
Enabled	Position 2

HSDEN – Used to control the high-side switch on the TPS43331. The switch can be moved at any time after power has been applied to the EVM.

Table 6. High-Side Driver Switch Setting

High-Side Driver	HSDEN
Disabled	Position 1
Enabled	Position 2

JP1 – Zener Bypass is the jumper used to bypass the reverse battery protection diode.

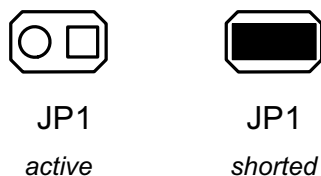

Figure 2. Reverse Battery Protection Diode Bypass Jumper Settings

JP2 – MSP430 Power is the jumper used to enable the power supply to the MSP430. Power must be enabled to the MSP430 to control the TPS43331. The MSP430 can be disabled and maintain the state of the its outputs for EMC testing using the procedure listed under the SYNCH jumper settings, but power must be supplied to the MSP430.

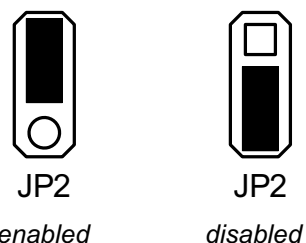

Figure 3. MSP430 Regulator Jumper Settings

SCL, SDA – Jumpers used to disconnect the MSP430 from the I²C Interface on the TPS43331. External I²C interface signals can be applied using J8.



Figure 4. I²C Interface Jumper Settings

2.2 Setup

The input voltage range for the converter is 2 V to 30 V.

2.3 Operation

For proper operation of the TPS43331, S3, JP1, JP2, SCL and SDA should be properly configured. The following are the recommended settings, using the switch and shorting blocks:

- FS0 250 kHz
- FS1 250 kHz
- CLKEN enabled
- SW1EN disabled
- SW2EN disabled
- VLREN disabled
- HSDEN disabled
- JP1 active
- JP2 enabled
- SCL to MSP430
- SDA to MSP430

In this configuration, the regulators do not turn on when power is applied. Enable regulators using S3 after power has been applied to the EVM.

FS0 and FS1 select the frequency of the clock input to the SYNCH pin: 400 kHz, 333 kHz, 250 kHz, or no clock. CLKEN connects the clock signal to the SYNCH pin on the TPS43331. SW1EN turns switcher 1 on or off, disabled or enabled. SW2EN turns switcher 2 on or off, disabled or enabled. VLREN turns the switched linear regulator on or off, disabled or enabled. HSDEN turns high-side driver switch on or off, disabled. or enabled. JP1 removes the reverse battery protection diode from the circuit, active or shorted. JP2 controls the power to the MSP430, disabled or enabled. SCL / SDA connect the I²C interface of the MSP430 to the I²C interface of the TPS43331, external or MSP430.

Regulator Configuration

- Switcher 1: 5.0 V
- Switcher 2: 3.3 V
- VLR: 8.0 V
- VSTBY: 2.5 V

3 Board Layout

[Figure 5](#), [Figure 6](#), [Figure 7](#), [Figure 8](#), [Figure 9](#), and [Figure 10](#) show the board layout for the TPS43331EVM PWB.

The TPS43331 is high efficiency but does dissipate power. The PowerPAD™ package offers an exposed thermal pad to enhance thermal performance. This must be soldered to the copper landing on the PCB for optimal performance. The PCB provides 1-oz copper planes on the top and bottom to dissipate heat.

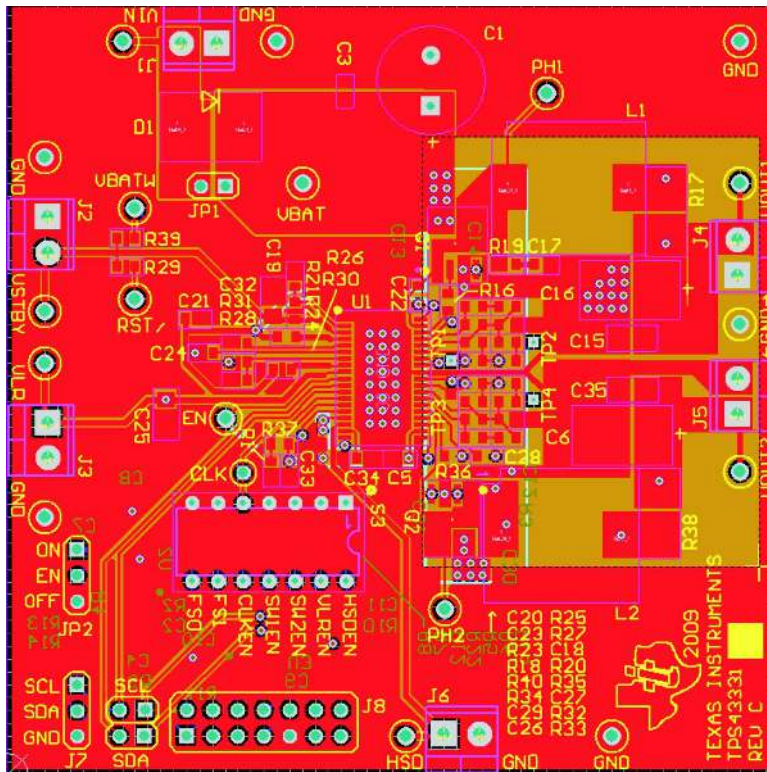

Figure 5. Top Assembly Layer

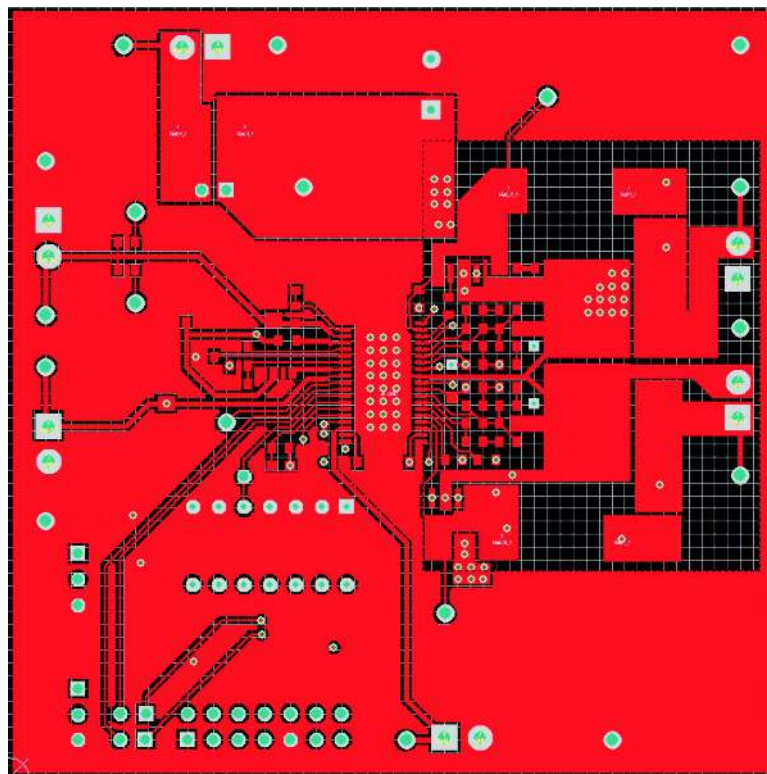

Figure 6. Top Layer Routing

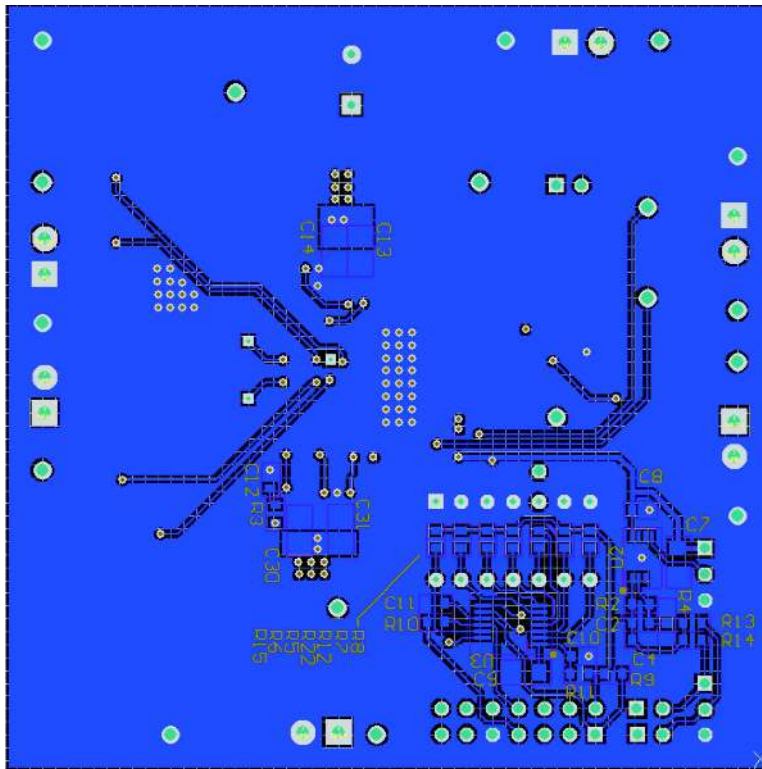

Figure 7. Bottom Assembly Layer

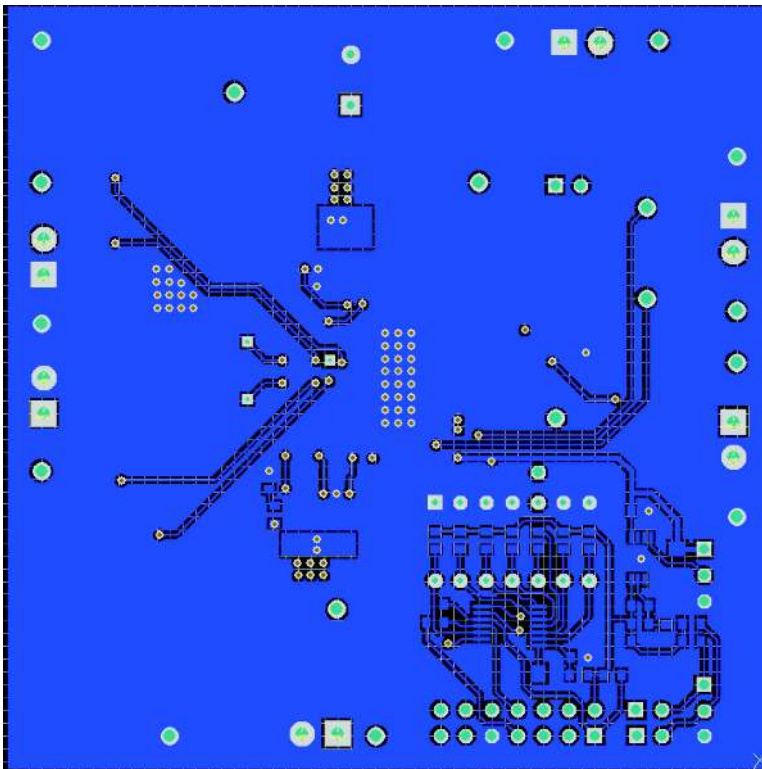

Figure 8. Bottom Layer Routing

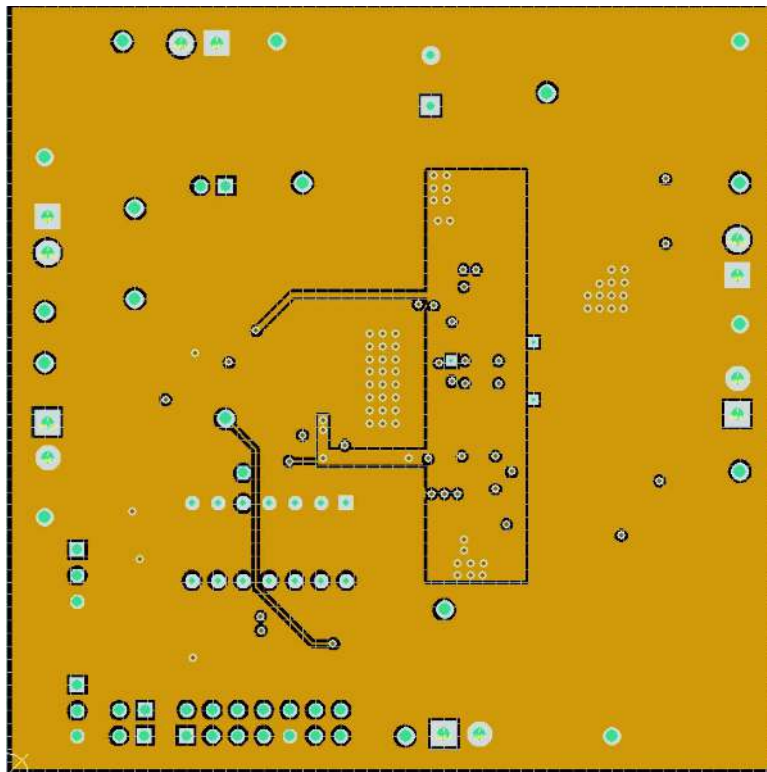

Figure 9. Internal Power Plane Layer

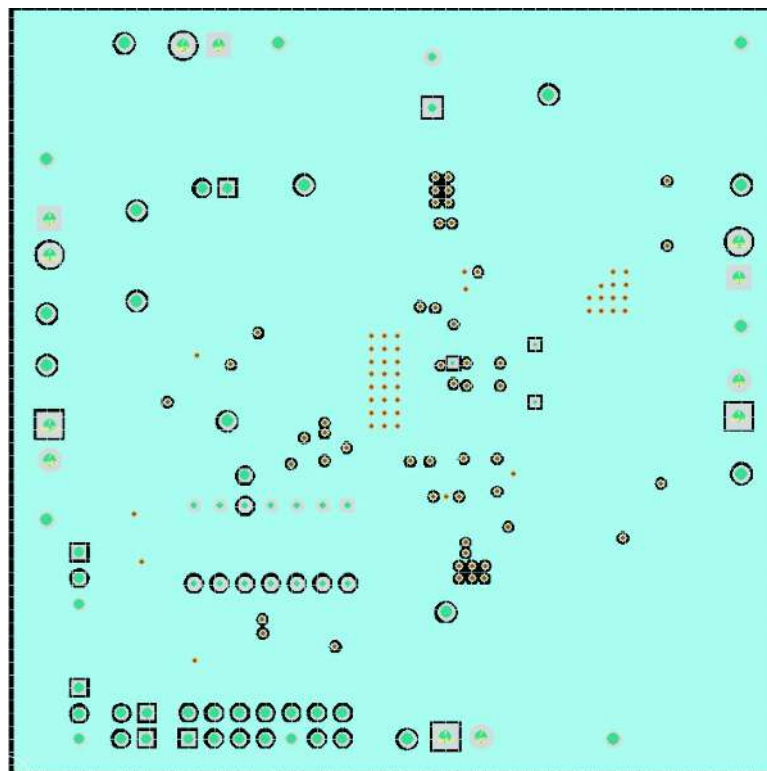

Figure 10. Internal Ground Plane Layer

4 Schematics and Bill of Materials

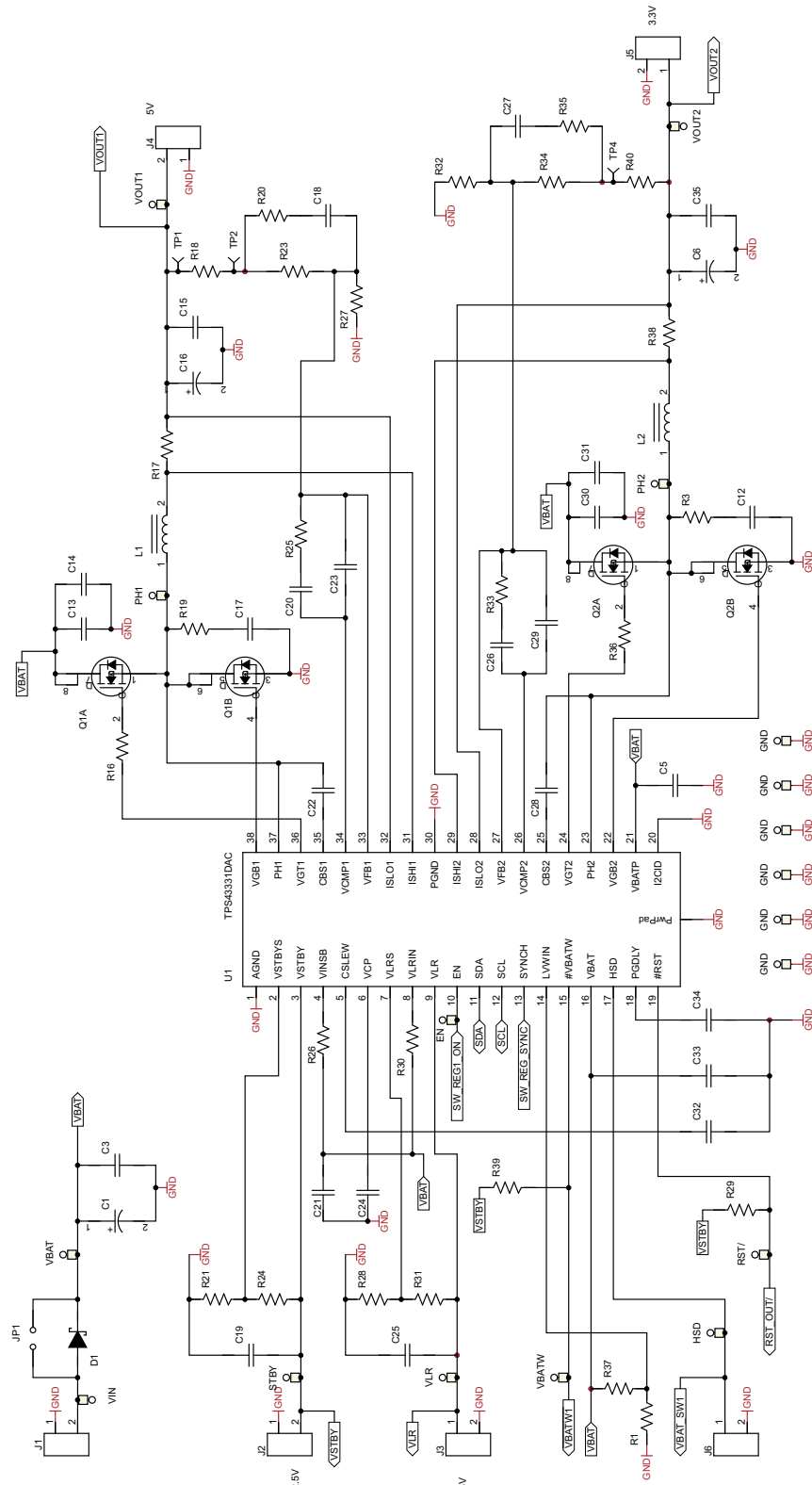

Figure 11. TPS43331EVM Schematic

Table 7. TPS4331EVM Bill of Materials

COUNT	REF DES	DESCRIPTION	SIZE	MFR	PART NUMBER
1	C1	Capacitor, electrolytic, 470mF, 50V, 20%	10mm x 20mm	Panasonic	ECA-1HHG471
2	C2, C11	Capacitor, ceramic, 100pF, 50V, 5%	603	muRata	GRM1885C1H101JA01D
9	C3, C5, C8, C10, C21, C22, C24, C28, C33	Capacitor, ceramic, 0.1mF, 50V, 10%	603	muRata	GRM188R71H104KA93D
1	C4	Capacitor, ceramic, 1mF, 16V, 10%	603	muRata	GRM185R61C105KE44B
2	C6, C16	Capacitor, ceramic, 100mF, 16V, 10%	7343-31	AVX	TPSD107M016R0060
1	C7	Capacitor, ceramic, 1mF, 50V, 10%	1206	muRata	GRM31CR71H105KA61L
3	C9, C19, C25	Capacitor, ceramic, 10mF, 16V, 10%	1206	muRata	GRM31CR61C106KC31L
4	C12, C17, C32, C34	Capacitor, ceramic, 1000pF, 50V, 10%	603	muRata	GRM188R71H102KA01D
4	C13, C14, C30, C31	Capacitor, ceramic, 4.7mF, 50V, 20%	1206	muRata	GRM31CF51H475ZA01L
2	C15, C35	Capacitor, ceramic, 2.2mF, 50V, 10%	1206	muRata	GRM31CR71H225KA88L
2	C18, C27	Capacitor, ceramic, 1200pF, 50V, 10%	603	muRata	GRM188R71H122KA01D
2	C20, C26	Capacitor, ceramic, 3300pF, 50V, 10%	603	muRata	GRM188R71H332KA01D
1	C23, C29	Capacitor, ceramic, 220pF, 50V, 10%	603	muRata	GRM188R71H221KA01D
1	D1	Diode, Schottky, 3A, 100V	SMC	IR	30BQ100
6	J1, J2, J3, J4, J5, J6	Terminal block, 2-pin, 6A, 3.5mm	0.25 x 0.27	OST	ED555/2DS
3	JP1, SCL, SDA	Header, 2-pin, 100-mil spacing, 36-pin strip	0.100 x 2	Sullins	PEC02SAAN
2	J7, JP2	Header, 3-pin, 100-mil spacing, 36-pin strip	0.100 x 3	Sullins	PEC03SAAN
1	J8	Dual row Header, 14-pin, 100-mil spacing, 72-pin strip	0.100 x 7	Sullins	PEC14DAAN
4	JP1, JP2, SCL, SDA,	Connector jumper, shorting, 100-mil spacing	0.1	Sullins	SPC02SYAN
2	L1, L2	Inductor, SMT, 22-uH, 5.44A, 52-mW	12.3mm x 12.3mm	Coilcraft	MSS1278T-223MLB
2	Q1, Q2	MOSFET, Dual N-Channel 60-V	SO8	Vishay	SI4946EY-T1-E3
1	R1	Resistor, chip, 1-M Ω , 1/10W, 1%	603	Panasonic	ERJ-3EKF1004V
1	R2	Resistor, chip, 158-k Ω , 1/10W, 1%	603	Panasonic	ERJ-3EKF1583V
4	R3, R16, R19, R36	Resistor, chip, 10- Ω , 1/10W, 1%	603	Panasonic	ERJ-3EKF10R0V
5	R4, R21, R28, R29, R39	Resistor, chip, 100-k Ω , 1/10W, 1%	603	Panasonic	ERJ-3EKF1003V
7	R5, R6, R7, R8, R15, R22, R27	Resistor, chip, 10-k Ω , 1/10W, 1%	603	Panasonic	ERJ-3EKF1002V
1	R9	Resistor, chip, 49.9-k Ω , 1/10W, 1%	603	Panasonic	ERJ-3EKF4992V
1	R10	Resistor, chip, 332- Ω , 1/10W, 1%	603	Panasonic	ERJ-3EKF3320V
3	R11, R26, R30	Resistor, chip, 0- Ω , 1/10W, 1%	603	Panasonic	ERJ-3GEY0R00V
1	R12	Resistor, chip, 100- Ω , 1/10W, 1%	603	Panasonic	ERJ-3EKF1000V
2	R13, R14	Resistor, chip, 2.2-k Ω , 1/10W, 1%	603	Panasonic	ERJ-3EKF2201V
2	R17, R38	Resistor, chip, 0.03- Ω , 1W, 1%	2512	Vishay	WSL2512R0300FEA
2	R18, R40	Resistor, chip, 49.9- Ω , 1/10W, 1%	603	Panasonic	ERJ-3EKF49R9V
2	R20, R35	Resistor, chip, 1.1-k Ω , 1/10W, 1%	603	Panasonic	ERJ-3EKF1101V
2	R23, R34	Resistor, chip, 40.2-k Ω , 1/10W, 1%	603	Panasonic	ERJ-3EKF4022V

Table 7. TPS43331EVM Bill of Materials (continued)

COUNT	REF DES	DESCRIPTION	SIZE	MFR	PART NUMBER
1	R24	Resistor, chip, 150-k Ω , 1/10W, 1%	603	Panasonic	ERJ-3EKF1503V
2	R25, R33	Resistor, chip, 29.4-k Ω , 1/10W, 1%	603	Panasonic	ERJ-3EKF2942V
1	R31	Resistor, chip, 698-k Ω , 1/10W, 1%	603	Panasonic	ERJ-3EKF6983V
1	R32	Resistor, chip, 17.4-k Ω , 1/10W, 1%	603	Panasonic	ERJ-3EKF1742V
1	R37	Resistor, chip, 4.7-M Ω , 1/10W, 5%	603	Panasonic	ERJ-3GEYJ475V
1	S3	DIP Switch, 7 position	2.54mm pitch	C&K	BD07
19	TP1, TP2, TP3, TP4, TP5, TP6, TP7, TP8, TP9, TP10, TP11, TP12, TP13, TP14, TP15, TP16, TP17, TP18, TP19	Test point, 52-mil	0.052	Kobiconn	151-103-RC
1	U2	IC, TPS79801DGN		TI	TPS79801QDGNRQ1
1	U3	IC, MSP430F2013PW		TI	MSP430F2013IPWR
1	U1	IC, TPS43331DAP		TI	TPS43331QDAPRQ1
1	-	PCB, 3-inch x 3-inch x 0.062		Any	TPS43331, REV C

EVALUATION BOARD/KIT IMPORTANT NOTICE

Texas Instruments (TI) provides the enclosed product(s) under the following conditions:

This evaluation board/kit is intended for use for **ENGINEERING DEVELOPMENT, DEMONSTRATION, OR EVALUATION PURPOSES ONLY** and is not considered by TI to be a finished end-product fit for general consumer use. Persons handling the product(s) must have electronics training and observe good engineering practice standards. As such, the goods being provided are not intended to be complete in terms of required design-, marketing-, and/or manufacturing-related protective considerations, including product safety and environmental measures typically found in end products that incorporate such semiconductor components or circuit boards. This evaluation board/kit does not fall within the scope of the European Union directives regarding electromagnetic compatibility, restricted substances (RoHS), recycling (WEEE), FCC, CE or UL, and therefore may not meet the technical requirements of these directives or other related directives.

Should this evaluation board/kit not meet the specifications indicated in the User's Guide, the board/kit may be returned within 30 days from the date of delivery for a full refund. **THE FOREGOING WARRANTY IS THE EXCLUSIVE WARRANTY MADE BY SELLER TO BUYER AND IS IN LIEU OF ALL OTHER WARRANTIES, EXPRESSED, IMPLIED, OR STATUTORY, INCLUDING ANY WARRANTY OF MERCHANTABILITY OR FITNESS FOR ANY PARTICULAR PURPOSE.**

The user assumes all responsibility and liability for proper and safe handling of the goods. Further, the user indemnifies TI from all claims arising from the handling or use of the goods. Due to the open construction of the product, it is the user's responsibility to take any and all appropriate precautions with regard to electrostatic discharge.

EXCEPT TO THE EXTENT OF THE INDEMNITY SET FORTH ABOVE, NEITHER PARTY SHALL BE LIABLE TO THE OTHER FOR ANY INDIRECT, SPECIAL, INCIDENTAL, OR CONSEQUENTIAL DAMAGES.

TI currently deals with a variety of customers for products, and therefore our arrangement with the user **is not exclusive**.

TI assumes **no liability for applications assistance, customer product design, software performance, or infringement of patents or services described herein**.

Please read the User's Guide and, specifically, the Warnings and Restrictions notice in the User's Guide prior to handling the product. This notice contains important safety information about temperatures and voltages. For additional information on TI's environmental and/or safety programs, please contact the TI application engineer or visit www.ti.com/esh.

No license is granted under any patent right or other intellectual property right of TI covering or relating to any machine, process, or combination in which such TI products or services might be or are used.

FCC Warning

This evaluation board/kit is intended for use for **ENGINEERING DEVELOPMENT, DEMONSTRATION, OR EVALUATION PURPOSES ONLY** and is not considered by TI to be a finished end-product fit for general consumer use. It generates, uses, and can radiate radio frequency energy and has not been tested for compliance with the limits of computing devices pursuant to part 15 of FCC rules, which are designed to provide reasonable protection against radio frequency interference. Operation of this equipment in other environments may cause interference with radio communications, in which case the user at his own expense will be required to take whatever measures may be required to correct this interference.

EVM WARNINGS AND RESTRICTIONS

It is important to operate this EVM within the input voltage range of -0.3 V to 30 V and the output voltage range of 1.2 V to 10 V.

Exceeding the specified input range may cause unexpected operation and/or irreversible damage to the EVM. If there are questions concerning the input range, please contact a TI field representative prior to connecting the input power.

Applying loads outside of the specified output range may result in unintended operation and/or possible permanent damage to the EVM. Please consult the EVM User's Guide prior to connecting any load to the EVM output. If there is uncertainty as to the load specification, please contact a TI field representative.

During normal operation, some circuit components may have case temperatures greater than 85°C. The EVM is designed to operate properly with certain components above 60°C as long as the input and output ranges are maintained. These components include but are not limited to linear regulators, switching transistors, pass transistors, and current sense resistors. These types of devices can be identified using the EVM schematic located in the EVM User's Guide. When placing measurement probes near these devices during operation, please be aware that these devices may be very warm to the touch.

IMPORTANT NOTICE

Texas Instruments Incorporated and its subsidiaries (TI) reserve the right to make corrections, modifications, enhancements, improvements, and other changes to its products and services at any time and to discontinue any product or service without notice. Customers should obtain the latest relevant information before placing orders and should verify that such information is current and complete. All products are sold subject to TI's terms and conditions of sale supplied at the time of order acknowledgment.

TI warrants performance of its hardware products to the specifications applicable at the time of sale in accordance with TI's standard warranty. Testing and other quality control techniques are used to the extent TI deems necessary to support this warranty. Except where mandated by government requirements, testing of all parameters of each product is not necessarily performed.

TI assumes no liability for applications assistance or customer product design. Customers are responsible for their products and applications using TI components. To minimize the risks associated with customer products and applications, customers should provide adequate design and operating safeguards.

TI does not warrant or represent that any license, either express or implied, is granted under any TI patent right, copyright, mask work right, or other TI intellectual property right relating to any combination, machine, or process in which TI products or services are used. Information published by TI regarding third-party products or services does not constitute a license from TI to use such products or services or a warranty or endorsement thereof. Use of such information may require a license from a third party under the patents or other intellectual property of the third party, or a license from TI under the patents or other intellectual property of TI.

Reproduction of TI information in TI data books or data sheets is permissible only if reproduction is without alteration and is accompanied by all associated warranties, conditions, limitations, and notices. Reproduction of this information with alteration is an unfair and deceptive business practice. TI is not responsible or liable for such altered documentation. Information of third parties may be subject to additional restrictions.

Resale of TI products or services with statements different from or beyond the parameters stated by TI for that product or service voids all express and any implied warranties for the associated TI product or service and is an unfair and deceptive business practice. TI is not responsible or liable for any such statements.

TI products are not authorized for use in safety-critical applications (such as life support) where a failure of the TI product would reasonably be expected to cause severe personal injury or death, unless officers of the parties have executed an agreement specifically governing such use. Buyers represent that they have all necessary expertise in the safety and regulatory ramifications of their applications, and acknowledge and agree that they are solely responsible for all legal, regulatory and safety-related requirements concerning their products and any use of TI products in such safety-critical applications, notwithstanding any applications-related information or support that may be provided by TI. Further, Buyers must fully indemnify TI and its representatives against any damages arising out of the use of TI products in such safety-critical applications.

TI products are neither designed nor intended for use in military/aerospace applications or environments unless the TI products are specifically designated by TI as military-grade or "enhanced plastic." Only products designated by TI as military-grade meet military specifications. Buyers acknowledge and agree that any such use of TI products which TI has not designated as military-grade is solely at the Buyer's risk, and that they are solely responsible for compliance with all legal and regulatory requirements in connection with such use.

TI products are neither designed nor intended for use in automotive applications or environments unless the specific TI products are designated by TI as compliant with ISO/TS 16949 requirements. Buyers acknowledge and agree that, if they use any non-designated products in automotive applications, TI will not be responsible for any failure to meet such requirements.

Following are URLs where you can obtain information on other Texas Instruments products and application solutions:

Products

Amplifiers	amplifier.ti.com
Data Converters	dataconverter.ti.com
DLP® Products	www.dlp.com
DSP	dsp.ti.com
Clocks and Timers	www.ti.com/clocks
Interface	interface.ti.com
Logic	logic.ti.com
Power Mgmt	power.ti.com
Microcontrollers	microcontroller.ti.com
RFID	www.ti-rfid.com
RF/IF and ZigBee® Solutions	www.ti.com/lprf

Applications

Audio	www.ti.com/audio
Automotive	www.ti.com/automotive
Broadband	www.ti.com/broadband
Digital Control	www.ti.com/digitalcontrol
Medical	www.ti.com/medical
Military	www.ti.com/military
Optical Networking	www.ti.com/opticalnetwork
Security	www.ti.com/security
Telephony	www.ti.com/telephony
Video & Imaging	www.ti.com/video
Wireless	www.ti.com/wireless

Mailing Address: Texas Instruments, Post Office Box 655303, Dallas, Texas 75265
Copyright © 2009, Texas Instruments Incorporated