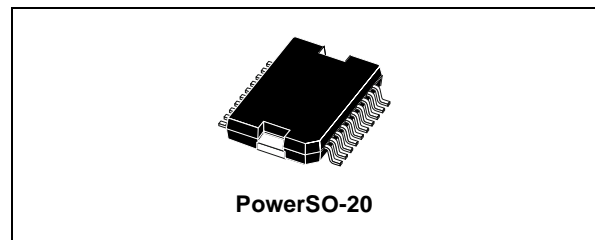




## LNBH21

# LNB SUPPLY AND CONTROL IC WITH STEP-UP CONVERTER AND I<sup>2</sup>C INTERFACE

- COMPLETE INTERFACE BETWEEN LNB AND I<sup>2</sup>C™ BUS
- BUILT-IN DC/DC CONTROLLER FOR SINGLE 12V SUPPLY OPERATION AND HIGH EFFICIENCY (Typ. 94% @ 750mA)
- TWO SELECTABLE OUTPUT CURRENT LIMIT (450mA / 750mA)
- BOTH COMPLIANT WITH EUTELSAT AND DIRECT OUTPUT VOLTAGE SPECIFICATION
- ACCURATE BUILT-IN 22KHz TONE OSCILLATOR SUITS WIDELY ACCEPTED STANDARDS
- FAST OSCILLATOR START-UP FACILITATES DiSEqC™ ENCODING
- BUILT-IN 22KHz TONE DETECTOR SUPPORTS BI-DIRECTIONAL DiSEqC™2.0
- SEMI-LOWDROP POST REGULATOR AND HIGH EFFICIENCY STEP-UP PWM FOR LOW POWER LOSS: Typ. 0.56W @ 125mA
- TWO OUTPUT PINS SUITABLE TO BYPASS THE OUTPUT R-L FILTER AND AVOID ANY TONE DISTORSION (R-L FILTER AS PER DiSEqC 2.0 SPECS, see application circuit on pag. 5)
- CABLE LENGTH DIGITAL COMPENSATION
- OVERLOAD AND OVER-TEMPERATURE INTERNAL PROTECTIONS

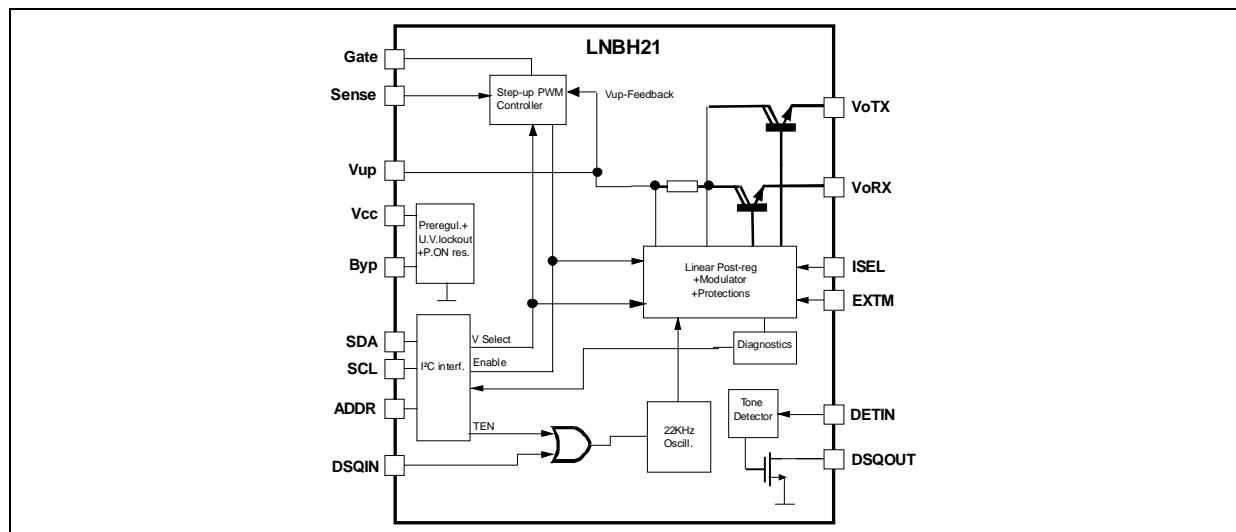


- OVERLOAD AND OVER-TEMPERATURE I<sup>2</sup>C DIAGNOSTIC BITS
- LNB SHORT CIRCUIT SOA PROTECTION WITH I<sup>2</sup>C DIAGNOSTIC BIT
- +/- 4KV ESD TOLERANT ON INPUT/ OUTPUT POWER PINS

### DESCRIPTION

Intended for analog and digital satellite STB receivers/SatTV, sets/PC cards, the LNBH21 is a monolithic voltage regulator and interface IC, assembled in POWER SO-20, specifically designed to provide the 13/18V power supply and the 22KHz tone signalling to the LNB downconverter in the antenna or to the multiswitch box. In this application field, it offers a complete solution with extremely low component count, low power dissipation together with simple design and I<sup>2</sup>C™ standard interfacing.

### BLOCK DIAGRAM



# LNBH21

## ORDERING CODES

TYPE	PowerSO-20 (Tube)	PowerSO-20 (Tape & Reel)
LNBH21	LNBH21PD	LNBH21PD-TR

## ABSOLUTE MAXIMUM RATINGS

Symbol	Parameter	Value	Unit
$V_{CC}$	DC Input Voltage	-0.3 to 16	V
$V_{UP}$	DC Input Voltage	-0.3 to 25	V
$I_O$	Output Current	Internally Limited	mA
$V_{O\text{TX/RX}}$	DC Output Pins Voltage	-0.3 to 25	V
$V_I$	Logic Input Voltage (SDA, SCL, DSQIN, ISEL)	-0.3 to 7	V
$V_{\text{DETIN}}$	Detector Input Signal Amplitude	-0.3 to 2	$V_{PP}$
$V_{OH}$	Logic High Output Voltage (DSQOUT)	-0.3 to 7	V
$I_{\text{GATE}}$	Gate Current	$\pm 400$	mA
$V_{\text{SENSE}}$	Current Sense Voltage	-0.3 to 1	V
$V_{\text{ADDRESS}}$	Address Pin Voltage	-0.3 to 7	V
$T_{\text{stg}}$	Storage Temperature Range	-40 to +150	$^{\circ}\text{C}$
$T_{\text{op}}$	Operating Junction Temperature Range	-40 to +125	$^{\circ}\text{C}$

Absolute Maximum Ratings are those values beyond which damage to the device may occur. Functional operation under these condition is not implied.

## THERMAL DATA

Symbol	Parameter	Value	Unit
$R_{\text{thj-case}}$	Thermal Resistance Junction-case	2	$^{\circ}\text{C/W}$

## PIN CONFIGURATION (top view)

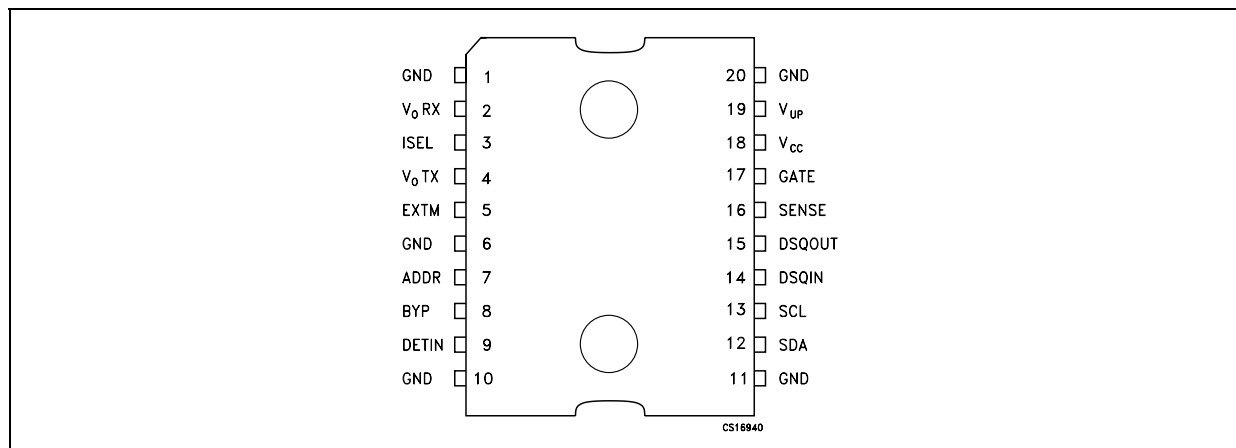


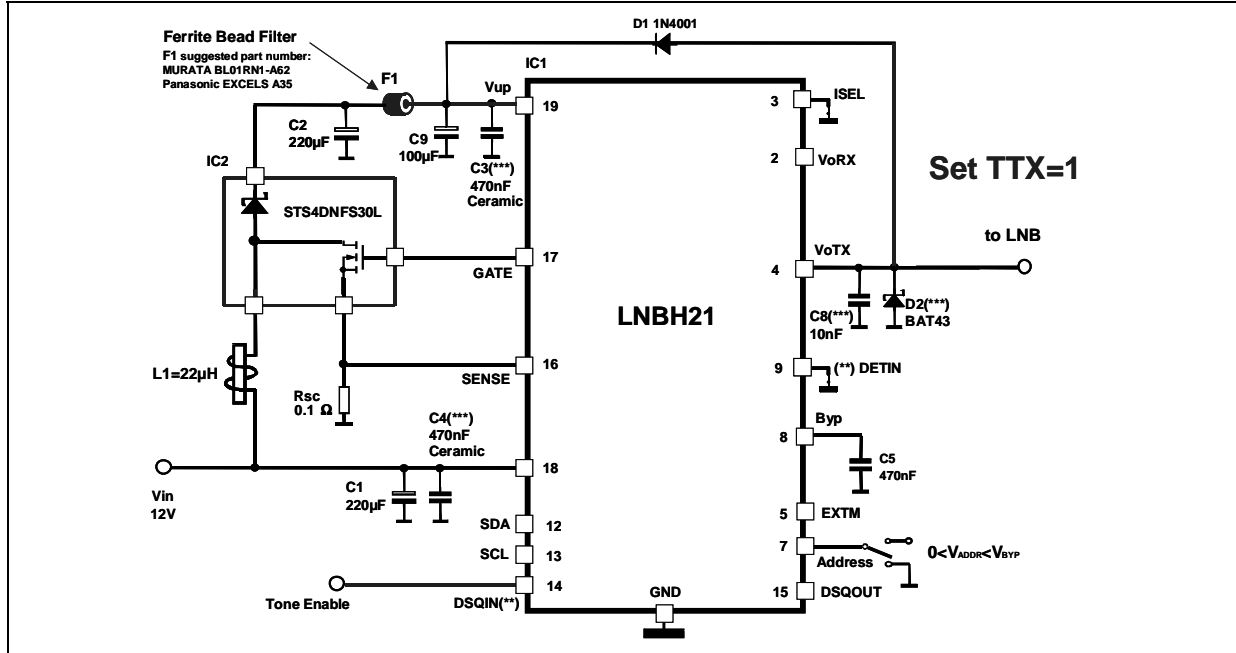
TABLE A: PIN CONFIGURATIONS

PIN N°	SYMBOL	NAME	FUNCTION
18	V <sub>CC</sub>	Supply Input	8V to 15V IC supply. A 220μF bypass capacitor to GND with a 470nF (ceramic) in parallel is recommended
17	GATE	External Switch Gate	External MOS switch Gate connection of the step-up converter
16	SENSE	Current Sense Input	DC/DC Current Sense comparator input. Connected to current sensing resistor
19	V <sub>UP</sub>	Step-up Voltage	Input of the linear post-regulator. The voltage on this pin is monitored by internal step-up controller to keep a minimum dropout across the linear pass transistor
2	V <sub>ORX</sub>	Output Port during 22KHz Tone RX	RX Output to the LNB in DiSEqC 2.0 application. See truth tables for voltage selections on page 8 and description on page 5.
12	SDA	Serial Data	Bidirectional data from/to I <sup>2</sup> C bus.
13	SCL	Serial Clock	Clock from I <sup>2</sup> C bus.
14	DSQIN	DiSEqC Input	When the TEN bit of the System Register is LOW, this pin will accept the DiSEqC code from the main μcontroller. The LNBH21 will use this code to modulate the internally generated 22kHz carrier. Set to GND this pin if not used.
9	DETIN	Tone Detector Input	22kHz Tone Detector Input. Must be AC coupled to the DiSEqC 2.0 bus.
15	DSQOUT	DiSEqC Output	Open drain output of the tone Detector to the main μcontroller for DiSEqC 2.0 data decoding. It is LOW when tone is detected.
5	EXTM	External Modulator	External Modulation Input acts on V <sub>OTX</sub> . Needs DC decoupling to the AC source. If not used, can be left open.
1, 6, 10, 11, 20	GND	Ground	Pins Connected to Ground.
8	BYP	Bypass Capacitor	Needed for internal preregulator filtering
3	ISEL	Current Limit Select	Set high or floating for I <sub>OUT</sub> ≤ 750mA, connect to ground for I <sub>OUT</sub> ≤ 450mA.
4	V <sub>OTX</sub>	Output Port during 22KHz Tone TX	Output of the linear post-regulator/modulator to the LNB. See truth tables for voltage selections.
7	ADDR	Address Setting	Four I <sup>2</sup> C bus addresses available by setting the Address Pin level voltage. See address pin characteristics table.

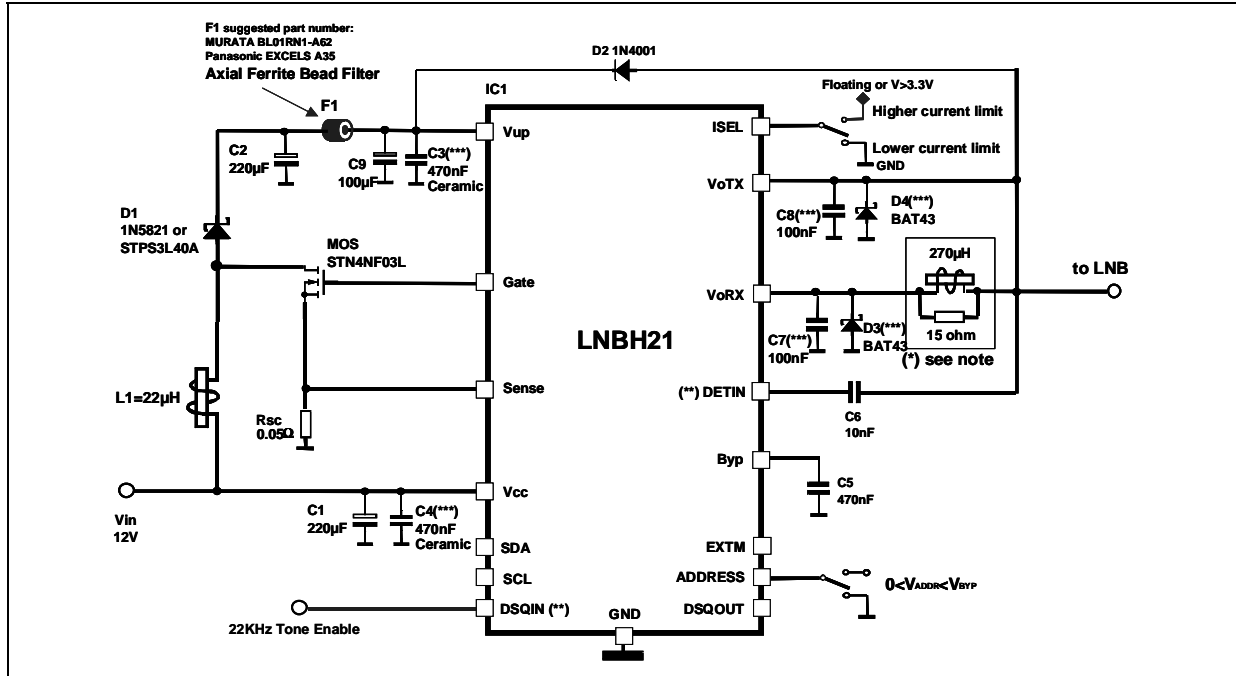
# LN BH21

## TYPICAL APPLICATION CIRCUITS

### Application Circuit for DiSEqC 1.x and Output Current < 450 mA



### Full Application Circuit for Bi-directional DiSEqC 2.0 and Output Current up to 750mA



(\*) Filter to be used according to EUTELSAT recommendation to implement the DiSEqC™ 2.0, (see DiSEqC™ implementation on page 8). If bidirectional DiSEqC™ 2.0 is not implemented it can be removed both with C8 and D4.

(\*\*) Do not leave these pins floating if not used.

(\*\*\*) To be soldered as close as possible to relative pins.

-C8 and D3,4 are needed only to protect the output pins from any negative voltage spikes during high speed voltage transitions.

## APPLICATION INFORMATION

This IC has a built in DC/DC step-up controller that, from a single supply source ranging from 8 to 15V, generates the voltages ( $V_{UP}$ ) that let the linear post-regulator to work at a minimum dissipated power of 1.65W typ. @ 750mA load (the linear regulator drop voltage is internally kept at:  $V_{UP}-V_O=2.2V$  typ.). An UnderVoltage Lockout circuit will disable the whole circuit when the supplied  $V_{CC}$  drops below a fixed threshold (6.7V typically). The internal 22KHz tone generator is factory trimmed in accordance to the standards, and can be controlled either by the I<sup>2</sup>C™ interface or by a dedicated pin (DSQIN) that allows immediate DiSeqC™ data encoding (\*). When the TEN (Tone ENable) I<sup>2</sup>C bit it is set to HIGH, a continuous 22KHz tone is generated on the output regardless of the DSQIN pin logic status.

The TEN bit must be set LOW when the DSQIN pin is used for DiSeqC™ encoding. The fully bi-directional DiSeqC™ 2.0 interfacing is completed by the built-in 22KHz tone detector. Its input pin (DETIN) must be AC coupled to the DiSeqC™ bus, and the extracted PWK data are available on the DSQOUT pin (\*).

To comply to the bi-directional DiSeqC™ 2.0 bus hardware requirements an output R-L filter is needed. The LNBH21 is provided with two output pins: the  $V_{OTX}$  to be used during the tone transmission and the  $V_{ORX}$  to be used when the tone is received. This allows the 22KHz Tone to pass without any losses due to the R-L filter impedance (see DiSeqC 2.0 application circuit on page 5). In DiSeqC 2.0 applications during the 22KHz transmission activated by DSQIN pin (or TEN I<sup>2</sup>C bit), the  $V_{OTX}$  pin must be preventively set ON by the TTX I<sup>2</sup>C bit and, both the 13/18V power supply and the 22KHz tone, are provided by mean of  $V_{OTX}$  output. As soon as the tone transmission is expired, the  $V_{OTX}$  must be set to OFF by setting the TTX I<sup>2</sup>C bit to zero and the 13/18V power supply is provided to the LNB by the  $V_{ORX}$  pin through the R-L filter. When the LNBH21 is used in DiSeqC 1.x applications the R-L filter is not required (see DiSeqC 1.x application circuit on pag.5), the TTX I<sup>2</sup>C bit must be kept always to HIGH so that, the  $V_{OTX}$  output pin can provide both the 13/18V power supply and the 22KHz tone, enabled by DSQIN pin or by TEN I<sup>2</sup>C bit.

All the functions of this IC are controlled via I<sup>2</sup>C™ bus by writing 6 bits on the System Register (SR, 8 bits). The same register can be read back, and two bits will report the diagnostic status. When the IC is put in Stand-by (EN bit LOW), the power blocks are disabled. When the regulator blocks are active (EN bit HIGH), the output can be logic controlled to be 13 or 18 V by mean of the  $V_{SEL}$  bit (Voltage SElect) for remote controlling of non-DiSeqC LNBS.

Additionally, the LNBH21 is provided with the LLC I<sup>2</sup>C bit that increase the selected voltage value (+1V when  $V_{SEL}=0$  and +1.5V when  $V_{SEL}=1$ ) to compensate for the excess voltage drop along the coaxial cable (LLC bit HIGH).

By mean of the LLC bit, the LNBH21 is also compliant to the American LNB power supply standards that require the higher output voltage level to 19.5V (typ.) (instead of 18V), by simply setting the LLC=1 when  $V_{SEL}=1$ .

In order to improve design flexibility and to allow implementation of newcoming LNB remote control standards, an analogic modulation input pin is available (EXTM). An appropriate DC blocking capacitor must be used to couple the modulating signal source to the EXTM pin. Also in this case, the  $V_{OTX}$  output must be set ON during the tone transmission by setting the TTX bit high. When external modulation is not used, the relevant pin can be left open.

The current limitation block is SOA type and it is possible to select two current limit thresholds, by the dedicated  $I_{SEL}$  pin. The higher threshold is in the range of 750mA to 1A if the  $I_{SEL}$  is left floating or connected a voltage > 3.3V. The lower threshold is in the range of 450mA to 700mA when the  $I_{SEL}$  pin is connected to ground. When the output port is shorted to ground, the SOA current limitation block limits the short circuit current ( $I_{SC}$ ) at typically 400mA or 200mA respectively for  $V_O$  13V or 18V, to reduce the power dissipation. Moreover, it is possible to set the Short Circuit Current protection either statically (simple current clamp) or dynamically by the PCL bit of the I<sup>2</sup>C SR; when the PCL (Pulsed Current Limiting) bit is set to LOW, the overcurrent protection circuit works dynamically, as soon as an overload is detected, the output is shut-down for a time  $T_{OFF}$ , typically 900ms. Simultaneously the OLF bit of the System Register is set to HIGH. After this time has elapsed, the output is resumed for a time  $T_{ON}=1/10T_{OFF}$  (typ.). At the end of  $T_{ON}$ , if the overload is still detected, the protection circuit will cycle again through  $T_{OFF}$  and  $T_{ON}$ . At the end of a full  $T_{ON}$  in which no overload is detected, normal operation is resumed and the OLF bit is reset to LOW. Typical  $T_{ON}+T_{OFF}$  time is 990ms and it is determined by an internal timer. This dynamic operation can greatly reduce the power dissipation in short circuit condition, still ensuring excellent power-on start up in most conditions.

However, there could be some cases in which an highly capacitive load on the output may cause a difficult start-up when the dynamic protection is chosen. This can be solved by initiating any power start-up in static mode (PCL=HIGH) and then switching to the dynamic mode (PCL=LOW) after a chosen amount of time. When in static mode, the OLF bit goes HIGH when the current clamp limit is reached and returns LOW when the overload condition is cleared.

This IC is also protected against overheating: when the junction temperature exceeds 150°C (typ.), the step-up converter and the linear regulator are shut off, and the OTF SR bit is set to HIGH. Normal operation is resumed and the OTF bit is reset to LOW when the junction is cooled down to 140°C (typ.).

(\*): External components are needed to comply to bi-directional DiSEqC™ bus hardware requirements. Full compliance of the whole application with DiSEqC™ specifications is not implied by the use of this IC

**I<sup>2</sup>C BUS INTERFACE**

Data transmission from main μP to the LNBH21 and viceversa takes place through the 2 wires I<sup>2</sup>C bus interface, consisting of the two lines SDA and SCL (pull-up resistors to positive supply voltage must be externally connected).

**DATA VALIDITY**

As shown in fig. 1, the data on the SDA line must be stable during the high period of the clock. The HIGH and LOW state of the data line can only change when the clock signal on the SCL line is LOW.

**START AND STOP CONDITIONS**

As shown in fig.2 a start condition is a HIGH to LOW transition of the SDA line while SCL is HIGH. The stop condition is a LOW to HIGH transition of the SDA line while SCL is HIGH. A STOP conditions must be sent before each START condition.

**BYTE FORMAT**

Every byte transferred to the SDA line must contain 8 bits. Each byte must be followed by an acknowledge bit. The MSB is transferred first.

**ACKNOWLEDGE**

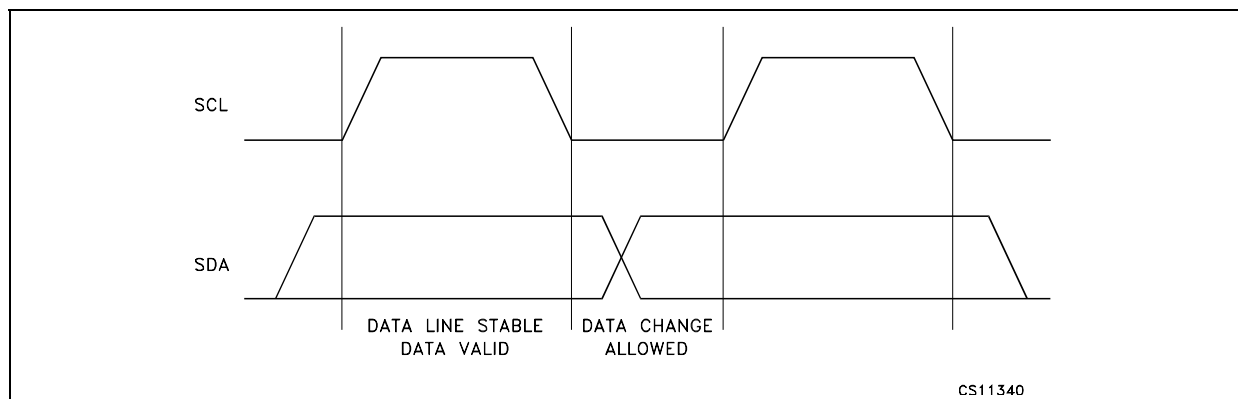
The master (μP) puts a resistive HIGH level on the SDA line during the acknowledge clock pulse (see fig. 3). The peripheral (LNBH21) that acknowledges has to pull-down (LOW) the SDA line during the acknowledge clock pulse, so that the SDA line is stable LOW during this clock pulse. The peripheral which has been addressed has to generate an acknowledge after the reception of each byte, otherwise the SDA line remains at the HIGH level during the ninth clock pulse time. In this case the master transmitter can generate the STOP information in order to abort the transfer. The LNBH21 won't generate the acknowledge if the V<sub>CC</sub> supply is below the Undervoltage Lockout threshold (6.7V typ.).

**TRANSMISSION WITHOUT ACKNOWLEDGE**

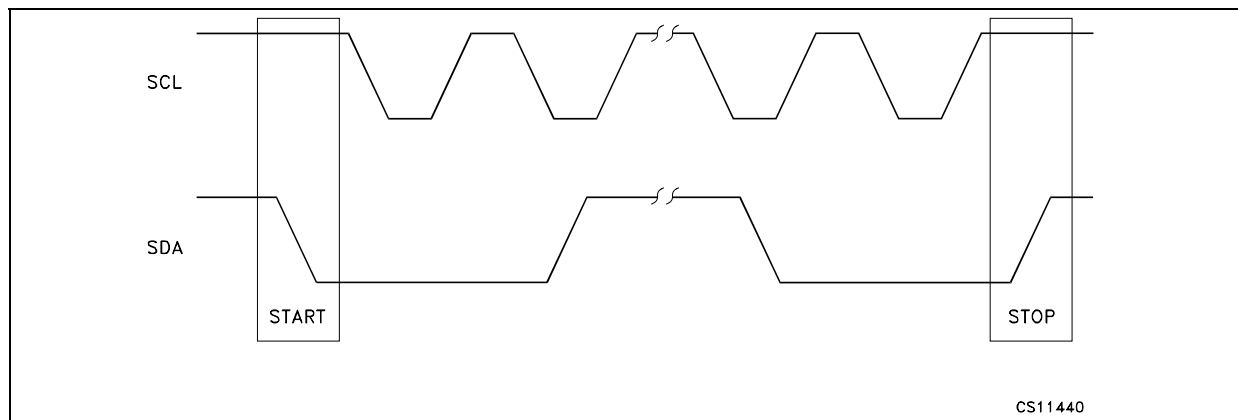
Avoiding to detect the acknowledge of the LNBH21, the μP can use a simpler transmission: simply it waits one clock without checking the slave acknowledging, and sends the new data.

This approach of course is less protected from misworking and decreases the noise immunity.

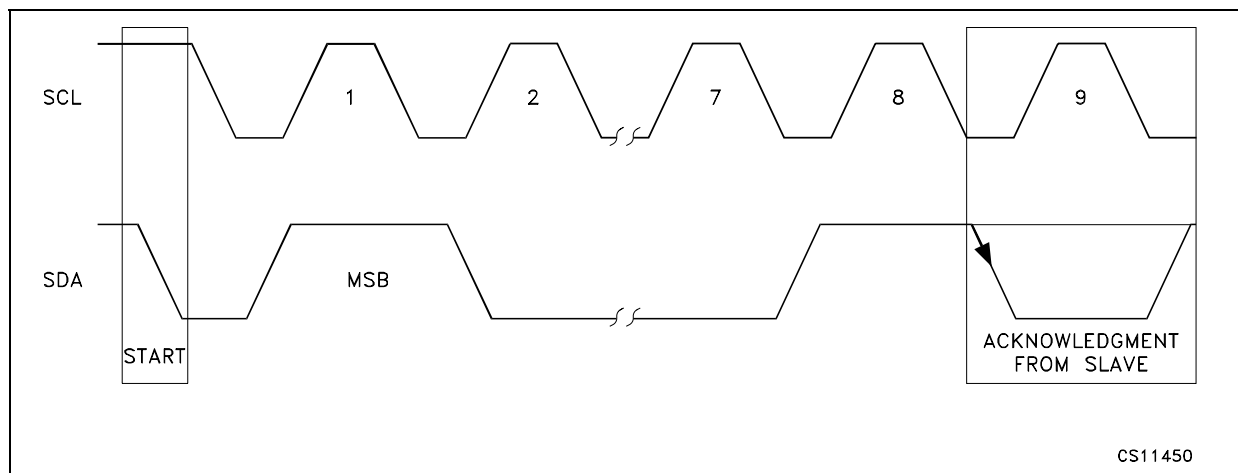
**Figure 1 : DATA VALIDITY ON THE I<sup>2</sup>C BUS**



**Figure 2 : TIMING DIAGRAM ON I<sup>2</sup>C BUS**



**Figure 3 : ACKNOWLEDGE ON I<sup>2</sup>C BUS**

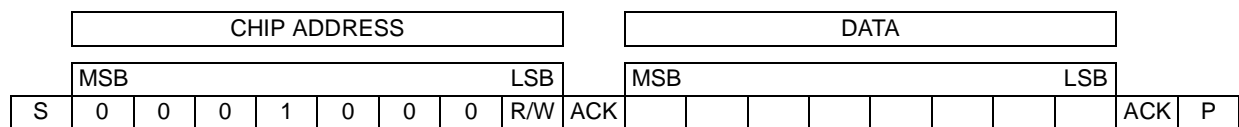


**LNBH21 SOFTWARE DESCRIPTION**

**INTERFACE PROTOCOL**

The interface protocol comprises:

- A start condition (S)
- A chip address byte = hex 10 / 11 (the LSB bit determines read(=1)/write(=0) transmission)
- A sequence of data (1 byte + acknowledge)
- A stop condition (P)



ACK= Acknowledge; S = Start ; P = Stop; R/W = Read/Write

**SYSTEM REGISTER (SR, 1 BYTE)**

MSB							LSB
R, W	R, W	R, W	R, W	R, W	R, W	R	R
PCL	TTX	TEN	LLC	VSEL	EN	OTF	OLF

R,W = read and write bit; R = Read-only bit  
All bits reset to 0 at Power-On



## LNBH21

### TRANSMITTED DATA (I<sup>2</sup>C BUS WRITE MODE)

When the R/W bit in the chip address is set to 0, the main  $\mu$ P can write on the System Register (SR) of the LNBH21 via I<sup>2</sup>C bus. Only 6 bits out of the 8 available can be written by the  $\mu$ P, since the remaining 2 are left to the diagnostic flags, and are read-only.

PCL	TTX	TEN	LLC	VSEL	EN	OTF	OLF	Function
			0	0	1	X	X	$V_O = 13.25$ V, $V_{UP} = 15.25$ V
			0	1	1	X	X	$V_O = 18$ V, $V_{UP} = 20$ V
			1	0	1	X	X	$V_O = 14.25$ V, $V_{UP} = 16.25$ V
			1	1	1	X	X	$V_O = 19.5$ V, $V_{UP} = 21.5$ V
		0			1	X	X	22KHz is controlled by DSQIN pin
		1			1	X	X	22KHz tone is ON, DSQIN pin disabled
	0				1	X	X	$V_{ORX}$ output is ON, output voltage controlled by VSEL and LLC
	1	X			1	X	X	$V_{OTX}$ output is ON, 22KHz controlled by DSQIN or TEN, output voltage level controlled by VSEL and LLC
0					1	X	X	Pulsed (dynamic) current limiting is selected
1					1	X	X	Static current limiting is selected
X	X	X	X	X	0	X	X	Power blocks disabled

X= don't care.

Values are typical unless otherwise specified

### RECEIVED DATA (I<sup>2</sup>C bus READ MODE)

The LNBH21 can provide to the Master a copy of the SYSTEM REGISTER information via I2C bus in read mode. The read mode is Master activated by sending the chip address with R/W bit set to 1. At the following master generated clocks bits, the LNBH21 issues a byte on the SDA data bus line (MSB transmitted first).

At the ninth clock bit the MCU master can:

- acknowledge the reception, starting in this way the transmission of another byte from the LNBH21;
- no acknowledge, stopping the read mode communication.

While the whole register is read back by the  $\mu$ P, only the two read-only bits OLF and OTF convey diagnostic informations about the LNBH21.

Values are typical unless otherwise specified.

PCL	TTX	TEN	LLC	VSEL	EN	OTF	OLF	Function
These bits are read exactly the same as they were left after last write operation						0		$T_J < 140^\circ\text{C}$ , normal operation
						1		$T_J > 150^\circ\text{C}$ , power block disabled
							0	$I_{OUT} < I_{OMAX}$ , normal operation
							1	$I_{OUT} > I_{OMAX}$ , overload protection triggered

Values are typical unless otherwise specified

### POWER-ON I<sup>2</sup>C INTERFACE RESET

The I<sup>2</sup>C interface built in the LNBH21 is automatically reset at power-on. As long as the  $V_{CC}$  stays below the UnderVoltage Lockout threshold (6.7V typ.), the interface will not respond to any I<sup>2</sup>C command and the System Register (SR) is initialized to all zeroes, thus keeping the power blocks disabled. Once the  $V_{CC}$  rises above 7.3V typ, the I<sup>2</sup>C interface becomes operative and the SR can be configured by the main  $\mu$ P. This is due to 500mV of hysteresis provided in the UVL threshold to avoid false retriggering of the Power-On reset circuit.

### ADDRESS PIN

Connecting this pin to GND the Chip I<sup>2</sup>C interface address is 0001000, but, it is possible to choice among 4 different addresses simply setting this pin at 4 fixed voltage levels (see table on page 10).



## DiSEqCTM IMPLEMENTATION

The LNBH21 helps the system designer to implement the bi-directional (2.0) DiSEqC protocol by allowing an easy PWK modulation/demodulation of the 22KHz carrier. The PWK data are exchanged between the LNBH21 and the main  $\mu$ P using logic levels that are compatible with both 3.3 and 5V microcontrollers. This data exchange is made through two dedicated pins, DSQIN and DSQOUT, in order to maintain the timing relationships between the PWK data and the PWK modulation as accurate as possible. These two pins should be directly connected to two I/O pins of the  $\mu$ P, thus leaving to the resident firmware the task of encoding and decoding the PWK data in accordance to the DiSEqC protocol. Full compliance of the system to the specification is thus not implied by the bare use of the LNBH21. The system designer should also take in consideration the bus hardware requirements; that can be simply accomplished by the R-L termination connected on the  $V_O$  pins of the LNBH21, as shown in the Typical Application Circuit on page 4. To avoid any losses due to the R-L impedance during the tone transmission, the LNBH21 has dedicated output ( $V_{O}TX$ ) that, in a DiSEqC 2.0 application, is connected after the filter and must be enabled by setting the TTX SR bit HIGH only during the tone transmission (see DiSEqC 2.0 operation description on page 2).

Unidirectional (1.x) DiSEqC and non-DiSEqC systems normally don't need this termination, and the  $V_{O}TX$  pin can be directly connected to the LNB supply port of the Tuner (see DiSEqC 1.x application circuit on pag.4). There is also no need of Tone Decoding, thus DETIN and DSQOUT pins can be left unconnected and the Tone is provided by the  $V_{O}TX$ .

**ELECTRICAL CHARACTERISTICS FOR LNBP SERIES** ( $T_J = 0$  to  $85^\circ\text{C}$ ,  $\text{EN}=1$ ,  $\text{TTX}=0/1$ ,  $\text{DSQIN}=\text{LOW}$ ,  $\text{LLC}=\text{TEN}=\text{PCL}=\text{VSEL}=0$ ,  $V_{\text{IN}}=12\text{V}$ ,  $I_{\text{O}}=50\text{mA}$ , unless otherwise specified. See software description section for I<sup>2</sup>C access to the system register).

Symbol	Parameter	Test Conditions	Min.	Typ.	Max.	Unit	
$V_{\text{IN}}$	Supply Voltage	$I_{\text{O}} = 750 \text{ mA}$ $\text{TEN}=\text{VSEL}=\text{LLC}=1$	8		15	V	
$I_{\text{I}}$	Supply Current	$\text{EN}=\text{TEN}=\text{VSEL}=\text{LLC}=1$ , NO LOAD		20	40	mA	
		$\text{EN}=0$		3.5	7		
$V_{\text{O}}$	Output Voltage	$I_{\text{O}} = 750 \text{ mA}$ $\text{VSEL}=1$	$\text{LLC}=0$	17.3	18	18.7	V
			$\text{LLC}=1$	18.7	19.5	20.3	
$V_{\text{O}}$	Output Voltage	$I_{\text{O}} = 750 \text{ mA}$ $\text{VSEL}=0$	$\text{LLC}=0$	12.75	13.25	13.75	V
			$\text{LLC}=1$	13.75	14.25	14.75	
$\Delta V_{\text{O}}$	Line Regulation	$V_{\text{IN}1} = 8$ to $15\text{V}$	$\text{VSEL}=0$		5	40	mV
			$\text{VSEL}=1$		5	60	
$\Delta V_{\text{O}}$	Load Regulation	$\text{VSEL}=0$ or $1$ , $I_{\text{O}} = 50$ to $750\text{mA}$			200	mV	
$I_{\text{MAX}}$	Output Current Limiting	$\text{ISEL} = \text{Floating}$ or $V > 3.3\text{V}$	750		1000	mA	
		$\text{ISEL} = \text{GND}$	450		700		
$I_{\text{SC}}$	Output Short Circuit Current		$\text{VSEL}=0$		300	mA	
			$\text{VSEL}=1$		200		
$t_{\text{OFF}}$	Dynamic Overload protection OFF Time	$\text{PCL}=0$ Output Shorted		900		ms	
$t_{\text{ON}}$	Dynamic Overload protection ON Time	$\text{PCL}=0$ Output Shorted		$t_{\text{OFF}}/10$		ms	
$f_{\text{TONE}}$	Tone Frequency	$\text{TEN}=1$	20	22	24	KHz	
$A_{\text{TONE}}$	Tone Amplitude	$\text{TEN}=1$	0.55	0.72	0.9	$V_{\text{PP}}$	
$D_{\text{TONE}}$	Tone Duty Cycle	$\text{TEN}=1$	40	50	60	%	
$t_r, t_f$	Tone Rise and Fall Time	$\text{TEN}=1$	5	8	15	$\mu\text{s}$	
$G_{\text{EXTM}}$	External Modulation Gain	$\Delta V_{\text{OUT}}/\Delta V_{\text{EXTM}}$ , $f = 10\text{Hz}$ to $50\text{KHz}$		6			
$V_{\text{EXTM}}$	External Input Voltage	AC Coupling			400	$\text{mV}_{\text{PP}}$	
$Z_{\text{EXTM}}$	External Modulation Impedance	$f = 10\text{Hz}$ to $50\text{KHz}$		260		$\Omega$	
$f_{\text{SW}}$	DC/DC Converter Switching Frequency			220		KHz	
$f_{\text{DETIN}}$	Tone Detector Frequency Capture Range	0.4Vpp sinewave	18		24	KHz	
$V_{\text{DETIN}}$	Tone Detector Input Amplitude	$f_{\text{IN}}=22\text{kHz}$ sinewave	0.2		1.5	$V_{\text{PP}}$	
$Z_{\text{DETIN}}$	Tone Detector Input Impedance			150		$\text{k}\Omega$	
$V_{\text{OL}}$	DSQOUT Pin Logic LOW	Tone present $I_{\text{OL}}=2\text{mA}$		0.3	0.5	V	
$I_{\text{OZ}}$	DSQOUT Pin Leakage Current	Tone absent $V_{\text{OH}} = 6\text{V}$			10	$\mu\text{A}$	
$V_{\text{IL}}$	DSQIN Input Pin Logic LOW				0.8	V	
$V_{\text{IH}}$	DSQIN Input Pin Logic HIGH		2			V	
$I_{\text{IH}}$	DSQIN Pins Input Current	$V_{\text{IH}} = 5\text{V}$		15		$\mu\text{A}$	
$I_{\text{OBK}}$	Output Backward Current	$\text{EN}=0$ , $V_{\text{OBK}} = 18\text{V}$		-6	-15	mA	
$T_{\text{SHDN}}$	Temperature Shutdown Threshold			150		$^\circ\text{C}$	
$\Delta T_{\text{SHDN}}$	Temperature Shutdown Hysteresis			15		$^\circ\text{C}$	

**GATE AND SENSE ELECTRICAL CHARACTERISTICS** ( $T_J = 0$  to  $85^\circ\text{C}$ ,  $V_{IN} = 12\text{V}$ )

Symbol	Parameter	Test Conditions	Min.	Typ.	Max.	Unit
$R_{\text{DSON-L}}$	Gate LOW $R_{\text{DSON}}$	$I_{\text{GATE}} = -100\text{mA}$		4.5		$\Omega$
$R_{\text{DSON-H}}$	Gate HIGH $R_{\text{DSON}}$	$I_{\text{GATE}} = 100\text{mA}$		4.5		$\Omega$
$V_{\text{SENSE}}$	Current Limit Sense Voltage			200		mV

**I<sup>2</sup>C ELECTRICAL CHARACTERISTICS** ( $T_J = 0$  to  $85^\circ\text{C}$ ,  $V_I = 12\text{V}$ )

Symbol	Parameter	Test Conditions	Min.	Typ.	Max.	Unit
$V_{\text{IL}}$	LOW Level Input Voltage	SDA, SCL			0.8	V
$V_{\text{IH}}$	HIGH Level Input Voltage	SDA, SCL	2			V
$I_I$	Input Current	SDA, SCL, $V_I = 0.4$ to $4.5\text{V}$	-10		10	$\mu\text{A}$
$V_{\text{OL}}$	Low Level Output Voltage	SDA (open drain), $I_{\text{OL}} = 6\text{mA}$			0.6	V
$f_{\text{MAX}}$	Maximum Clock Frequency	SCL	500			KHz

**ADDRESS PIN CHARACTERISTICS** ( $T_J = 0$  to  $85^\circ\text{C}$ ,  $V_{IN} = 12\text{V}$ )

Symbol	Parameter	Test Conditions	Min.	Typ.	Max.	Unit
$V_{\text{ADDR-1}}$	"0001000" Addr Pin Voltage		0		0.7	V
$V_{\text{ADDR-2}}$	"0001001" Addr Pin Voltage		1.3		1.7	V
$V_{\text{ADDR-3}}$	"0001010" Addr Pin Voltage		2.3		2.7	V
$V_{\text{ADDR-4}}$	"0001011" Addr Pin Voltage		3.3		5	V

### THERMAL DESIGN NOTES

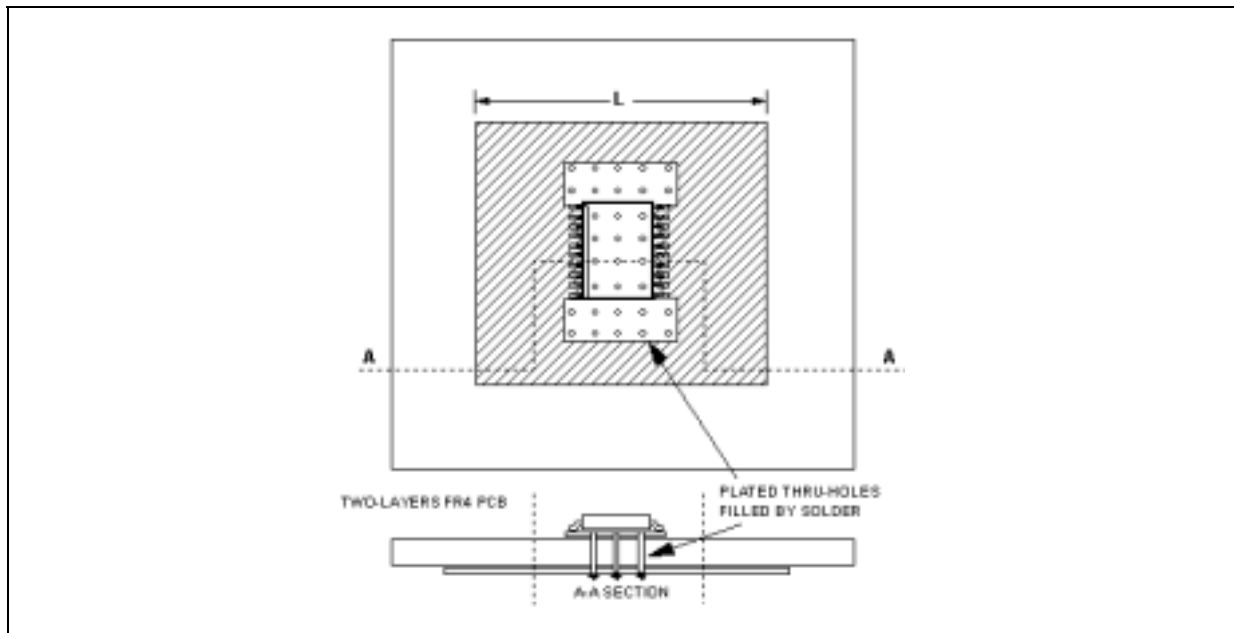
During normal operation, the LNBH21 device dissipates some power. At maximum rated output current (750mA), the voltage drop on the linear regulator lead to a total dissipated power that is typically 1.65W. The heat generated requires a suitable heatsink to keep the junction temperature below the over temperature protection threshold. Assuming a 45°C temperature inside the Set-Top-Box case, the total  $R_{thj-amb}$  has to be less than 48°C/W.

While this can be easily achieved using a through-hole power package that can be attached to a small heatsink or to the metallic frame of the receiver, a surface mount power package must rely on PCB solutions whose thermal efficiency is often limited. The simplest solution is to use a large, continuous copper area of the GND layer to dissipate the heat coming from the IC body.

Given an  $R_{thj-case}$  equal to 2°C/W, a maximum of 46°C/W are left to the PCB heatsink. This figure is achieved if a minimum of 6.5cm<sup>2</sup> copper area is placed just below the IC body. This area can be the inner GND layer of a multi-layer PCB, or, in a dual layer PCB, an unbroken GND area even on the opposite side where the IC is placed. In figure 4, it is shown a suggested layout for the PSO-20 package with a dual layer PCB, where the IC exposed pad connected to GND and the square dissipating area are thermally connected through 32 vias holes, filled by solder. This arrangement, when L=25mm, achieves an  $R_{thc-amb}$  of about 32°C/W.

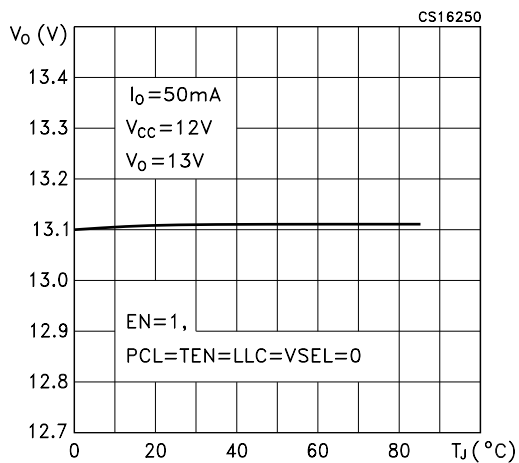
Different layouts are possible, too. Basic principles, however, suggest to keep the IC and its ground exposed pad approximately in the middle of the dissipating area; to provide as many vias as possible; to design a dissipating area having a shape as square as possible and not interrupted by other copper traces.

**Figure 4** : PowerSO-20 SUGGESTED PCB HEATSINK LAYOUT

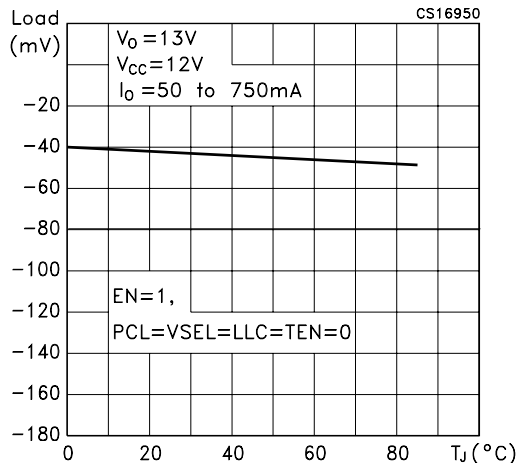


**TYPICAL CHARACTERISTICS** (unless otherwise specified  $T_j = 25^\circ\text{C}$ )

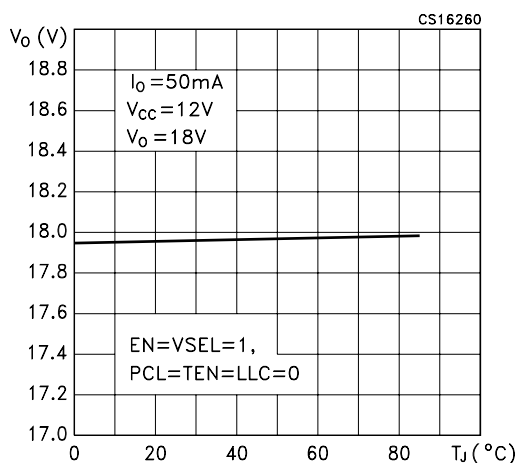
**Figure 5 :** Output Voltage vs Temperature



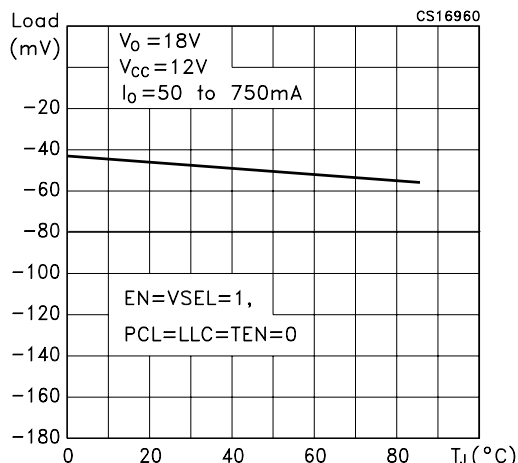
**Figure 8 :** Load Regulation vs Temperature



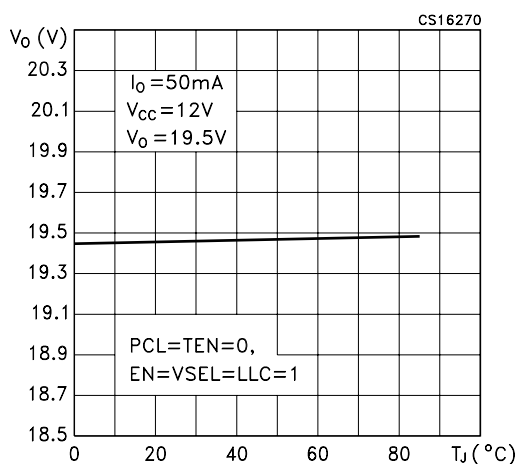
**Figure 6 :** Output Voltage vs Temperature



**Figure 9 :** Load Regulation vs Temperature



**Figure 7 :** Output Voltage vs Temperature



**Figure 10 :** Supply Current vs Temperature

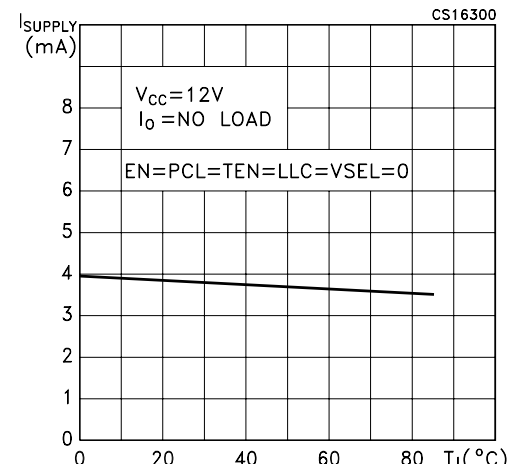


Figure 11 : Supply Current vs Temperature

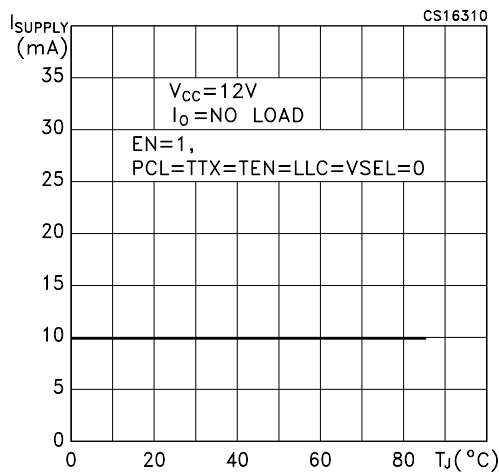


Figure 14 : Dynamic Overload Protection OFF Time vs Temperature

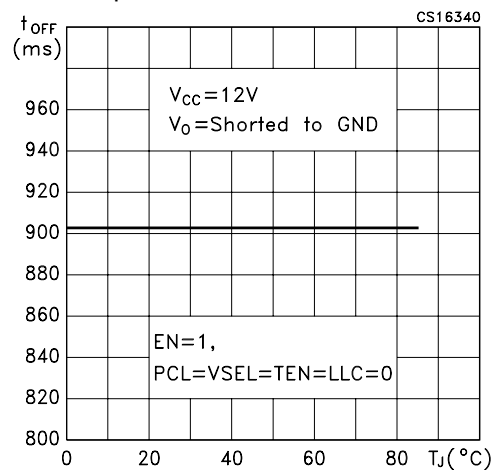


Figure 12 : Supply Current vs Temperature

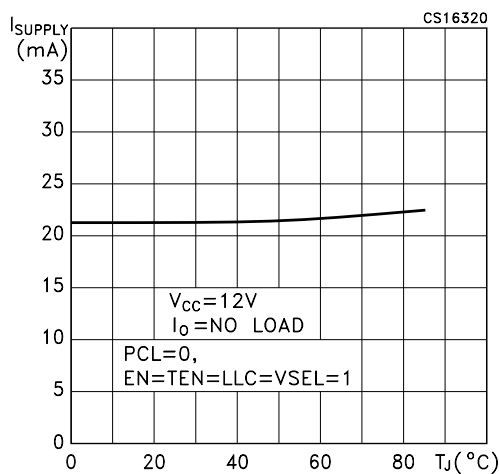


Figure 15 : Output Current Limiting vs Temperature

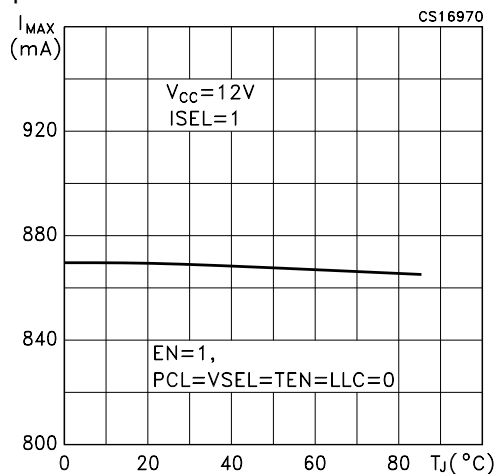


Figure 13 : Dynamic Overload Protection ON Time vs Temperature

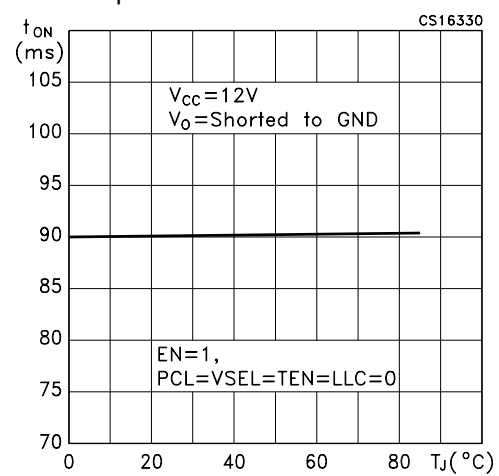


Figure 16 : Output Current Limiting vs Temperature

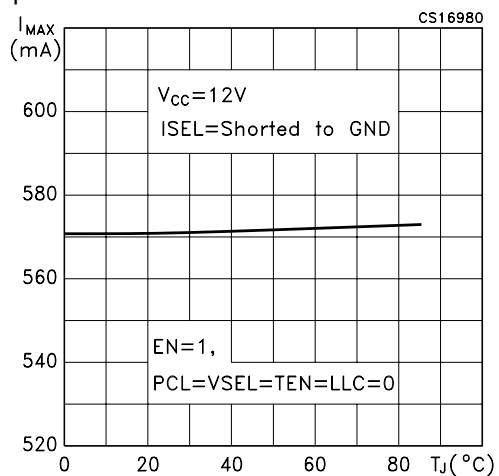


Figure 17 : Tone Frequency vs Temperature

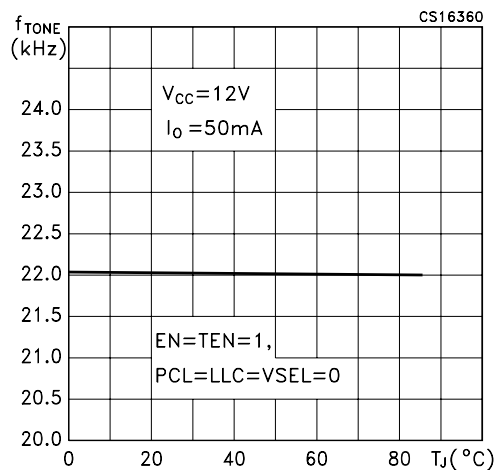


Figure 20 : Tone Rise Time vs Temperature

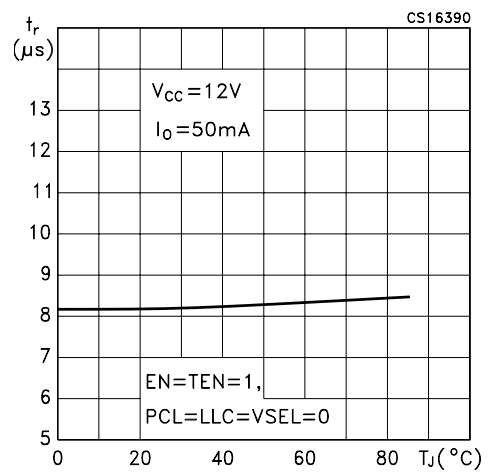


Figure 18 : Tone Amplitude vs Temperature

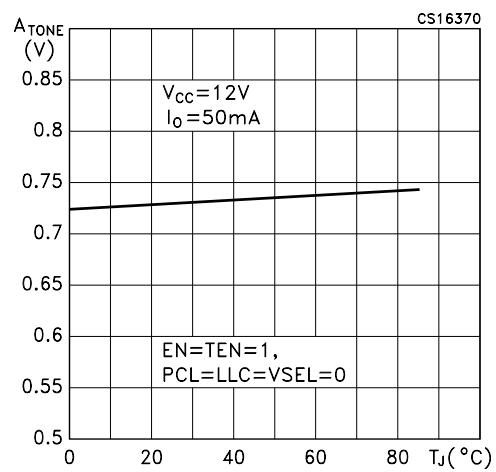


Figure 21 : Tone Fall Time vs Temperature

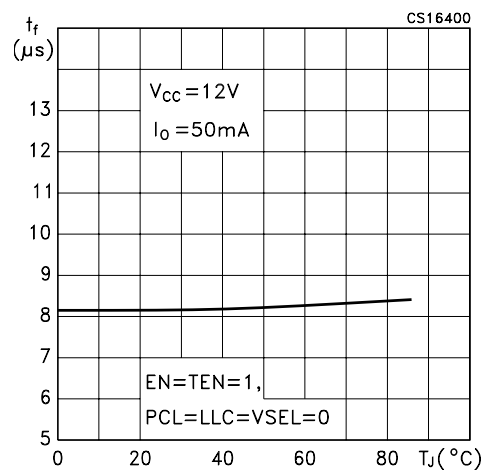


Figure 19 : Tone Duty Cycle vs Temperature

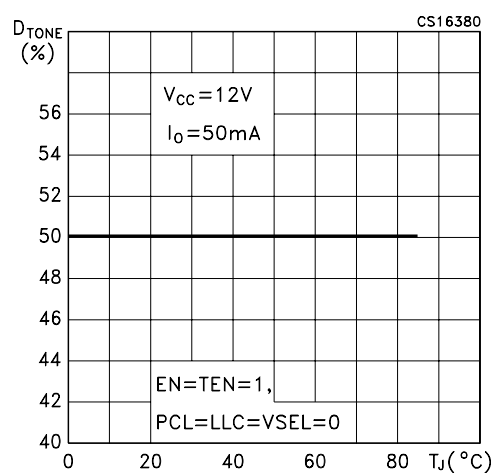
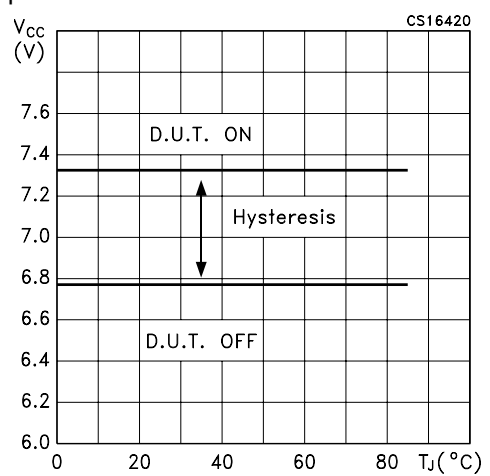
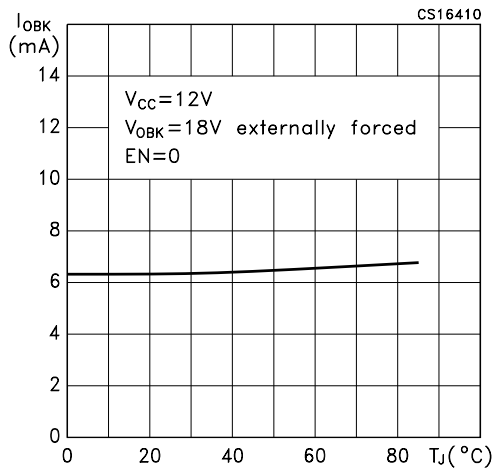


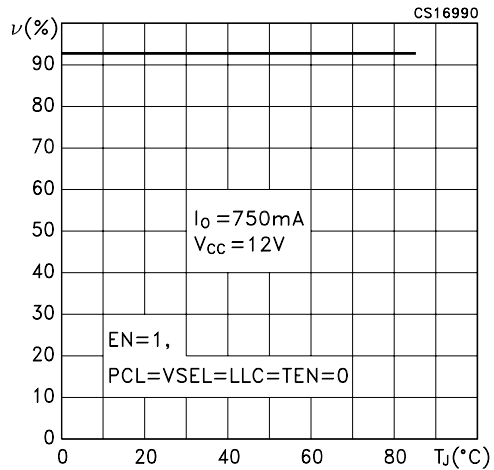
Figure 22 : Undervoltage Lockout Threshold vs Temperature



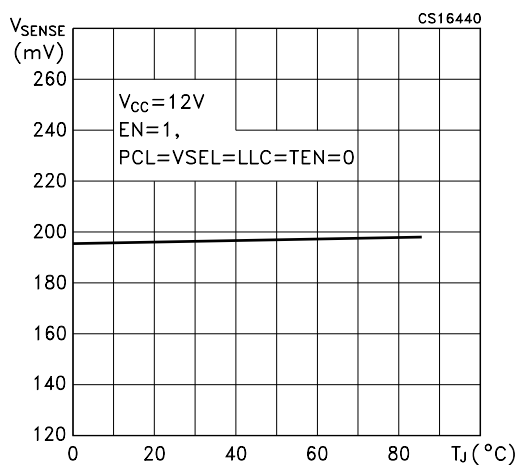
**Figure 23 : Output Backward Current vs Temperature**



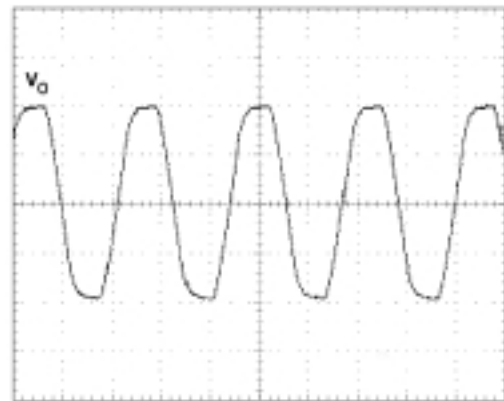
**Figure 24 : DC/DC Converter Efficiency vs Temperature**



**Figure 25 : Current Limit Sense Voltage vs Temperature**

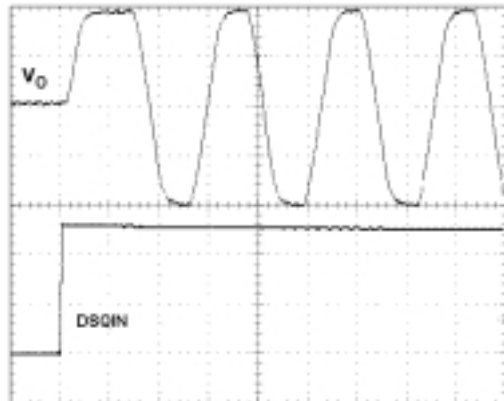


**Figure 26 : 22kHz Tone Waveform**



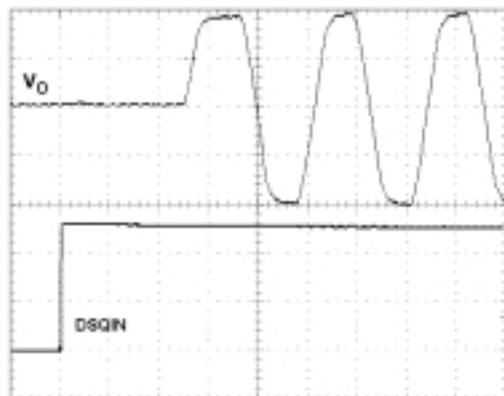
$V_{CC}=12V, I_O=50mA, EN=TEN=1$

**Figure 27 : DSQIN Tone Enable Transient Response**



$V_{CC}=12V, I_O=50mA, EN=1, \text{Tone enabled by DSQIN Pin}$

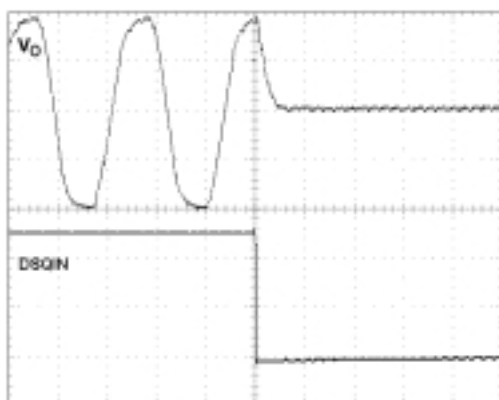
**Figure 28 : DSQIN Tone Enable Transient Response**



$V_{CC}=12V, I_O=50mA, EN=1, \text{Tone enabled by DSQIN Pin}$



**Figure 29** : DSQIN Tone Disable Transient Response

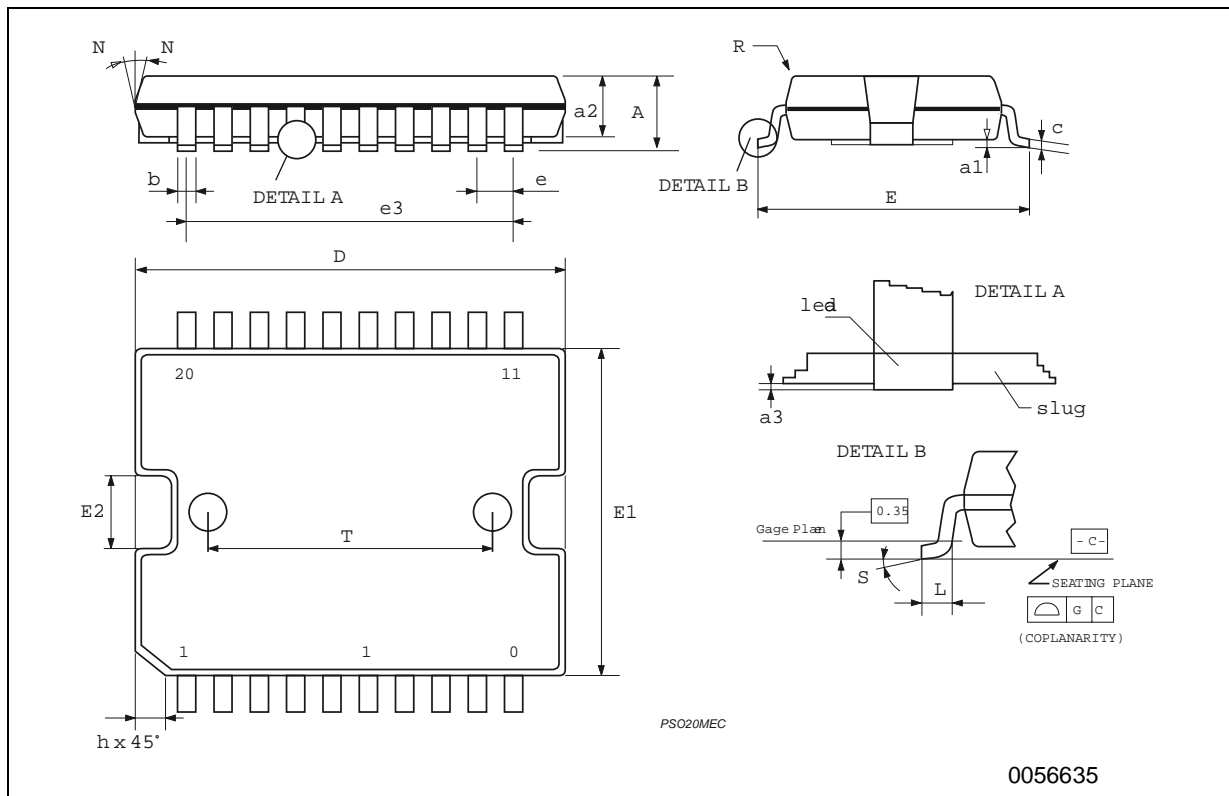


$V_{CC}=12V$ ,  $I_O=50mA$ ,  $EN=1$ , Tone enabled by DSQIN Pin

**PowerSO-20 MECHANICAL DATA**

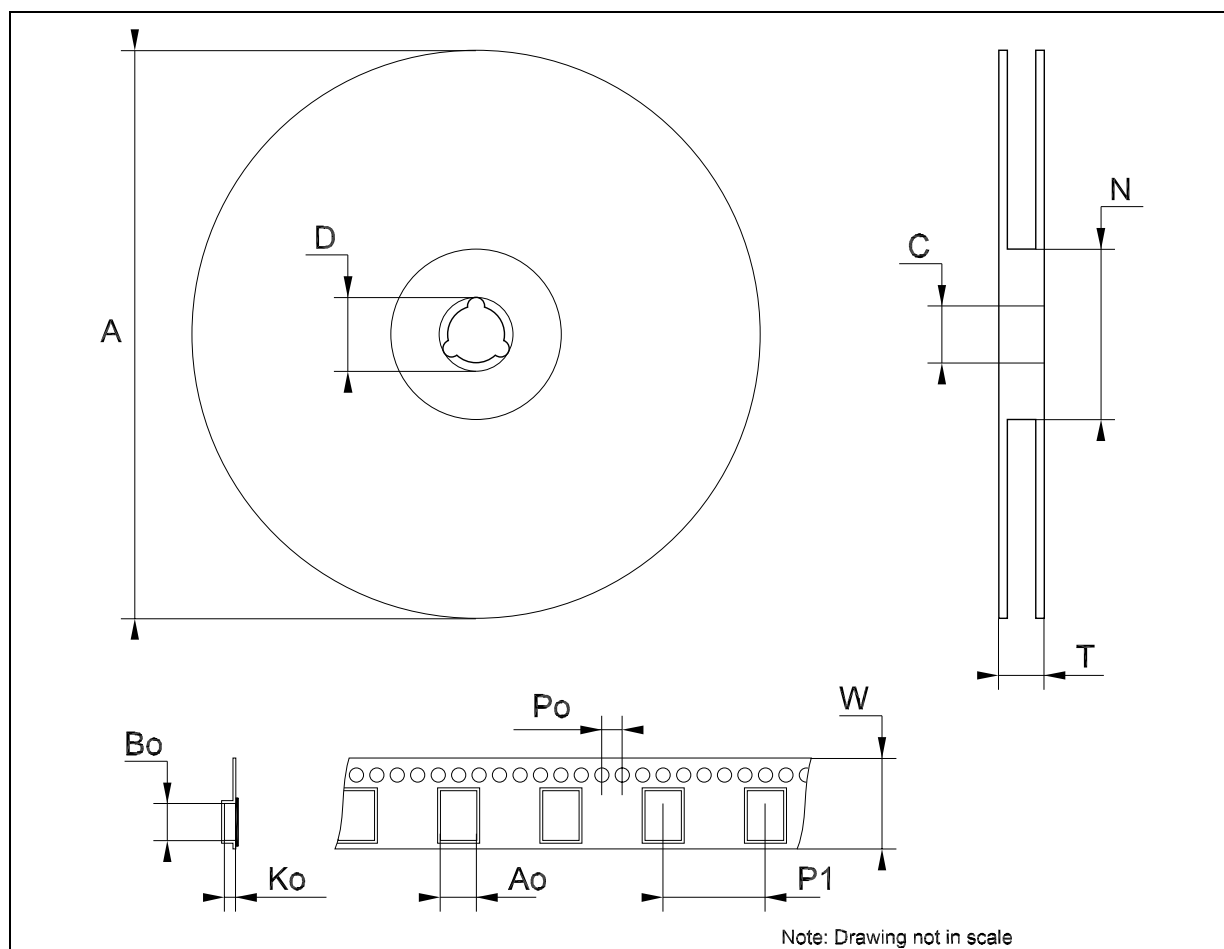
DIM.	mm.			inch		
	MIN.	TYP.	MAX.	MIN.	TYP.	MAX.
A			3.60			0.1417
a1	0.10		0.30	0.0039		0.0118
a2			3.30			0.1299
a3	0		0.10	0		0.0039
b	0.40		0.53	0.0157		0.0209
c	0.23		0.32	0.0090		0.0013
D (1)	15.80		16.00	0.6220		0.630
E	13.90		14.50	0.5472		0.5710
e		1.27			0.0500	
e3		11.43			0.4500	
E1 (1)	10.90		11.10	0.4291		0.4370
E2			2.90			0.1141
G	0		0.10	0.0000		0.0039
h			1.10			0.0433
L	0.80		1.10	0.0314		0.0433
N			10°			10°
S	0°		8°	0°		8°
T		10.0			0.3937	

(1) "D and E1" do not include mold flash or protusions - Mold flash or protusions shall not exceed 0.15mm (0.006")



### Tape & Reel PowerSO-20 MECHANICAL DATA

DIM.	mm.			inch		
	MIN.	TYP	MAX.	MIN.	TYP.	MAX.
A			330			12.992
C	12.8		13.2	0.504		0.519
D	20.2			0.795		
N	60			2.362		
T			30.4			1.197
Ao	15.1		15.3	0.594		0.602
Bo	16.5		16.7	0.650		0.658
Ko	3.8		4.0	0.149		0.157
Po	3.9		4.1	0.153		0.161
P	23.9		24.1	0.941		0.949
W	23.7		24.3	0.933		0.957



Information furnished is believed to be accurate and reliable. However, STMicroelectronics assumes no responsibility for the consequences of use of such information nor for any infringement of patents or other rights of third parties which may result from its use. No license is granted by implication or otherwise under any patent or patent rights of STMicroelectronics. Specifications mentioned in this publication are subject to change without notice. This publication supersedes and replaces all information previously supplied. STMicroelectronics products are not authorized for use as critical components in life support devices or systems without express written approval of STMicroelectronics.

The ST logo is a registered trademark of STMicroelectronics  
All other names are the property of their respective owners

© 2004 STMicroelectronics - All Rights Reserved  
STMicroelectronics GROUP OF COMPANIES

Australia - Belgium - Brazil - Canada - China - Czech Republic - Finland - France - Germany - Hong Kong - India - Israel - Italy - Japan -  
Malaysia - Malta - Morocco - Singapore - Spain - Sweden - Switzerland - United Kingdom - United States.

<http://www.st.com>