

1-917484-5 ✓ ACTIVE

[Dynamic Series](#) | [Dynamic 3000 Series](#)

TE Internal #: 1-917484-5

Connector Contact, Receptacle, Component-to-Wire, 16 – 14 AWG

Wire Size, 1.23 – 2.27 mm<sup>2</sup> Wire Size, Tin, Reel & Box, Wire & Cable,

Dynamic 3000 Series

[View on TE.com >](#)



[Connectors](#) > [PCB Connectors](#) > [Wire-to-Board Connectors](#) > [Wire-to-Board Connector Contacts](#) >

Contact: Component To Wire; 15A, 28-14 wire size

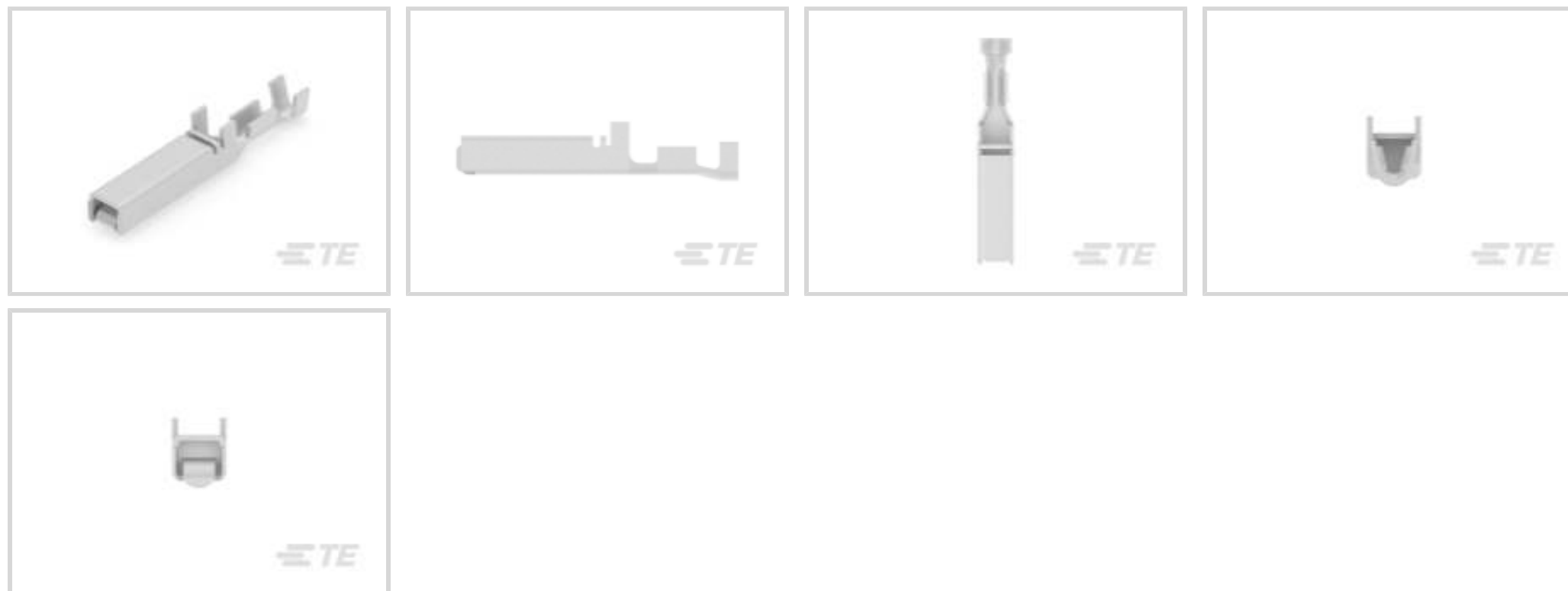

Contact Type: **Receptacle**

Connector System: **Component-to-Wire**

Wire Size: **1.23 – 2.27 mm<sup>2</sup>**

Contact Mating Area Plating Material: **Tin**

[All Contact: Component To Wire; 15A, 28-14 wire size \(91\)](#)

## Features

### Product Type Features

Connector System	Component-to-Wire
Connector & Contact Terminates To	Wire & Cable

### Contact Features

Mating Tab Width	2 mm[.08 in]
Mating Tab Thickness	.64 mm[.025 in]
Contact Type	Receptacle
Contact Mating Area Plating Material	Tin
Contact Current Rating (Max)	15 A

### Dimensions

Wire Size	1.23 – 2.27 mm <sup>2</sup>
-----------	-----------------------------

### Usage Conditions

Operating Temperature Range	-55 – 105 °C[-67 – 221 °F]
-----------------------------	----------------------------



### Operation/Application

Circuit Application	Power & Signal
---------------------	----------------

### Packaging Features

Packaging Method	Reel & Box
------------------	------------

### Product Compliance

[For compliance documentation, visit the product page on TE.com>](#)

EU RoHS Directive 2011/65/EU	Compliant
EU ELV Directive 2000/53/EC	Compliant
China RoHS 2 Directive MIIT Order No 32, 2016	No Restricted Materials Above Threshold
EU REACH Regulation (EC) No. 1907/2006	Current ECHA Candidate List: JUNE 2023 (235) Candidate List Declared Against: JAN 2023 (233) Does not contain REACH SVHC
Halogen Content	Low Halogen - Br, Cl, F, I < 900 ppm per homogenous material. Also BFR/CFR/PVC Free
Solder Process Capability	Not applicable for solder process capability

#### Product Compliance Disclaimer

This information is provided based on reasonable inquiry of our suppliers and represents our current actual knowledge based on the information they provided. This information is subject to change. The part numbers that TE has identified as EU RoHS compliant have a maximum concentration of 0.1% by weight in homogenous materials for lead, hexavalent chromium, mercury, PBB, PBDE, DBP, BBP, DEHP, DIBP, and 0.01% for cadmium, or qualify for an exemption to these limits as defined in the Annexes of Directive 2011/65/EU (RoHS2). Finished electrical and electronic equipment products will be CE marked as required by Directive 2011/65/EU. Components may not be CE marked. Additionally, the part numbers that TE has identified as EU ELV compliant have a maximum concentration of 0.1% by weight in homogenous materials for lead, hexavalent chromium, and mercury, and 0.01% for cadmium, or qualify for an exemption to these limits as defined in the Annexes of Directive 2000/53/EC (ELV). Regarding the REACH Regulation, the information TE provides on SVHC in articles for this part number is based on the latest European Chemicals Agency (ECHA) 'Guidance on requirements for substances in articles' posted at this URL: <https://echa.europa.eu/guidance-documents/guidance-on-reach>

### Compatible Parts



TE Part # 1-917266-3  
DYNAMIC D-3200 P/MOUNT REC HSG



TE Part # CAT-D9934-A75C  
Receptacle and Tab Housing: 5.08 mm pitch, 600V



TE Part # 234168-1  
EXTRACTION TOOL(DYNAMIC D-3)



TE Part # 917249-1  
DYNAMIC D-3400F REC HSG 20P



TE Part # 178214-1  
DYNAMIC 3400 REC HSG 12P



TE Part # 2305570-1  
Strip Terminal Cutter-Side Feed-No Crimp



TE Part # CAT-ABN-SPC300025  
ENTRELEC Dynamic Pluggable SNK Series



TE Part # 2-2151119-1  
OCEAN\_2.0\_APPLICATION-S-100F110F



TE Part # 2-2151119-2  
OCEAN\_2.0\_APPLICATION-S-100F110F



TE Part # 2-2836205-1  
OCEAN\_2.0\_Application-S-100F110OV



TE Part # 2-2836205-2  
OCEAN\_2.0\_Application-S-100F110OV



TE Part # 2151119-1  
OCEAN\_2.0\_APPLICATION-S-100F110F



TE Part # 2151119-2  
OCEAN\_2.0\_APPLICATION-S-100F110F



TE Part # 2836205-1  
OCEAN\_2.0\_Application-S-100F110OV



TE Part # 2836205-2  
OCEAN\_2.0\_Application-S-100F110OV



TE Part # 7-2151119-1  
OCEAN\_2.0\_APPLICATION-S-100F110F



TE Part # 7-2151119-2  
OCEAN\_2.0\_APPLICATION-S-100F110F



TE Part # 7-2151119-7  
OCEAN\_2.0\_SPARE\_PART\_KIT-110F110F



TE Part # 7-2836205-1  
OCEAN\_2.0\_Application-S-100F110OV



TE Part # 7-2836205-2  
OCEAN\_2.0\_Application-S-100F110OV

## Also in the Series | Dynamic 3000 Series



Connector Contacts(3)



Insertion & Extraction Tools(1)



PCB Connector Keying(1)



PCB Connector Mounting(8)



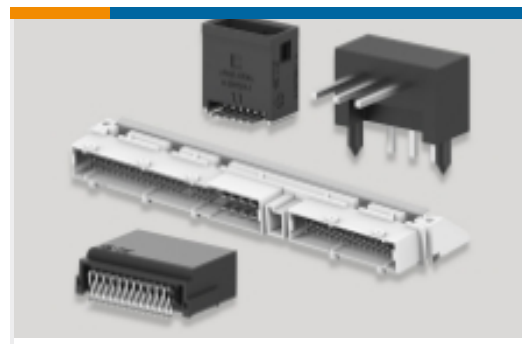

PCB Headers & Receptacles(283)

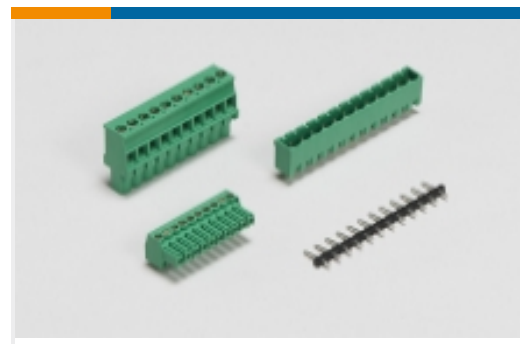

PCB Terminal Blocks(25)



Standard Rectangular Connectors(2)

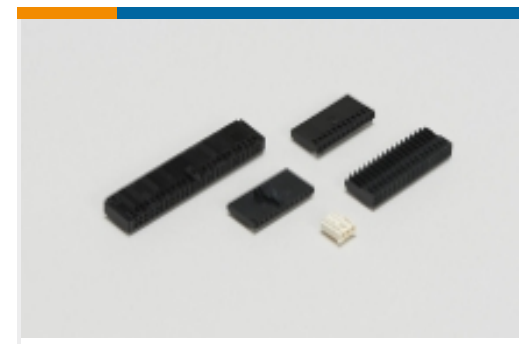

Wire-to-Board Connector Assemblies & Housings(152)



Wire-to-Board Connector Contacts(91)

## Customers Also Bought



TE Part #1-917808-3  
DYNAMIC D-5200M TAB HSG 6P X-X



TE Part #2-178129-6  
6-P DYNAMIC PLUG-H D3200 5.08



TE Part #1-178128-5  
DYNAMIC 3200 REC HSG 5P X



TE Part #1-179277-5  
DYNAMIC 3200 HDR ASSY 4P H

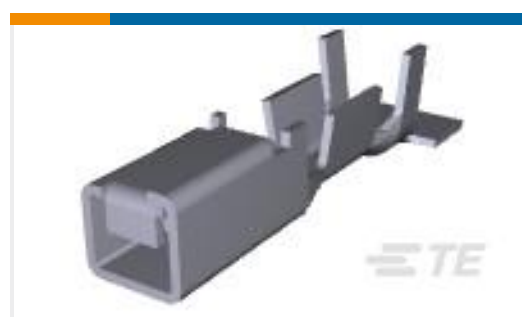

TE Part #1747418-2  
DYNAMIC D4200 REC CONT M

## Documents

### Product Drawings

[DYNAMIC D-3 REC CONT. 2L PRE-TIN](#)

English

### CAD Files

[Customer View Model](#)

[ENG\\_CVM\\_CVM\\_1-917484-5\\_Z.2d\\_dxf.zip](#)

English

[3D PDF](#)



3D

Customer View Model

[ENG\\_CVM\\_CVM\\_1-917484-5\\_Z.3d\\_igs.zip](#)

English

Customer View Model

[ENG\\_CVM\\_CVM\\_1-917484-5\\_Z.3d\\_stp.zip](#)

English

By downloading the CAD file I accept and agree to the [Terms and Conditions](#) of use.

---

### Datasheets & Catalog Pages

[1-1773732-4\\_DYNAMIC\\_SERIES\\_CATALOG\\_ENGLISH](#)

Japanese

[1-1773732-4\\_DYNAMIC\\_SERIES\\_CATALOG\\_ENGLISH](#)

English

---

### Product Specifications

[Application Specification](#)

English

---

### Product Environmental Compliance

[Product Compliance](#)

English

[Product Compliance](#)

English

---

### Instruction Sheets

[Instruction Sheet \(non U.S.\)](#)

English

---

### Agency Approvals

[TUV Certificate](#)

English

[TUV Certificate](#)

English