

EIA -Based VectorPak™ Subrack Systems

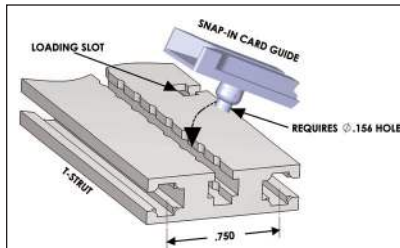

CCA13S/90 - Assembled Subrack with 21 pairs on Snap-in Guides



Snap-in Guide and TS169-6/90 Strut

VectorPak™ Card Rack Systems

Card Racks with Snap-In Guides for 0.062" thick PCBs. Guides positions can be adjusted in 0.250" horizontal increments. 0.80" thick brushed aluminum side plates with clear irridite finish. Rear "T"-Struts included for mounting of connectors (Vector P/N HD34).

Assembled Part No.	Rack Outer Dimensions (H x W x D)	Description	Kit
2U Rack CCA10S/90	Card height min. 0.75" to 2.75" max. X 6.5" L 2U (3.50") X 19.0" X 12.0"	21 pair snap-in guides installed	CCK10S/90
3U Rack CCA12S/90	Card height min. 2.50" to 4.50" max. X 4.5 L 3U (5.25") X 19.0" X 9.0"	21 pair snap-in guides installed	CCK12S/90
3U Rack CCA13S/90	Card height min. 2.50" to 4.50" max. X 6.5" L 3U (5.25") X 19.0" X 9.0"	21 pair snap-in guides installed	CCK13S/90
CCA13S-H/90	3U (5.25") X 10.25"W X 9.0"	11 pair snap-in guides w/ rack ears	CCK13S-H/90
CCA13S-HT/90	3U (5.25") X 10.25"W X 9.0"	11 pair snap-in guides, no rack ears	CCK13S-HT/90
3U Rack CCA14S/90	Card height min 2.50" to 4.50" max. X 9.6" L 3U (5.25") X 19.0" X 12.0"	21 pair snap-in guides installed	CCK14S/90
CCA14S-H/90	3U (5.25") X 10.25"W X 12.0"	11 pair snap-in guides w/ rack ears	CCK14S-H/90
4U Rack CCA15S/90	Card height 4.25" min. to 6.25" max. X 9.6"L 4U (7.00") X 19.0" X 12.0"	21 pair snap-in guides installed	CCK15S/90
5U Rack CCA17S/90	Card height min. 6.00" to 8.00" max. X 9.6" L 5U (8.75") X 19.0" X 12.0"	21 pair snap-in guides installed	CCK17S/90
7U Rack CCA100S/90	Card height min. 9.50" to 11.50" max. X 6.5" L 7U (12.25") X 19.0" X 9.0"	21 pair snap-in guides installed	CCK100S/90



CCA13M/90 with Screw-in guides

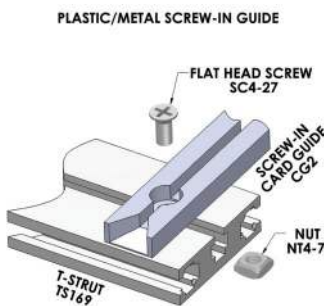

VectorPak™ Card Rack Systems

Card Racks with Screw-in Guides for 0.062" thick PCBs. Guides positions can be adjusted horizontally with NO RESTRICTIONS. "P" version is plastic guides; "M" version is metal (Die-cast Zinc or Aluminum). 0.80" thick brushed aluminum side plates with clear irridite finish. Rear "T"-Struts included for mounting of connectors (Vector P/N HD34).

Assembled Part No.	Rack Outer Dimensions (H x W x D)	Description	Kit
2U Rack CCA10P/90	Card height min. 0.75" to 2.75" max. X 6.5" L 2U (3.50") X 19.0" X 12.0"	21 pair screw-in Plastic guides installed	CCK10P/90
CCA10M/90	Same	21 pair screw-in Die-Cast Zinc guides	CCK10M/90
3U Rack CCA12P/90	Card height min. 2.50" to 4.50" max. X 4.5 L 3U (5.25") X 19.0" X 9.0"	21 pair screw-in Plastic guides installed	CCK12P/90
CCA12M/90	Same	21 pair screw-in Die-Cast Zinc guides	CCK12M/90
3U Rack CCA13P/90	Card height min. 2.50" to 4.50" max. X 6.5" L 3U (5.25") X 19.0" X 9.0"	21 pair screw-in Plastic guides installed	CCK13P/90
CCA13P-H/90	3U (5.25") X 10.25"W X 9.0" w/flanges	11 pair screw-in Plastic w / rack ears	CCK13P-H/90
CCA13P-HT/90	3U (5.25") X 8.25"W X 9.0" no flanges	11 pair screw-in Plastic no rack ears	CCK13P-HT/90
CCA13M/90	3U (5.25") X 19.0" X 9.0"	21 pair screw-in Die-Cast Zinc guides	CCK13M/90
CCA13M-H/90	3U (5.25") X 10.25"W X 9.0" w/flanges	11 pair screw-in Die-Cast Zinc guides	CCK13M-H/90
CCA13M-HT/90	3U (5.25") X 8.25"W X 9.0" no flanges	11 pair screw-in Die-Cast Zinc guides	CCK13M-HT/90
3U Rack CCA14P/90	Card height min 2.50" to 4.50" max. X 9.6" L 3U (5.25") X 19.0" X 12.0"	21 pair screw-in Plastic guides installed	CCK14P/90
CCA14M-H/90	3U (5.25") X 10.25"W X 12.0" w/flanges	21 pair screw-in Aluminum guides	CCK14M-H/90
3U Rack CCA16P/90	Card height min 2.50" to 4.50" max. X 13.5" L 3U (5.25") X 19.0" X 15.75"	21 pair screw-in Plastic guides installed	CCK16P/90
4U Rack CCA15P/90	Card height 4.25" min. to 6.25" max. X 9.6"L 4U (7.00") X 19.0" X 12.0"	21 pair screw-in Plastic guides installed	CCK15P/90
CCA15M/90	Same	21 pair screw-in Aluminum guides	CCK15M/90
4U Rack CCA20P/90	Card height min. 4.25" to 6.25" max. X 13.5 L 4U (7.00") X 19.0" X 15.75"	21 pair screw-in Plastic guides installed	CCK20P/90
CCA20M/90	Same	21 pair screw-in Aluminum guides	CCK20M/90
5U Rack CCA17P/90	Card height min. 6.00" to 8.00" max. X 9.6" L 5U (8.75") X 19.0" X 12.0"	21 pair screw-in Plastic guides installed	CCK17P/90
CCA17M/90	Same	21 pair screw-in Aluminum guides	CCK17M/90
6U Rack CCA18P/90	Card height min. 7.75" to 9.750" max. X 13.5 L 6U (10.50") X 19.0" X 15.75"	21 pair screw-in Plastic guides installed	CCK18P/90
CCA18M/90	Same	21 pair screw-in Aluminum guides	CCK18M/90
7U Rack CCA19P/90	Card height min. 9.50" to 11.50" max. X 13.5"L 7U (12.25") X 19.0" X 15.75"	21 pair screw-in Plastic guides installed	CCK19P/90
CCA19M/90	Same	21 pair screw-in Aluminum guides	CCK19M/90

EIA Subracks

