

## A 1 $\mu$ A, SOT23 Precision Current-Sense Amplifier

### FEATURES

- ◆ Second-source for MAX9634F
- ◆ Ultra-Low Supply Current: 1 $\mu$ A
- ◆ Wide Input Common Mode Range: +1.6V to +28V
- ◆ Low Input Offset Voltage: 250 $\mu$ V (max)
- ◆ Low Gain Error: <0.5% (max)
- ◆ Voltage Output
- ◆ Gain Option Available:
  - TSM9634F: Gain = 50V/V
- ◆ 5-Pin SOT23 Packaging

### APPLICATIONS

Notebook Computers  
 Power Management Systems  
 Portable/Battery-Powered Systems  
 PDAs  
 Smart Phones

### DESCRIPTION

The voltage-output TSM9634F current-sense amplifier are electrically and form-factor identical to the MAX9634F current-sense amplifier. Consuming a very low 1 $\mu$ A supply current, the TSM9634F high-side current-sense amplifiers exhibit a 250- $\mu$ V (max)  $V_{OS}$  and a 0.5% (max) gain error, both specifications optimized for any precision current measurement. For all high-side current-sensing applications, the TSM9634F features a wide input common-mode voltage range from 1.6V to 28V.

The SOT23 package makes the TSM9634F an ideal choice for pcb-area-critical, low-current, high-accuracy current-sense applications in all battery-powered portable instruments.

All TSM9634Fs are specified for operation over the -40 $^{\circ}$ C to +85 $^{\circ}$ C extended temperature range.

### TYPICAL APPLICATION CIRCUIT

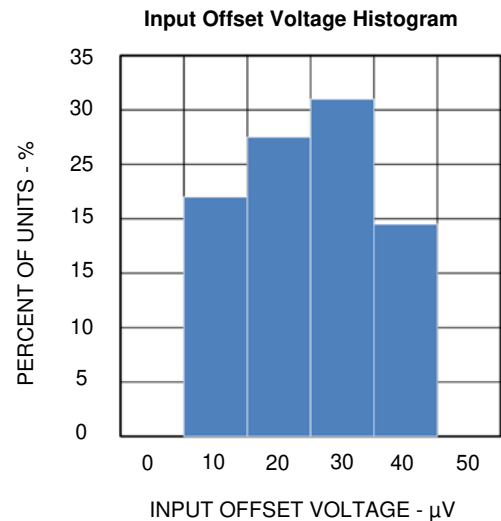
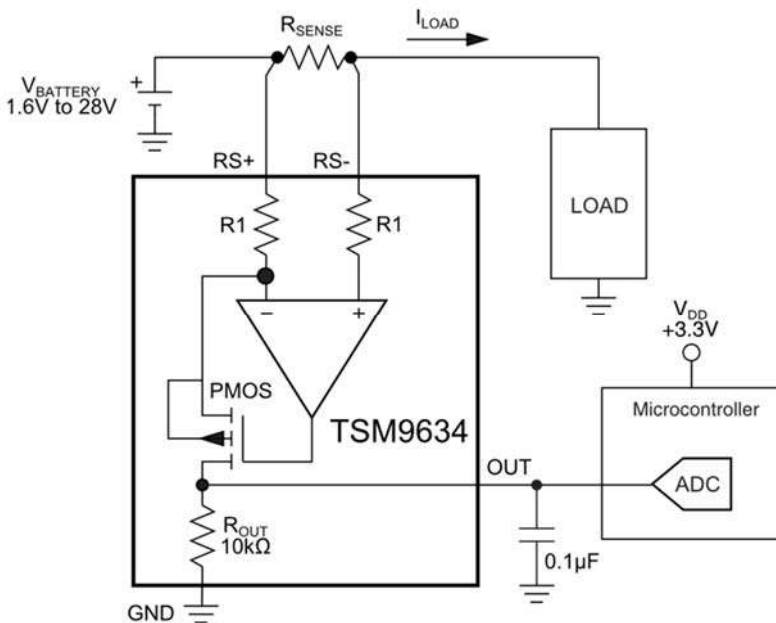

## ABSOLUTE MAXIMUM RATINGS

RS+, RS- to GND- ..... -0.3V to +30V  
 OUT to GND- ..... -0.3V to +6V  
 RS+ to RS- ..... ±30V  
 Short-Circuit Duration: OUT to GND ..... Continuous  
 Continuous Input Current (Any Pin) ..... ±20mA  
 Continuous Power Dissipation (T<sub>A</sub> = +70°C)  
 5-Pin SOT23 (Derate at 3.9mW/°C above +70°C).. 312mW

Operating Temperature Range ..... -40°C to +85°C  
 Junction Temperature ..... +150°C  
 Storage Temperature Range ..... -65°C to +150°C  
 Lead Temperature (Soldering, 10s) ..... +300°C  
 Soldering Temperature (Reflow) ..... +260°C

Electrical and thermal stresses beyond those listed under “Absolute Maximum Ratings” may cause permanent damage to the device. These are stress ratings only and functional operation of the device at these or any other condition beyond those indicated in the operational sections of the specifications is not implied. Exposure to any absolute maximum rating conditions for extended periods may affect device reliability and lifetime.

## PACKAGE/ORDERING INFORMATION

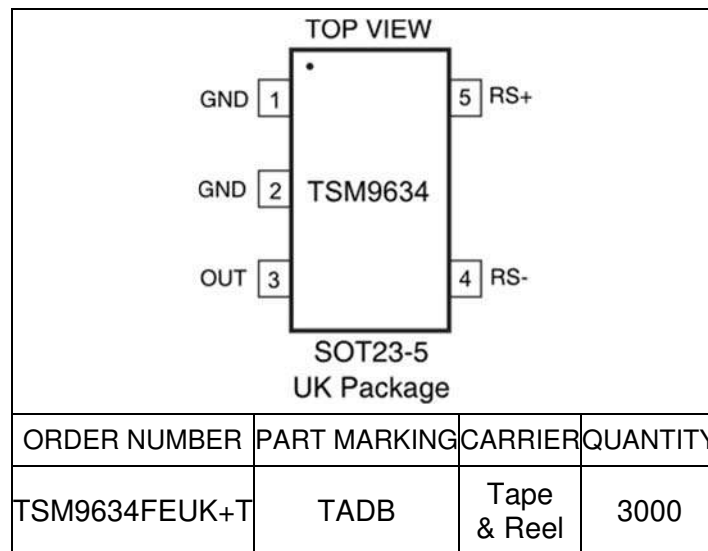

**Lead-free Program:** Silicon Labs supplies only lead-free packaging.

Consult Silicon Labs for products specified with wider operating temperature ranges.

## ELECTRICAL CHARACTERISTICS

$V_{RS+} = V_{RS-} = 3.6V$ ;  $V_{SENSE} = (V_{RS+} - V_{RS-}) = 0V$ ;  $T_A = -40^{\circ}C$  to  $+85^{\circ}C$ , unless otherwise noted. Typical values are at  $T_A = +25^{\circ}C$ . See Note 1

PARAMETER	SYMBOL	CONDITIONS	MIN	TYP	MAX	UNITS
Supply Current (Note 2)	$I_{CC}$	$V_{RS+} = 5V, T_A = +25^{\circ}C$		0.5	0.85	$\mu A$
		$V_{RS+} = 5V, -40^{\circ}C < T_A < +85^{\circ}C$			1.1	
		$V_{RS+} = 28V, T_A = +25^{\circ}C$		1.1	1.8	
		$V_{RS+} = 28V, -40^{\circ}C < T_A < +85^{\circ}C$			2.5	
Common-Mode Input Range	$V_{CM}$	Guaranteed by CMRR, $-40^{\circ}C < T_A < +85^{\circ}C$	1.6		28	V
Common-Mode Rejection Ratio	CMRR	$1.6V < V_{RS+} < 28V, -40^{\circ}C < T_A < +85^{\circ}C$	94	130		dB
Input Offset Voltage (Note 3)	$V_{OS}$	$T_A = +25^{\circ}C$		100	250	$\mu V$
		$-40^{\circ}C < T_A < +85^{\circ}C$			300	
Gain	G			50		V/V
Gain Error (Note 4)	GE	$T_A = +25^{\circ}C$		$\pm 0.1$	$\pm 0.5$	%
		$-40^{\circ}C < T_A < +85^{\circ}C$			$\pm 0.6$	
Output Resistance	$R_{OUT}$	(Note 5)	7.0	10	13.2	k $\Omega$
OUT Low Voltage	$V_{OL}$	Gain = 50		3	15	mV
OUT High Voltage	$V_{OH}$	$V_{OH} = V_{RS-} - V_{OUT}$ (Note 6)		0.1	0.2	V

**Note 1:** All devices are 100% production tested at  $T_A = +25^{\circ}C$ . All temperature limits are guaranteed by product characterization.

**Note 2:** Extrapolated to  $V_{OUT} = 0$ .  $I_{CC}$  is the total current into the  $RS+$  and the  $RS-$  pins.

**Note 3:** Input offset voltage  $V_{OS}$  is extrapolated from  $V_{OUT}$  with  $V_{SENSE}$  set to 1mV.

**Note 4:** Gain error is calculated by applying two values for  $V_{SENSE}$  and then calculating the error of the actual slope vs. the ideal transfer characteristic:

For GAIN = 50, the applied  $V_{SENSE}$  is 10mV and 60mV.

**Note 5:** The device is stable for any capacitive load at  $V_{OUT}$ .

**Note 6:**  $V_{OH}$  is the voltage from  $V_{RS-}$  to  $V_{OUT}$  with  $V_{SENSE} = 3.6V/GAIN$ .

## TYPICAL PERFORMANCE CHARACTERISTICS

$V_{RS+} = V_{RS-} = 3.6V$ ;  $T_A = +25^{\circ}C$ , unless otherwise noted.

Input Offset Voltage Histogram

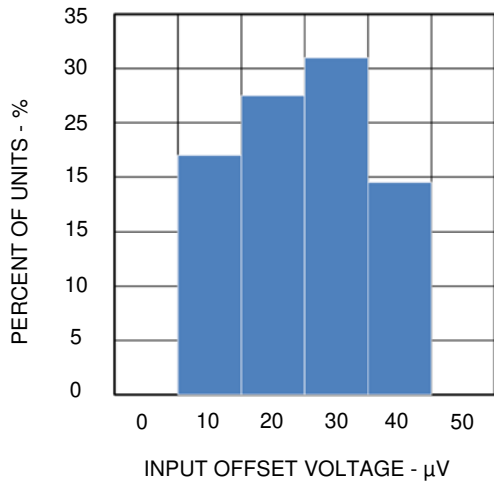

Gain Error Histogram

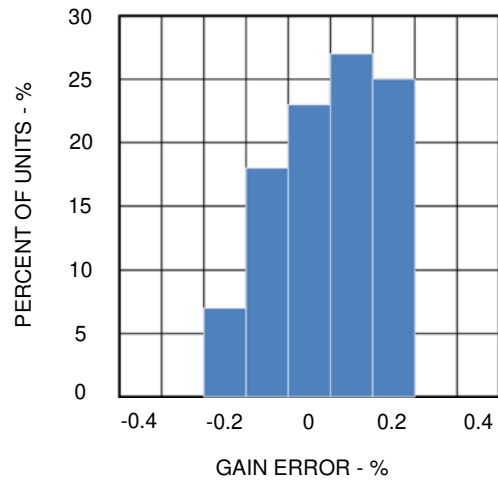

Supply Current vs Temperature

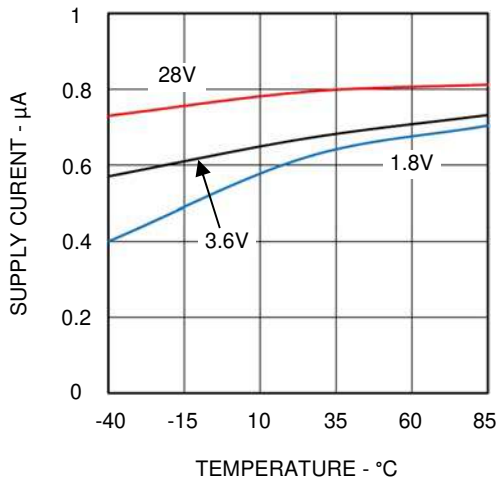

Input Offset Voltage vs Common-Mode Voltage

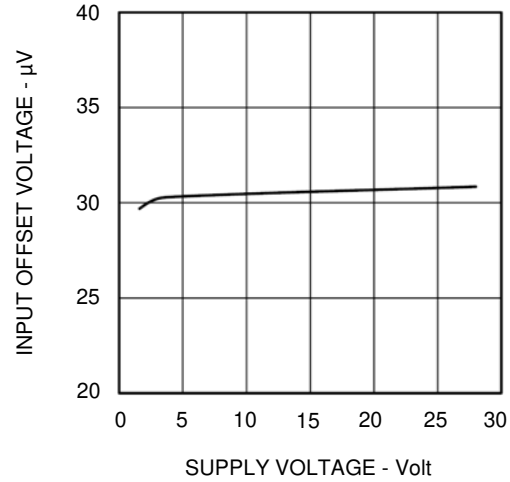

Input Offset Voltage vs Temperature

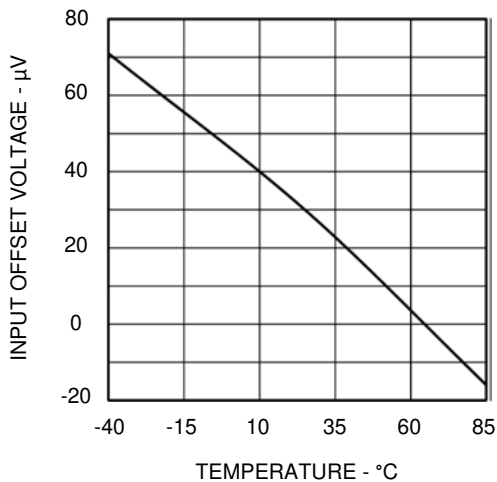

Supply Current vs Common-Mode Voltage

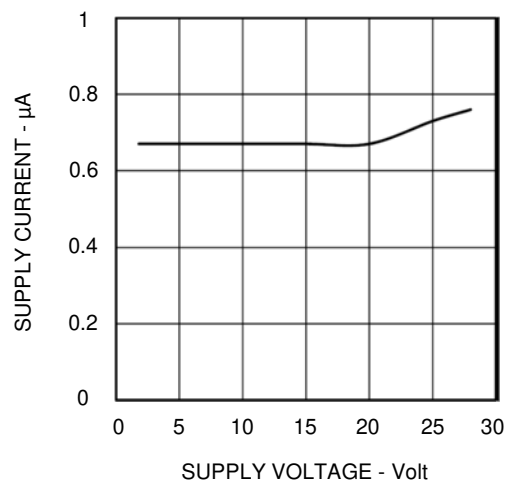



SILICON LABS

TSM9634F

# TYPICAL PERFORMANCE CHARACTERISTICS

$V_{RS+} = V_{RS-} = 3.6V$ ;  $T_A = +25^\circ C$ , unless otherwise noted.

Gain Error vs Common-Mode Voltage

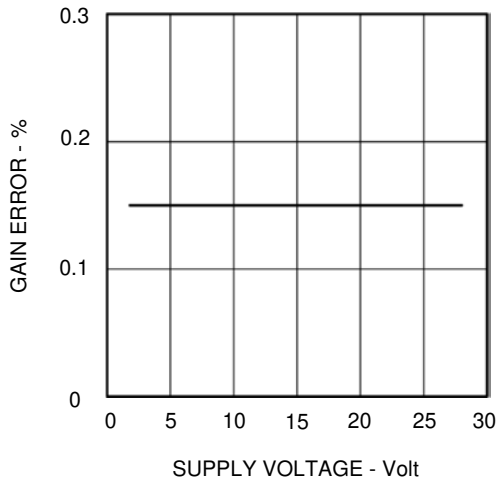

Gain Error vs. Temperature

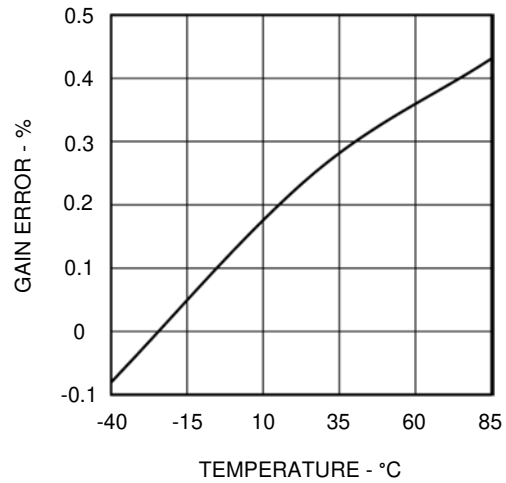

$V_{OUT}$  vs  $V_{SENSE}$  @ Supply = 3.6V

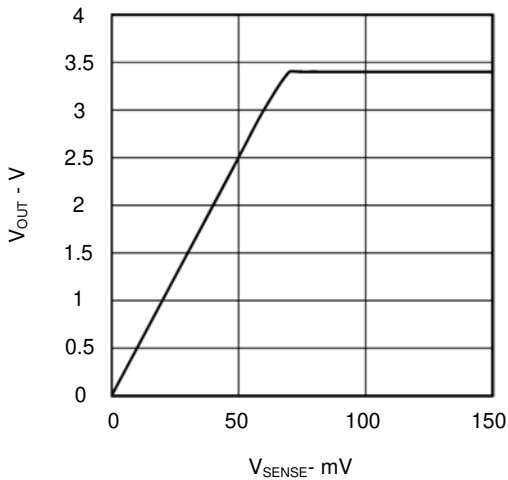

$V_{OUT}$  vs  $V_{SENSE}$  @ Supply = 1.6V

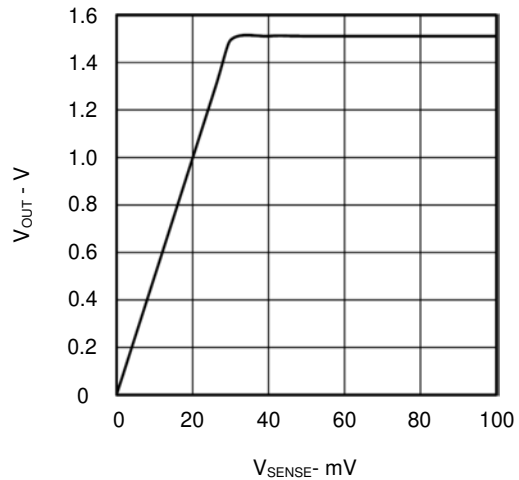

Small-Signal Gain vs Frequency

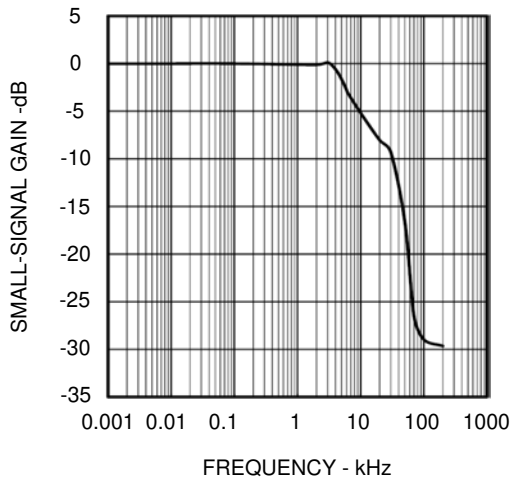

Common-Mode Rejection vs Frequency

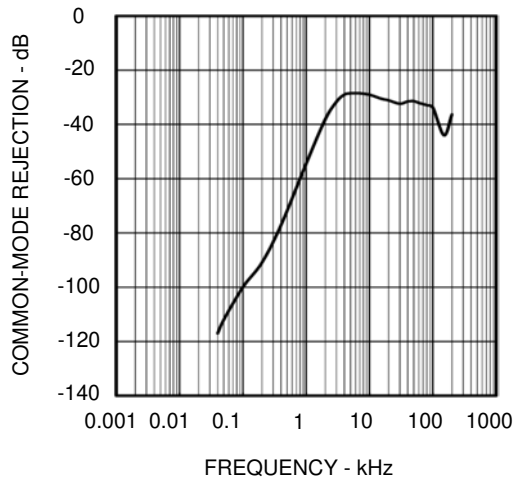

## TYPICAL PERFORMANCE CHARACTERISTICS

$V_{RS+} = V_{RS-} = 3.6V$ ;  $T_A = +25^{\circ}C$ , unless otherwise noted.

Small-Signal Pulse Response, Gain = 50

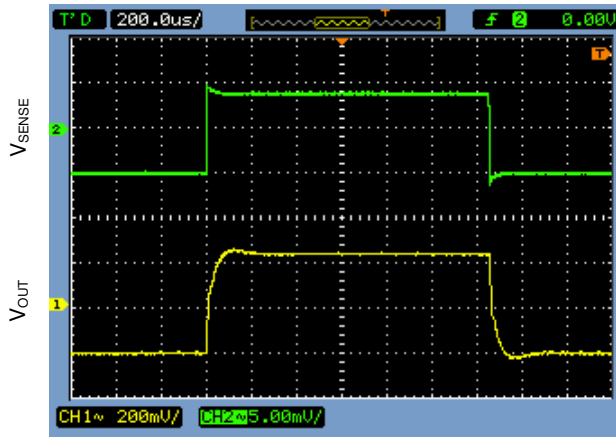

200μs/DIV

Large-Signal Pulse Response, Gain = 50

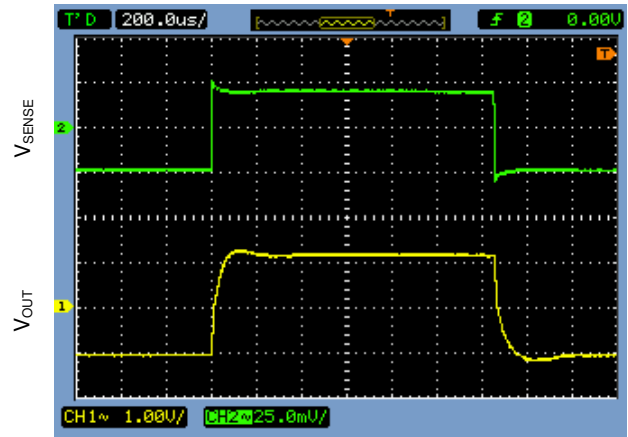

200μs/DIV

## PIN FUNCTIONS

PIN SOT23	LABEL	FUNCTION
5	RS+	External Sense Resistor Power-Side Connection
4	RS-	External Sense Resistor Load-Side Connection
1, 2	GND	Ground. Connect this pin to analog ground.
3	OUT	Output Voltage. $V_{OUT}$ is proportional to $V_{SENSE} = V_{RS+} - V_{RS-}$ .

## BLOCK DIAGRAMS

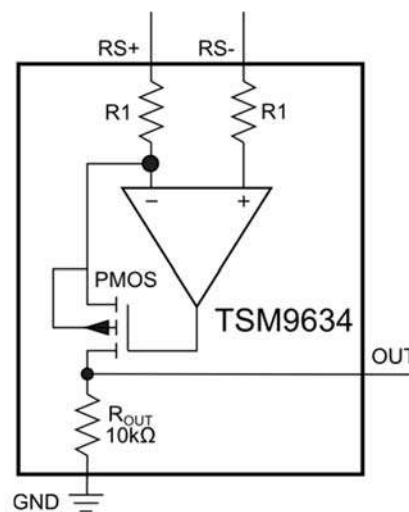

## DESCRIPTION OF OPERATION

The internal configuration of the TSM9634F – a unidirectional high-side, current-sense amplifier - is based on a commonly-used operational amplifier (op amp) circuit for measuring load currents (in one direction) in the presence of high-common-mode voltages. In the general case, a current-sense amplifier monitors the voltage caused by a load current through an external sense resistor and generates an output voltage as a function of that load current. Referring to the typical application circuit on Page 1, the inputs of the op-amp-based circuit are connected across an external RSENSE resistor that is used to measure load current. At the non-inverting input of the TSM9634F (the RS- terminal), the applied voltage is  $I_{LOAD} \times RSENSE$ . Since the RS- terminal is the non-inverting input of the internal op amp, op-amp feedback action forces the inverting input of the internal op amp to the same potential ( $I_{LOAD} \times RSENSE$ ). Therefore, the voltage drop across

RSENSE ( $V_{SENSE}$ ) and the voltage drop across R1 (at the RS+ terminal) are equal. To minimize any additional error because of op-amp input bias current mismatch, both R1s are the same value.

Since the internal p-channel FET's source is connected to the inverting input of the internal op amp and since the voltage drop across R1 is the same as the external  $V_{SENSE}$ , op amp feedback action drives the gate of the FET such that the FET's drain current is equal to:

$$I_{DS} = \frac{V_{SENSE}}{R1}$$

or

$$I_{DS} = \frac{I_{LOAD} \times R_{SENSE}}{R1}$$

Since the FET's drain terminal is connected to ROUT, the output voltage of the TSM9634F at the OUT terminal is, therefore;

$$V_{OUT} = I_{LOAD} \times R_{SENSE} \times \frac{R_{OUT}}{R1}$$

The current-sense amplifier's gain accuracy is therefore the ratio match of ROUT to R1. Table 1

lists the values for ROUT and R1. The TSM9634F's output stage is protected against input overdrive by use of an output current-limiting circuit of 3mA (typical) and a 7V internal clamp protection circuit.

**Table 1: Internal Gain Setting Resistors (Typical Values)**

GAIN (V/V)	R1 (Ω)	ROUT (Ω)	Part Number
50	200	10k	TSM9634F

## APPLICATIONS INFORMATION

### Choosing the Sense Resistor

Selecting the optimal value for the external RSENSE is based on the following criteria and for each commentary follows:

- 1) RSENSE Voltage Loss
- 2) VOUT Swing vs. Applied Input Voltage at VRS+ and Desired VSENSE
- 3) Total ILOAD Accuracy
- 4) Circuit Efficiency and Power Dissipation
- 5) RSENSE Kelvin Connections

#### 1) RSENSE Voltage Loss

For lowest IR voltage loss in RSENSE, the smallest usable value for RSENSE should be selected.

#### 2) VOUT Swing vs. Applied Input Voltage at VRS+ and Desired VSENSE

As there is no separate power supply pin for the TSM9634F, the circuit draws its power from the applied voltage at both its RS+ and RS- terminals. Therefore, the signal voltage at the OUT terminal is bounded by the minimum supply voltage applied to the TSM9634F.

Therefore,

$$V_{OUT(max)} = V_{RS+(min)} - V_{SENSE(max)} - V_{OH(max)}$$

and

$$R_{SENSE} = \frac{V_{OUT(max)}}{GAIN \times I_{LOAD(max)}}$$

where the full-scale VSENSE should be less than VOUT/GAIN at the application's minimum RS+ terminal voltage. For best performance with a 3.6V power supply, RSENSE should be chosen to generate a VSENSE of 60mV at the full-scale ILOAD current in each application. For the case where the minimum power supply voltage is higher than 3.6V, the full-scale VSENSE above can be increased.

#### 3) Total Load Current Accuracy

In the TSM9634F's linear region where  $V_{OUT} < V_{OUT(max)}$ , there are two specifications related to the circuit's accuracy: a) the TSM9634F's input offset voltage ( $V_{OS} = 250\mu V, max$ ) and b) its gain error ( $GE(max) = 0.5%$ ). An expression for the TSM9634F's total error is given by:

$$V_{OUT} = [GAIN \times (1 \pm GE) \times V_{SENSE}] \pm (GAIN \times V_{OS})$$

A large value for RSENSE permits the use of smaller load currents to be measured more accurately because the effects of offset voltages are less significant when compared to larger VSENSE voltages. Due care though should be exercised as



previously mentioned with large values of RSENSE.

#### 4) Circuit Efficiency and Power Dissipation

IR losses in RSENSE can be large especially at high load currents. It is important to select the smallest, usable RSENSE value to minimize power dissipation and to keep the physical size of RSENSE small. If the external RSENSE is allowed to dissipate significant power, then its inherent temperature coefficient may alter its design center value, thereby reducing load current measurement accuracy. Precisely because the TSM9634F's input stage was designed to exhibit a very low input offset voltage, small RSENSE values can be used to reduce power dissipation and minimize local hot spots on the pcb.

#### 5) RSENSE Kelvin Connections

For optimal VSENSE accuracy in the presence of large load currents, parasitic pcb track resistance should be minimized. Kelvin-sense pcb connections

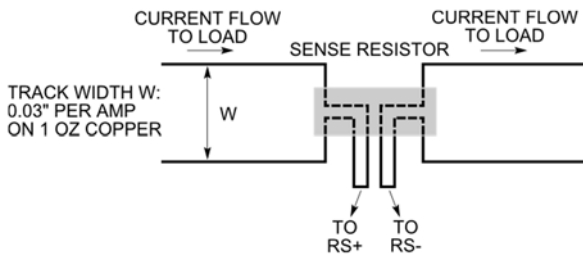

**Figure 1:** Making PCB Connections to the Sense Resistor (drawing is not to scale).

between RSENSE and the TSM9634F's RS+ and RS- terminals are strongly recommended. The drawing in Figure 1 illustrates the connections between the current-sense amplifier and the current-sense resistor. The pcb layout should be balanced and symmetrical to minimize wiring-induced errors. In addition, the pcb layout for RSENSE should include good thermal management techniques for optimal RSENSE power dissipation.

#### Optional Output Filter Capacitor

If the TSM9634F is part of a signal acquisition system where its OUT terminal is connected to the input of an ADC with an internal, switched-capacitor track-and-hold circuit, the internal track-and-hold's sampling capacitor can cause voltage droop at VOUT. A 22nF to 100nF good-quality ceramic capacitor from the OUT terminal to GND should be used to minimize voltage droop (holding VOUT constant during the sample interval). Using a capacitor on the OUT terminal will also reduce the TSM9634F's small-signal bandwidth as well as band-limiting amplifier noise.

#### Using the TSM9634F in Bidirectional Load Current Applications

In many battery-powered systems, it is oftentimes necessary to monitor a battery's discharge and charge currents. To perform this function, a bidirectional current-sense amplifier is required. The circuit illustrated in Figure 2 shows how two TSM9634Fs can be configured as a bidirectional current-sense amplifier. As shown in the figure, the

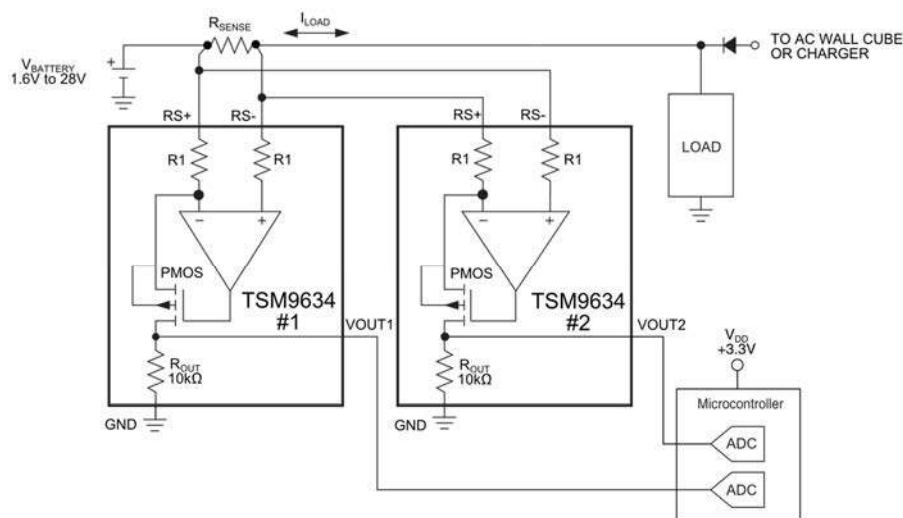

**Figure 2:** Using Two TSM9634Fs for Bidirectional Load Current Detection

RS+/RS- input pair of TSM9634F #2 is wired opposite in polarity with respect to the RS+/RS- connections of TSM9634F #1. Current-sense amplifier #1 therefore measures the discharge current and current-sense amplifier #2 measures the charge current. Note that both output voltages are measured with respect to GND. When the discharge current is being measured,  $V_{OUT1}$  is active and  $V_{OUT2}$  is zero; for the case where charge current is being measured,  $V_{OUT1}$  is zero, and  $V_{OUT2}$  is active.

## PC Board Layout and Power-Supply Bypassing

For optimal circuit performance, the TSM9634F should be in very close proximity to the external current-sense resistor and the pcb tracks from RSENSE to the RS+ and the RS- input terminals of the TSM9634F should be short and symmetric. Also recommended are a ground plane and surface mount resistors and capacitors.



SILICON LABS

TSM9634F

# PACKAGE OUTLINE DRAWING

## 5-Pin SOT23 Package Outline Drawing

(N.B., Drawings are not to scale)

### NOTES:

1. Dimensions and tolerances are as per ANSI Y14.5M, 1982.
2. Package surface to be matte finish VDI 11~13.
3. Die is facing up mold and facing down for trim/form, ie, reverse trim/form.
4. The foot length measuring is based on the gauge plane method.
5. Dimensions are exclusive of mold flash and gate burr.
6. Dimensions are exclusive of solder plating.
7. All dimensions are in mm.
8. This part is compliant with EIAJ spec. and JEDEC MO-178 AA
9. Lead span/stand off height/coplanarity are considered as special characteristic.

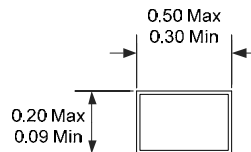
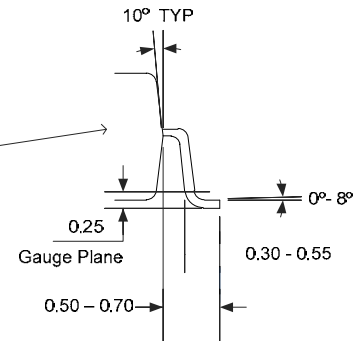
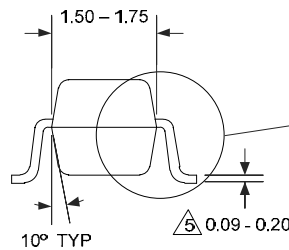
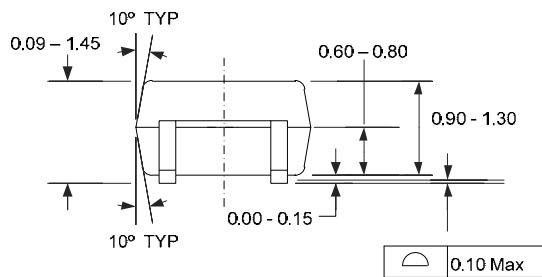
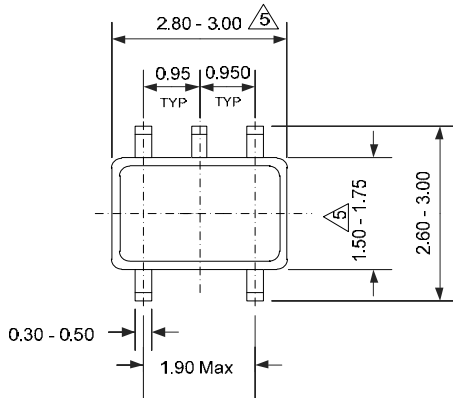

### Patent Notice

Silicon Labs invests in research and development to help our customers differentiate in the market with innovative low-power, small size, analog-intensive mixed-signal solutions. Silicon Labs' extensive patent portfolio is a testament to our unique approach and world-class engineering team.

The information in this document is believed to be accurate in all respects at the time of publication but is subject to change without notice. Silicon Laboratories assumes no responsibility for errors and omissions, and disclaims responsibility for any consequences resulting from the use of information included herein. Additionally, Silicon Laboratories assumes no responsibility for the functioning of undescribed features or parameters. Silicon Laboratories reserves the right to make changes without further notice. Silicon Laboratories makes no warranty, representation or guarantee regarding the suitability of its products for any particular purpose, nor does Silicon Laboratories assume any liability arising out of the application or use of any product or circuit, and specifically disclaims any and all liability, including without limitation consequential or incidental damages. Silicon Laboratories products are not designed, intended, or authorized for use in applications intended to support or sustain life, or for any other application in which the failure of the Silicon Laboratories product could create a situation where personal injury or death may occur. Should Buyer purchase or use Silicon Laboratories products for any such unintended or unauthorized application, Buyer shall indemnify and hold Silicon Laboratories harmless against all claims and damages.

Silicon Laboratories and Silicon Labs are trademarks of Silicon Laboratories Inc.

Other products or brandnames mentioned herein are trademarks or registered trademarks of their respective holders.

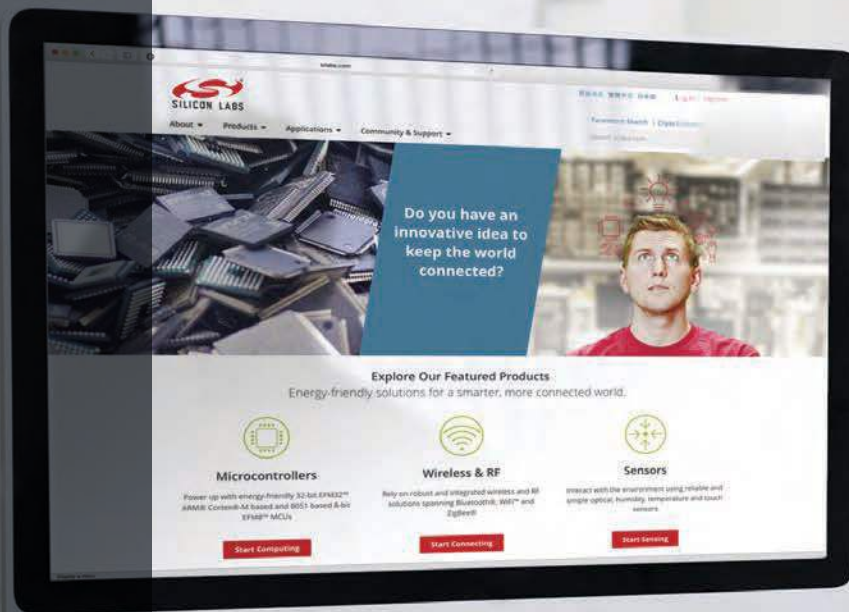

Smart.  
Connected.  
Energy-Friendly



**Products**  
[www.silabs.com/products](http://www.silabs.com/products)

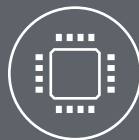

**Quality**  
[www.silabs.com/quality](http://www.silabs.com/quality)



**Support and Community**  
[community.silabs.com](http://community.silabs.com)

#### Disclaimer

Silicon Laboratories intends to provide customers with the latest, accurate, and in-depth documentation of all peripherals and modules available for system and software implementers using or intending to use the Silicon Laboratories products. Characterization data, available modules and peripherals, memory sizes and memory addresses refer to each specific device, and "Typical" parameters provided can and do vary in different applications. Application examples described herein are for illustrative purposes only. Silicon Laboratories reserves the right to make changes without further notice and limitation to product information, specifications, and descriptions herein, and does not give warranties as to the accuracy or completeness of the included information. Silicon Laboratories shall have no liability for the consequences of use of the information supplied herein. This document does not imply or express copyright licenses granted hereunder to design or fabricate any integrated circuits. The products must not be used within any Life Support System without the specific written consent of Silicon Laboratories. A "Life Support System" is any product or system intended to support or sustain life and/or health, which, if it fails, can be reasonably expected to result in significant personal injury or death. Silicon Laboratories products are generally not intended for military applications. Silicon Laboratories products shall under no circumstances be used in weapons of mass destruction including (but not limited to) nuclear, biological or chemical weapons, or missiles capable of delivering such weapons.

#### Trademark Information

Silicon Laboratories Inc., Silicon Laboratories, Silicon Labs, SiLabs and the Silicon Labs logo, CMEMS®, EFM, EFM32, EFR, Energy Micro, Energy Micro logo and combinations thereof, "the world's most energy friendly microcontrollers", Ember®, EZLink®, EZMac®, EZRadio®, EZRadioPRO®, DSPLL®, ISOmodem®, Precision32®, ProSLIC®, SiPHY®, USBXpress® and others are trademarks or registered trademarks of Silicon Laboratories Inc. ARM, CORTEX, Cortex-M3 and THUMB are trademarks or registered trademarks of ARM Holdings. Keil is a registered trademark of ARM Limited. All other products or brand names mentioned herein are trademarks of their respective holders.



Silicon Laboratories Inc.  
400 West Cesar Chavez  
Austin, TX 78701  
USA

<http://www.silabs.com>