

T H E R M O M E T R I C S
A C O M M I T M E N T T O E X C E L L E N C E

Water Detection Sensor



According to sharp growth of Electrical Vehicles (EV), many OEMs are using cooling systems for their battery pack systems. However, if an instance of water leakage were to occur in Li-ion battery packs, it would create dangerous conditions.

Thermometrics Water Detection Sensor detects moisture leakage via a change in resistance value of the sensor and feeds a signal to the Battery Management System (BMS) to warn the driver.

Applications

- Battery pack water detection
- Overflow of water/fluid
- Leak detection from a burst pipe
- Level detection on tank fill applications
- Condensate overflow sensor for HVAC applications
- Sump pumps

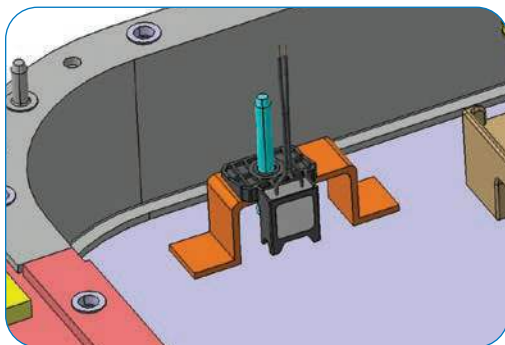

Features

- $510\text{k}\Omega \pm 3\%$
- Operating Temperature Range: -40°C to 85°C
- Easy to install
- RoHS Compliance (Directive 2011/65/EU)

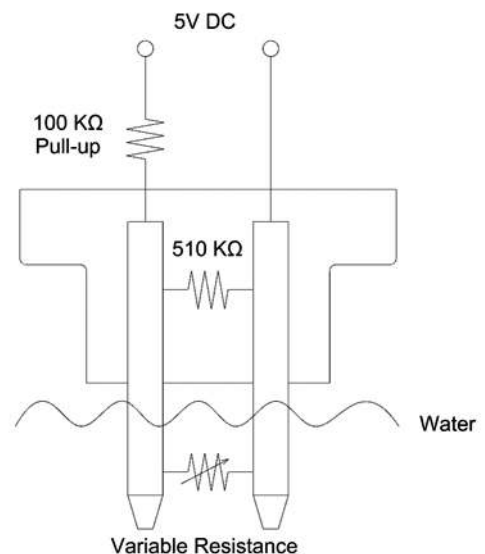

Amphenol
Advanced Sensors

Water Detection Sensor - Specifications

Parameter	Limits			Unit	Condition
	Min	Typ	Max		
Operating Temperature Range	-40		85	°C	
Resistor in Sensor	494.7	510	525.3	kΩ	1/4 Watt
Rated Power	5V DC			Voltage	Recommended
Pull-up Resistor	100			kΩ	Recommended
RoHS	Directive 2011/65/EU				

Reliability

Parameter	Criteria	Condition
High Temperature Dwell/Operation Test	After test - No deformation - No functional error - To meet requirement	- Temp: 85°C ± 3°C, 1000 hrs - Rated voltage: 5V - Check water immersion at 5V DC
Low Temperature Dwell/Operation Test	After test - No deformation - No functional error - To meet requirement	- Temp: -40°C ± 3°C, 1000 hrs - Rated voltage: 5V DC - On: 10 mins, Off: 50 mins - Check water immersion at 5V DC
High Temperature/Humidity Test (Voltage rated)	After test - No visual error - Deformation allowed at non-functional area - No functional error - To meet requirement	- Temp: 85°C ± 3°C, 1000 hrs - Humidity: 95 ~ 99 % RH - Rated voltage: 5V DC - On: 10 mins, Off: 50 mins - Check water immersion at 5V DC
Temperature/Humidity Cycle Test	After test - No functional error - To meet requirement	See Figure 1 for test condition. - Check water immersion at 5V DC - After the test, dwell specimen at room temperature more than 2 hrs
Temperature Cycle Test	During/after test - No functional error After test - To meet requirement	See Figure 2 for test condition (On: 10 min, Off: 50 min) - After test, dwell specimens at room temp. (more than 2 hrs) - Check water immersion at 5V DC
Impact Test	After test - No visual error - No functional error - To meet requirement	See Figure 3 for test condition. - Impact acceleration: 392±10% m/s ² - Impact time: 11 ms - Impact direction: +X, -X, +Y, -Y, +Z, -Z - No. of impact: 3 times (each direction) - Check water immersion at 5V DC
Drop Test	After test - No visual error - No functional error (including sealing) - To meet requirement	- Drop height: 1m (concrete or steel floor) - Drop direction: 1st: X, 2nd: -X 1. not applicable to connector direction 2. switch product to cover before drop - No. of drop: 2 times (per specimen) - Check water immersion at 5V DC
Dew Condensation Test	After test - No burning marks - No functional error - To meet requirement	See Figure 4 for test condition. - Total duration: 3 cycles - Check water immersion at 5V DC

Water Detection Sensor - Specifications (Cont.)

Parameter	Criteria	Condition
Dust Dwell Test (Not power rated)	After test (remove dust before inspection) - No functional error - To meet requirement	- Unspecified procedure to follow JIS D 0207 - Dust type: JIS Z 8901, 9 types, 3 kg - Air pressure: 294 ~ 490 kPa - Dust spray: 10 sec, every 15 mins (total test duration: 6 hrs) - Check water immersion at 5V DC
Temperature Characteristics Test	After test - To meet requirement at each temperature	- Dwell specimens at room temp. for 1 hr (not power rated) - See Figure 5 for test condition - Dwell specimens at each temperature → Test specimens at the same temperature - Rated power: 12.6 V DC (for water leak operation check) - Check water immersion at 5V DC
Salt Spray Test	After test - No functional error - No rust allowed (white rust allowed) - To meet requirement	- Salt water density: $5 \pm 1 \%$ - Salt water temp.: $35 \pm 2^{\circ}\text{C}$ - Test duration: 24 hrs - Water dispensing: mist type (1~2 ml / hr) - Check water immersion at 5V DC
Resonance Durability Test	After test - Bracket breakage * customer approval needed - No visual error - To meet requirement	1. Resonance frequency search - Frequency: 10 ~ 1000 Hz - Vibration acceleration: 9.8 m/s^2 - Vibration direction: X, Y, Z 2. Resonance durability test - See Table 1 for test condition
Vibration Durability Test 1 - Accelerated vibration at product (Indoor, trunk, door)	After test - No visual error - No functional error - To meet requirement	- Frequency: 10 ~ 1000 Hz - Acceleration: 20 m/s^2 - Duration: 8 hrs (each axis) - For vibration frequency, see Figure 6
Vibration Durability Test 2 - Accelerated vibration at part (Indoor, trunk, door)	During/after test - No functional error After test - No visual error - To meet requirement - Bracket breakage * customer approval needed	- Frequency: 20 ~ 2000 Hz - Acceleration: 60 m/s^2 - Duration: 5 mins (each axis) - For vibration frequency, see Figure 7
Vibration Durability Test 3 - Sweep vibration	During/after test - No functional error After test - No visual error - To meet requirement - Bracket breakage * customer approval needed	- Frequency: 10 ~ 200 Hz - Sweep cycle: 15 min (log scale) - No. of sweep cycle: 300 (each axis) - Vibration direction: X, Y, Z - Acceleration for vibration: See Table 2
Vibration Durability Test 4 - Mixed condition	During/after test - No functional error After test - No visual error - To meet requirement	- Test duration: 20 hrs (each axis) - Test pattern: See Figure 8. - Temp. & operation condition: See Figure 9 - Vibration acceleration: 27.8 m/s^2
Thermal Shock Test	During/after test - No functional error After test - No solder/part error - To meet requirement	- Test 1 duration: 500 cycle (Indoor product) - Test 2 duration: 1000 cycle (engine room, exterior, etc) - Test pattern: See Fig.10
Impact Durability Test	After test - No functional error - To meet requirement	- Impact acceleration: 400 m/s^2 - Impact time: 11 ms - Number of impacts: See Table 3 - Check water immersion at 5V DC
High/Low Temperature Test (Product limit lifecycle test)	No criteria (Only functional error above/below operating temperature is acceptable)	- Place specimens at below temperature for 30 mins and then, operate for 30 mins [$^{\circ}\text{C}$] (-40, -30, +80, +90, +100, +110, +120, +130) - Check water immersion at 5V DC

Water Detection Sensor - Specifications

Materials

No.	Construction List	Material	Notes
1	Case	PBT	Black
2	Bush	C3604	
3	Terminal	C2680-1/2H	Pre-Tin, Cu/Sn
4	Resistor	510 k Ω	1/4 W
5	Resin	Epoxy	Black
6	Wire	AVSST, 0.3SQ	Black/Black
7	Label	15 X 15 mm	Laminated Coating

Dimensions

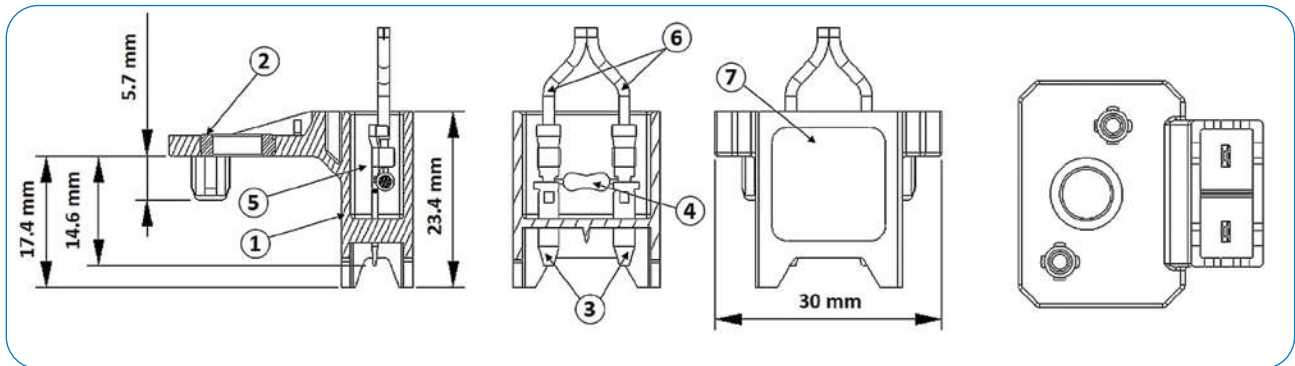

Notes:

1. Due to electrolysis of liquid and sensor, it is not suggested to use more than 1 hour in liquid.
2. The sensor must be replaced after warning signal to vehicle.
3. Do not disassemble or change any parts.
4. In use/stock of oil, may cause degradation of the sensor's characteristics.
5. Protect the sensor from flux/fume and high temperature during soldering.
6. Do not immerse sensor in liquid.

Water Detection Sensor - Specifications (Cont.)

Table.1 Resonance Durability Test

Resonance Frequency	Acceleration (m / s)	Vibration Frequency	Test Time		
			X-Axis	Y-Axis	Z-Axis
10-50 Hz	29.4	Resonance Frequency	3.00	1.50	1.50
50-100 Hz	9.8	Resonance Frequency	0.75	0.50	0.50
100-1000 Hz	4.9	Resonance Frequency	0.75	0.50	0.50
No Resonance Frequency	29.4	33	3.00	1.50	1.50

Table.2 Vibration Durability Test 3 – Sweep vibration

Frequency (Hz)	Direction (Acceleration)		
	X-Axis	Y-Axis	Z-Axis
10-30	34.3	36.3	22.5
30-50	14.7	15.7	10.8
50-80	5.88	6.86	4.31
80-200	2.65	2.84	1.86

Table.3 Impact Durability Test

Minimum 10-Year Warranty (Number of Impact per Axis)	Minimum 15-Year Warranty (Number of Impact per Axis)	Installation
72,000	100,000	Driver Seat Door
36,000	50,000	Passenger/Rear Seat Door
18,000	30,000	Trunk/Liftgate
2,000	3,000	Hood

Water Detection Sensor - Specifications

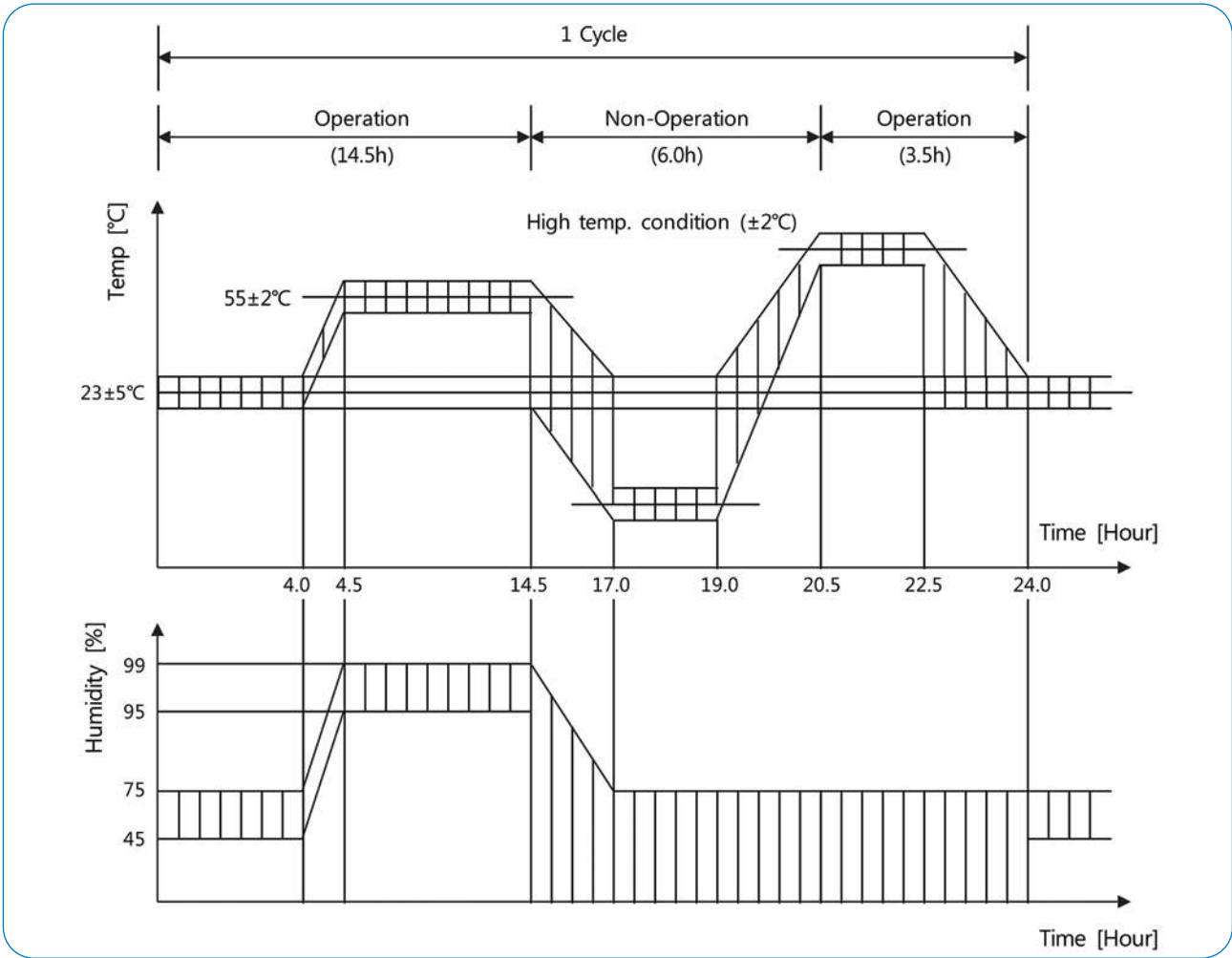

Figure 1: High Temperature/Humidity Cycle Test Graph (Power rated)

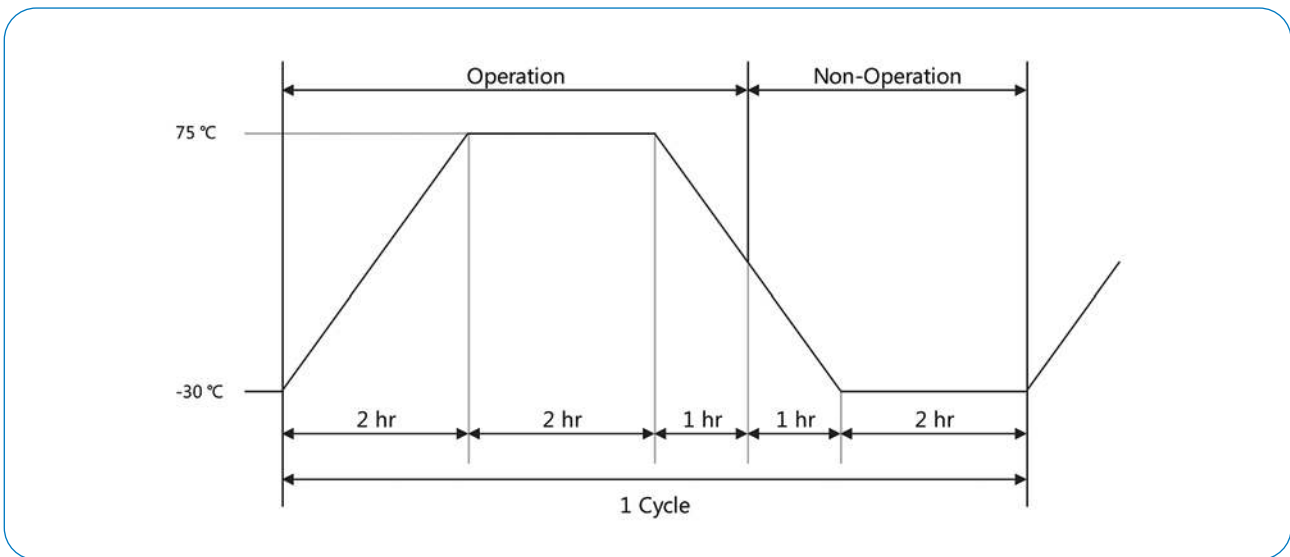

Figure 2: Temperature Cycle Test

Water Detection Sensor - Specifications (Cont.)

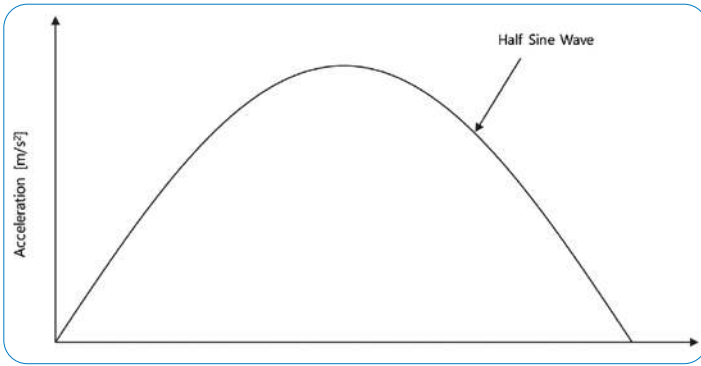

Figure 3: Impact Test

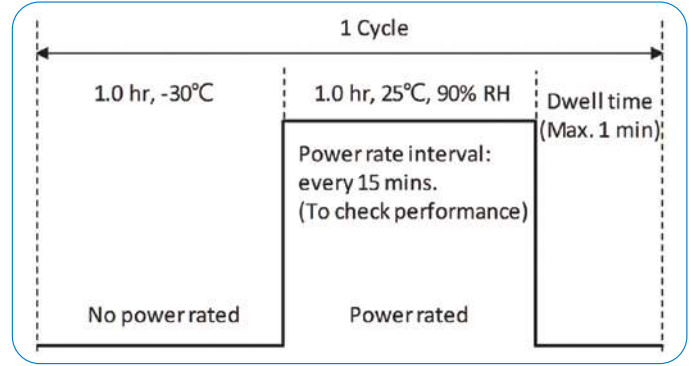

Figure 4: Dew Condensation Test

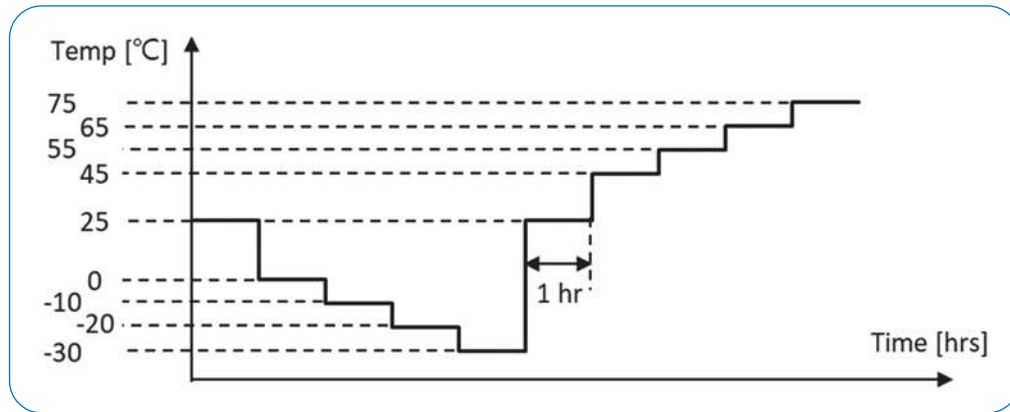

Figure 5: Temperature Characteristics Test

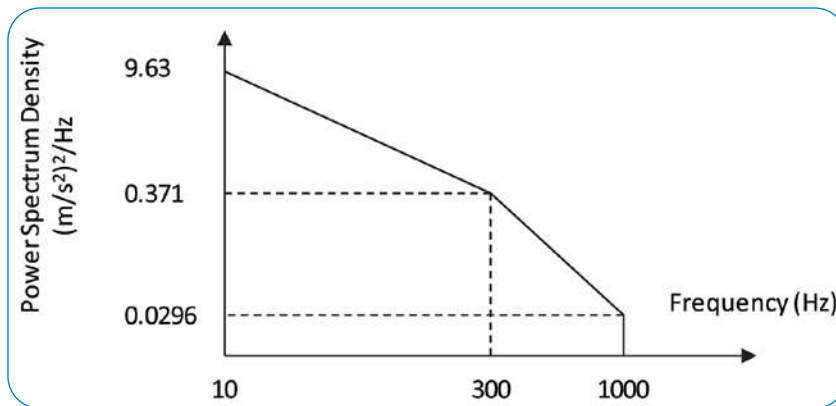

Figure 6: Vibration Durability Test 1 – Accelerated vibration (product)

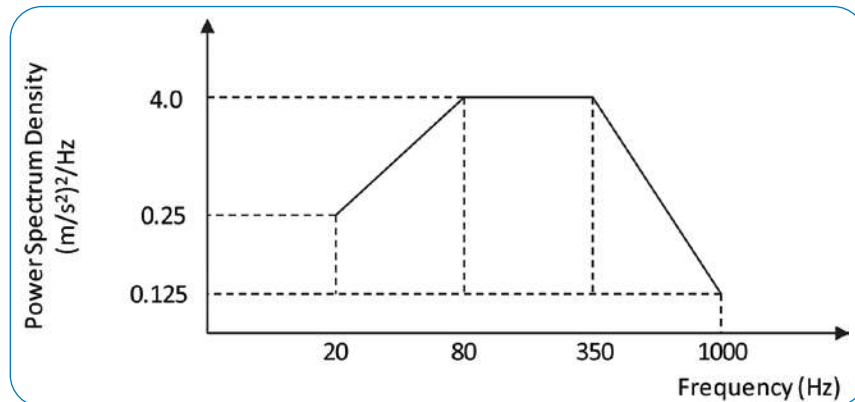

Figure 7: Vibration Durability Test 2 – Accelerated vibration (part)

Water Detection Sensor - Specifications (Cont.)

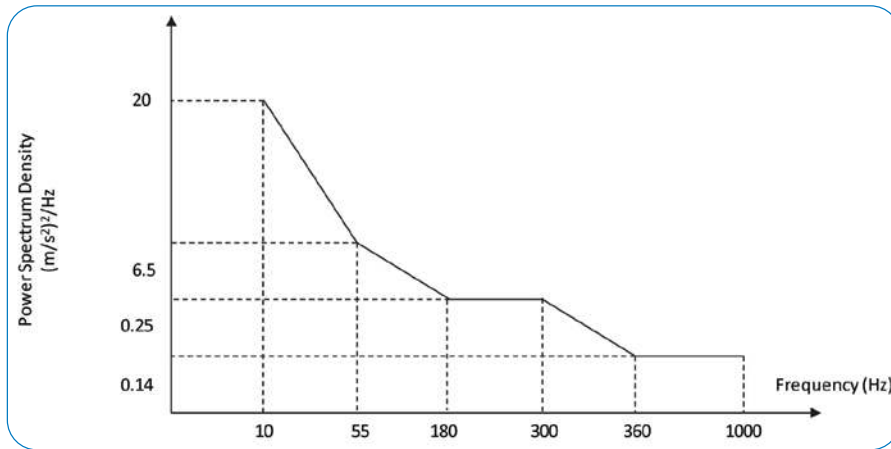

Figure 8: Vibration Durability Test 2 – Accelerated vibration (part)

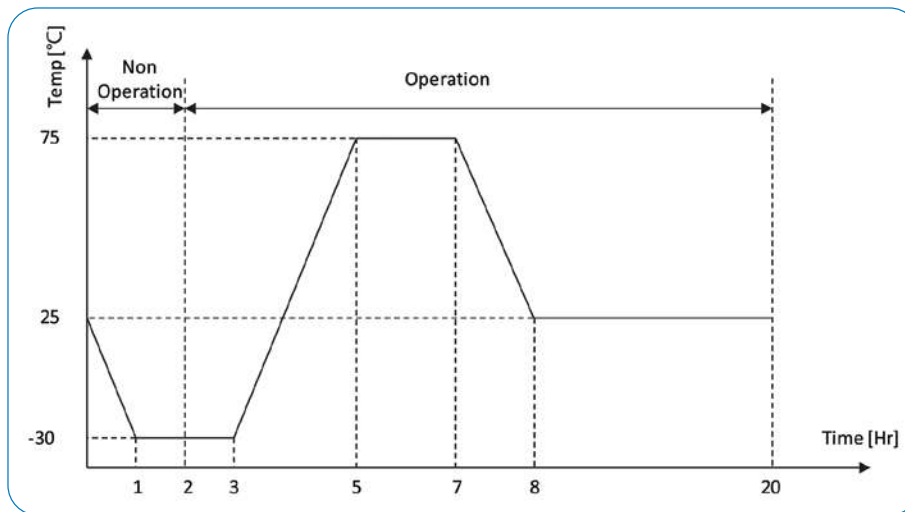

Figure 9: Vibration Durability Test 4 – Mixed condition

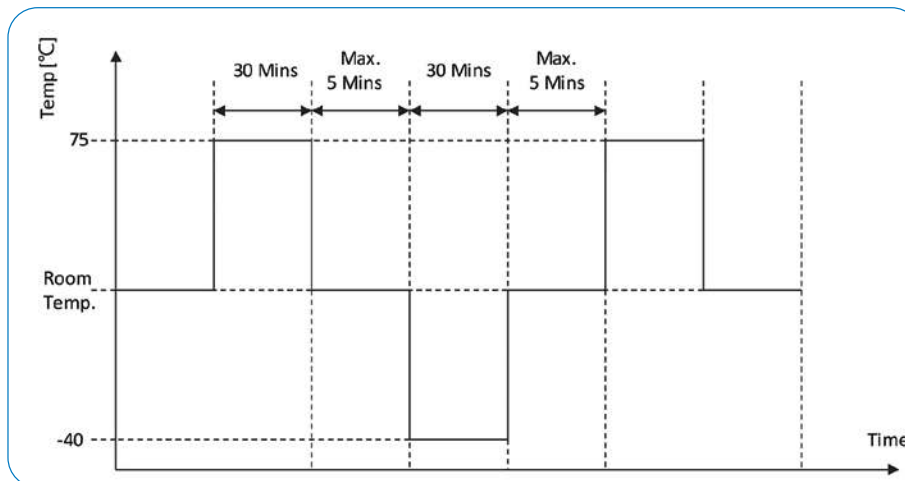

Figure 10: Thermal Shock Test