

### FEATURES

**Excellent  $TCV_{OS}$  Match,  $2 \mu V/^{\circ}C$  Max**  
**Low Input Offset Voltage,  $150 \mu V$  Max**  
**Low Supply Current,  $550 \mu A$  Max**  
**Single Supply Operation, 5 V to 30 V**  
**Low Input Offset Voltage Drift,  $0.75 \mu V/^{\circ}C$**   
**High Open-Loop Gain,  $1500 V/mV$  Min**  
**High PSRR,  $3 \mu V/V$**   
**Wide Common-Mode Voltage**  
**Range,  $V_-$  to within 1.5 V of  $V_+$**   
**Pin Compatible with 1458, LM158, LM2904**  
**Available in Die Form**

### PIN CONNECTIONS

8-Lead SOIC  
(S-Suffix)

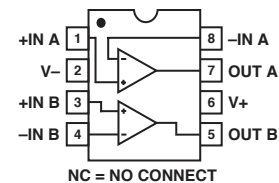

### GENERAL DESCRIPTION

The OP221 is a monolithic dual operational amplifier that can be used either in single or dual supply operation. The wide supply voltage range, wide input voltage range, and low supply current drain of the OP221 make it well-suited for operation from batteries or unregulated power supplies.

The excellent specifications of the individual amplifiers combined with the tight matching and temperature tracking between channels

provide high performance in instrumentation amplifier designs. The individual amplifiers feature very low input offset voltage, low offset voltage drift, low noise voltage, and low bias current. They are fully compensated and protected.

Matching between channels is provided on all critical parameters including input offset voltage, tracking of offset voltage vs. temperature, non-inverting bias currents, and common-mode rejection.

### SIMPLIFIED SCHEMATIC

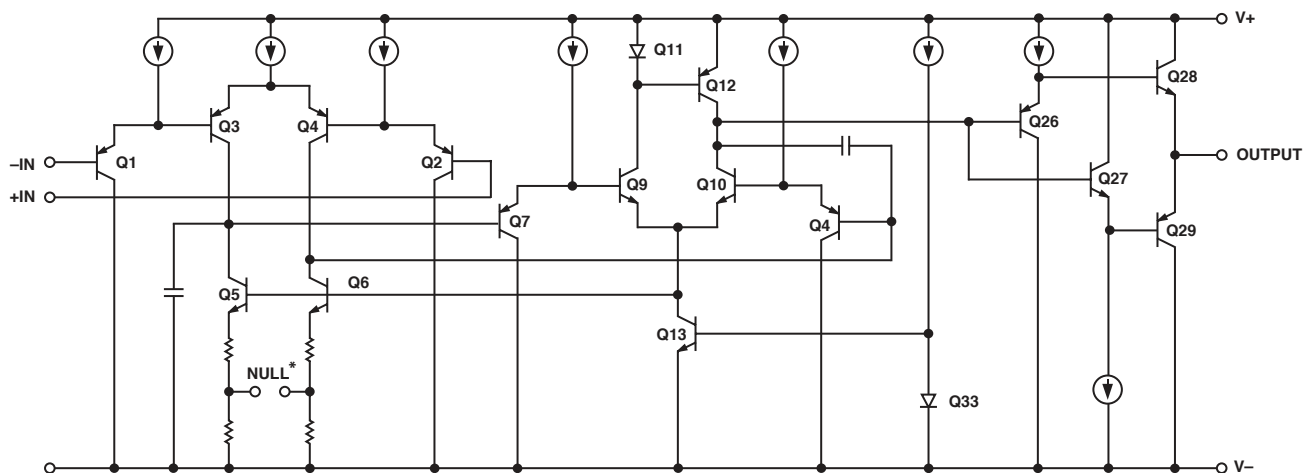

\*ACCESSIBLE IN CHIP FORM ONLY

### REV. C

Information furnished by Analog Devices is believed to be accurate and reliable. However, no responsibility is assumed by Analog Devices for its use, nor for any infringements of patents or other rights of third parties that may result from its use. No license is granted by implication or otherwise under any patent or patent rights of Analog Devices.

# OP221—SPECIFICATIONS (Electrical Characteristics at $V_S = \pm 2.5\text{ V}$ to $\pm 15\text{ V}$ , $T_A = 25^\circ\text{C}$ , unless otherwise noted.)

| OP221G                           |          |  |                   |          |            |                  |
|----------------------------------|----------|--|-------------------|----------|------------|------------------|
| Parameter                        | Symbol   | Conditions   | Min               | Typ      | Max        | Unit             |
| Input Offset Voltage             | $V_{OS}$ |  |                   | 250      | 500        | $\mu\text{V}$    |
| Input Offset Current             | $I_{OS}$ | $V_{CM} = 0$   |                   | 1.5      | 7          | nA               |
| Input Bias Current               | $I_B$    | $V_{CM} = 0$   |                   | 70       | 120        | nA               |
| Input Voltage Range              | IVR      | $V_+ = 5\text{ V}$ , $V_- = 0\text{ V}^1$<br>$V_S = \pm 15\text{ V}$   | 0/3.5<br>-15/13.5 |          |            | V                |
| Common-Mode Rejection Ratio      | CMRR     | $V_+ = -5\text{ V}$ , $V_- = 0\text{ V}$<br>$0\text{ V} \leq V_{CM} \leq 3.5\text{ V}$<br>$V_S = \pm 15\text{ V}$<br>$-15\text{ V} \leq V_{CM} \leq 13.5\text{ V}$ | 75                | 85       |            | dB               |
|                                  |          |  | 80                | 90       |            |                  |
| Power Supply Rejection Ratio     | PSRR     | $V_S = \pm 2.5\text{ V}$ to $\pm 15\text{ V}$<br>$V_- = 0\text{ V}$ , $V_+ = 5\text{ V}$ to $30\text{ V}$  |                   | 32<br>57 | 100<br>180 | $\mu\text{V/V}$  |
| Large-Signal Voltage Gain        | $A_{vo}$ | $V_S = \pm 15\text{ V}$ , $R_L = 10\text{ k}\Omega$<br>$V_O = \pm 10\text{ V}$   | 800               |          |            | V/mV             |
| Output Voltage Swing             | $V_O$    | $V_+ = 5\text{ V}$ , $V_- = 0\text{ V}$<br>$R_L = 10\text{ k}\Omega$<br>$V_S = 15\text{ V}$ , $R_L = 10\text{ k}\Omega$  | 0.8/4             |          |            | V                |
|                                  |          |  | $\pm 13.5$        |          |            |                  |
| Slew Rate                        | SR       | $R_L = 10\text{ k}\Omega^2$  | 0.2               | 0.3      |            | V/ $\mu\text{s}$ |
| Bandwidth                        | BW       |  |                   | 600      |            | kHz              |
| Supply Current (Both Amplifiers) | $I_{SY}$ | $V_S = \pm 2.5\text{ V}$ , No Load<br>$V_S = \pm 15\text{ V}$ , No Load  |                   | 550      | 650        | $\mu\text{A}$    |
|                                  |          |  |                   | 850      | 900        |                  |

# SPECIFICATIONS

(Electrical Characteristics at  $V_S = \pm 2.5 \text{ V}$  to  $\pm 15 \text{ V}$ ,  $-40^\circ\text{C} \leq T_A \leq +85^\circ\text{C}$ , unless otherwise noted.)

| OP221G  |            |   |                   |            |             |                              |
|---|------------|---|-------------------|------------|-------------|------------------------------|
| Parameter                                       | Symbol     | Conditions  | Min               | Typ        | Max         | Unit                         |
| Average Input Offset Voltage Drift <sup>1</sup> | $TCV_{OS}$ |   |                   | 2          | 3           | $\mu\text{V}/^\circ\text{C}$ |
| Input Offset Voltage                            | $V_{OS}$   |   |                   | 400        | 700         | $\mu\text{V}$                |
| Input Offset Current                            | $I_{OS}$   | $V_{CM} = 0$  |                   | 2          | 10          | nA                           |
| Input Bias Current                              | $I_B$      | $V_{CM} = 0$  |                   | 80         | 140         | nA                           |
| Input Voltage Range                             | IVR        | $V_+ = 5 \text{ V}$ , $V_- = 0 \text{ V}^2$<br>$V_S = \pm 15 \text{ V}$   | 0/3.2<br>-15/13.2 |            |             | V                            |
| Common-Mode Rejection Ratio                     | CMRR       | $V_+ = -5 \text{ V}$ , $V_- = 0 \text{ V}$<br>$0 \text{ V} \leq V_{CM} \leq 3.5 \text{ V}$<br>$V_S = \pm 15 \text{ V}$<br>$-15 \text{ V} \leq V_{CM} \leq 13.5 \text{ V}$ | 70<br>75          | 80<br>85   |             | dB                           |
| Power Supply Rejection Ratio                    | PSRR       | $V_S = \pm 2.5 \text{ V}$ to $\pm 15 \text{ V}$<br>$V_- = 0 \text{ V}$ , $V_+ = 5 \text{ V}$ to $30 \text{ V}$  |                   | 57<br>100  | 180<br>320  | $\mu\text{V}/\text{V}$       |
| Large-Signal Voltage Gain                       | $A_{VO}$   | $V_S = \pm 15 \text{ V}$ , $R_L = 10 \text{ k}\Omega$<br>$V_O = \pm 10 \text{ V}$   | 600               |            |             | V/mV                         |
| Output Voltage Swing                            | $V_O$      | $V_+ = 5 \text{ V}$ , $V_- = 0 \text{ V}$<br>$R_L = 10 \text{ k}\Omega$<br>$V_S = 15 \text{ V}$ , $R_L = 10 \text{ k}\Omega$  | 0.9/3.7<br>13.2   |            |             | V                            |
| Supply Current (Both Amplifiers)                | $I_{SY}$   | $V_S = \pm 2.5 \text{ V}$ , No Load<br>$V_S = \pm 15 \text{ V}$ , No Load   |                   | 600<br>950 | 750<br>1000 | $\mu\text{A}$                |

## NOTES

<sup>1</sup>Sample tested.<sup>2</sup>Guaranteed by CMRR test limits.

## Matching Characteristics at $V_S = \pm 15 \text{ V}$ , $T_A = 25^\circ\text{C}$ , unless otherwise noted.

| OP221G  |                     |   |     |     |     |                        |
|---|---------------------|---|-----|-----|-----|------------------------|
| Parameter                                       | Symbol              | Conditions                                      | Min | Typ | Max | Unit                   |
| Input Offset Voltage Match                      | $\Delta V_{OS}$     |   |     | 250 | 600 | $\mu\text{V}$          |
| Average Noninverting Bias Current               | $I_{B+}$            |   |     |     | 120 | nA                     |
| Noninverting Input Offset Current               | $I_{OS+}$           |   |     | 4   | 10  | nA                     |
| Common-Mode Rejection Ratio Match <sup>1</sup>  | $\Delta\text{CMRR}$ | $V_{CM} = -15 \text{ V}$ to $13.5 \text{ V}$    | 72  |     |     | dB                     |
| Power Supply Rejection Ratio Match <sup>2</sup> | $\Delta\text{PSRR}$ | $V_S = \pm 2.5 \text{ V}$ to $\pm 15 \text{ V}$ |     |     | 140 | $\mu\text{V}/\text{V}$ |

## NOTES

<sup>1</sup> $\Delta\text{CMRR}$  is  $20 \log_{10} V_{CM}/\Delta\text{CME}$ , where  $V_{CM}$  is the voltage applied to both noninverting inputs and  $\Delta\text{CME}$  is the difference in common-mode input-referred error.<sup>2</sup> $\Delta\text{PSRR}$  is:  $\frac{\text{Input-Referred Differential Error}}{\Delta V_S}$

# OP221—SPECIFICATIONS (Matching Characteristics at $V_s = \pm 15\text{ V}$ , $-40^\circ\text{C} \leq T_A \leq +85^\circ\text{C}$ for OP221G, unless otherwise noted. G is sample tested.)

| OP221G  |                     |   |     |     |     |                             |
|---|---------------------|---|-----|-----|-----|-----------------------------|
| Parameter                                       | Symbol              | Conditions                                | Min | Typ | Max | Unit                        |
| Input Offset Voltage Match                      | $\Delta V_{OS}$     |   |     | 400 | 800 | $\mu\text{V}$               |
| Average Noninverting Bias Current               | $I_{B+}$            | $V_{CM} = 0$                              |     |     | 140 | nA                          |
| Input Offset Voltage Tracking                   | $IC\Delta V_{OS}$   |   |     | 3   | 5   | $\mu\text{V}^\circ\text{C}$ |
| Noninverting Input Offset Current               | $I_{OS+}$           | $V_{CM} = 0$                              |     | 6   | 12  | nA                          |
| Common-Mode Rejection Ratio Match <sup>1</sup>  | $\Delta\text{CMRR}$ | $V_{CM} = -15\text{ V to } 13.2\text{ V}$ | 72  | 80  |     | dB                          |
| Power Supply Rejection Ratio Match <sup>2</sup> | $\Delta\text{PSRR}$ |   |     | 140 |     | $\mu\text{V}/\text{V}$      |

NOTES

<sup>1</sup> $\Delta\text{CMRR}$  is  $20 \log_{10} V_{CM}/\Delta\text{CME}$ , where  $V_{CM}$  is the voltage applied to both noninverting inputs and  $\Delta\text{CME}$  is the difference in common-mode input-referred error.

<sup>2</sup> $\Delta\text{PSRR}$  is:  $\frac{\text{Input-Referred Differential Error}}{\Delta V_s}$

# OP221

**ABSOLUTE MAXIMUM RATINGS (Note 1)**

Supply Voltage . . . . . ±18 V  
 Differential Input Voltage . . . . . 30 V or Supply Voltage  
 Input Voltage . . . . . Supply Voltage  
 Output Short-Circuit Duration . . . . . Indefinite  
 Storage Temperature Range . . . . . -65°C to +150°C  
 Operating Temperature Range  
 OP221G . . . . . -40°C to +85°C  
 Lead Temperature (Soldering 60 sec) . . . . . 300°C  
 Junction Temperature (T<sub>J</sub>) . . . . . -65°C to +150°C

| Package Type   | θ <sub>JA</sub> (Note 2) | θ <sub>JC</sub> | Unit |
|----------------|--------------------------|-----------------|------|
| 8-Lead SOIC(S) | 158                      | 43              | °C/W |

NOTES  
<sup>1</sup>Absolute maximum ratings apply to both DICE and packaged parts, unless otherwise noted.  
<sup>2</sup>θ<sub>JA</sub> is specified for device soldered to printed circuit board for SOIC package.

**ORDERING GUIDE**

| T <sub>A</sub> = +25°C<br>V <sub>OS</sub> MAX<br>(μV) | Plastic<br>8-Lead | Operating<br>Temperature<br>Range | Package<br>Options |
|---|-------------------|-----------------------------------|--------------------|
| 150   |                   |                                   |                    |
| 150   |                   |                                   |                    |
| 300   |                   |                                   |                    |
| 500   |                   |                                   |                    |
| 500   |                   |                                   |                    |
| 500   | OP221GS           | XIND                              | RN-8               |

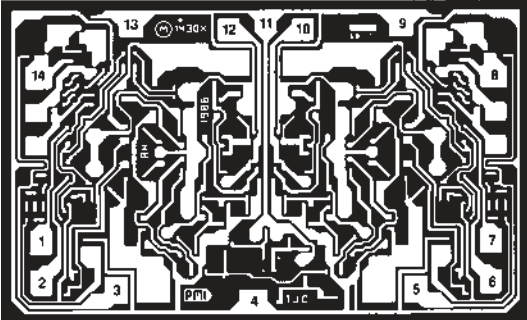

- 1. INVERTING INPUT (A)
- 2. NONINVERTING INPUT (A)
- 3. BALANCE (A)
- 4. V-
- 5. BALANCE (B)
- 6. INVERTING INPUT (B)
- 7. NONINVERTING INPUT (B)
- 8. BALANCE (B)
- 9. V+
- 10. OUT (B)
- 11. V+
- 12. OUT (A)
- 13. V+
- 14. BALANCE (A)

DIE SIZE 0.097 X 0.063 INCH, 6111 SQ. MILS  
 (2.464 X 1.600 MM, 3.94 SQ. MM)

NOTE: ALL V+ PADS ARE INTERNALLY CONNECTED.

Figure 1. Dice Characteristics

**CAUTION**

ESD (electrostatic discharge) sensitive device. Electrostatic charges as high as 4000 V readily accumulate on the human body and test equipment and can discharge without detection. Although the OP221 features proprietary ESD protection circuitry, permanent damage may occur on devices subjected to high-energy electrostatic discharges. Therefore, proper ESD precautions are recommended to avoid performance degradation or loss of functionality.



# OP221–Typical Performance Characteristics

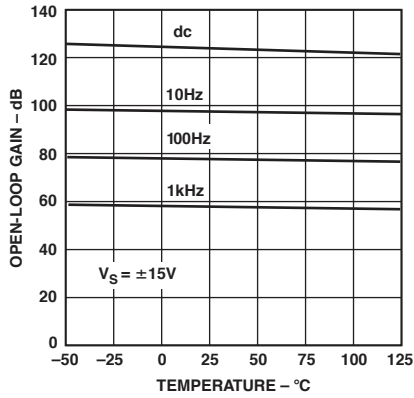

TPC 1. Open-Loop Gain at  $\pm 15$  V vs. Temperature

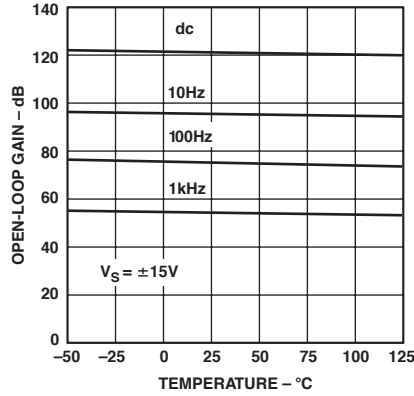

TPC 2. Open-Loop Gain at  $\pm 5$  V vs. Temperature

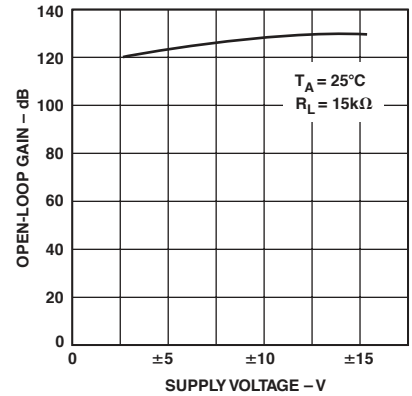

TPC 3. Open-Loop Gain at vs. Supply Voltage

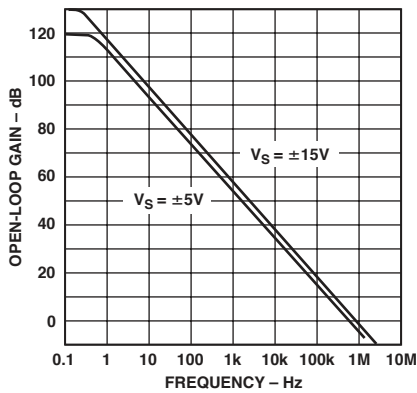

TPC 4. Open-Loop Gain at  $\pm 15$  V vs. Frequency

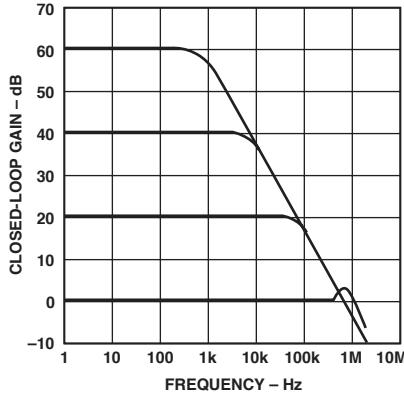

TPC 5. Closed-Loop Gain vs. Frequency

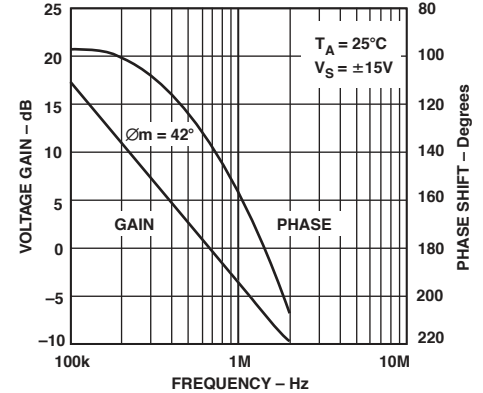

TPC 6. Gain and Phase Shift vs. Frequency

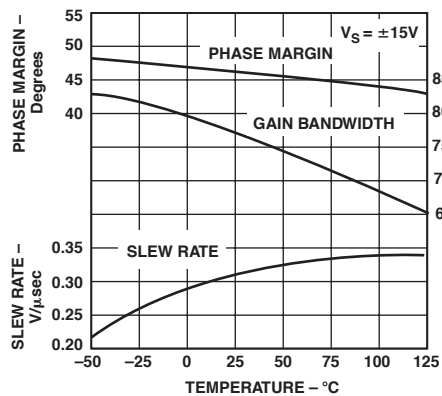

TPC 7. Phase Margin, Gain Bandwidth, and Slew Rate vs. Temperature

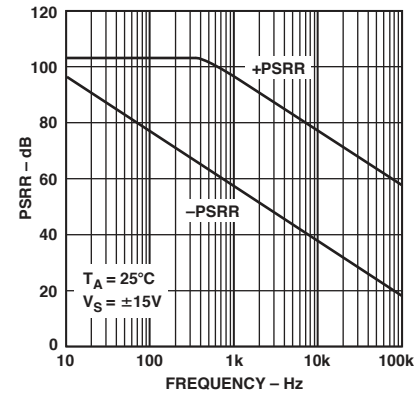

TPC 8. PSRR vs. Frequency

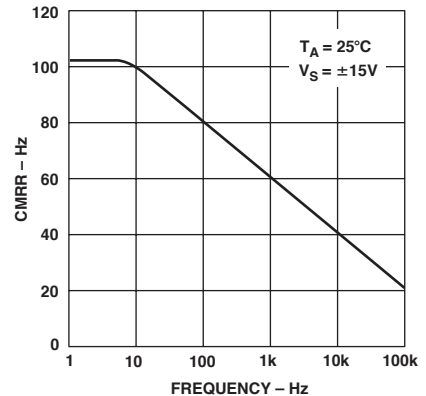

TPC 9. CMRR vs. Frequency

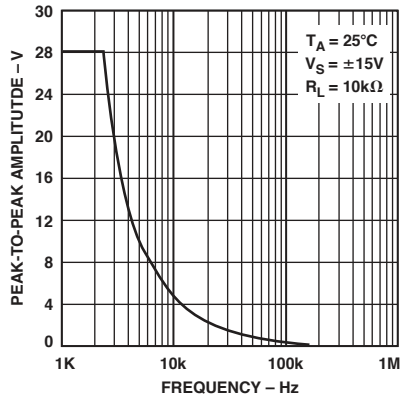

TPC 10. Maximum Output Swing vs. Frequency

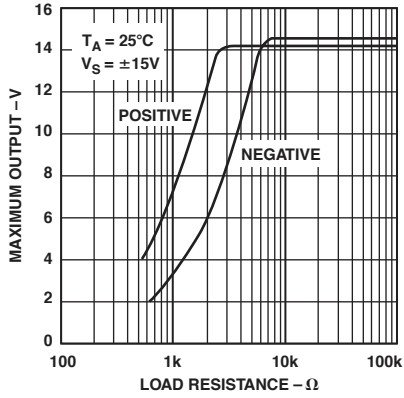

TPC 11. Maximum Output Voltage vs. Load Resistance

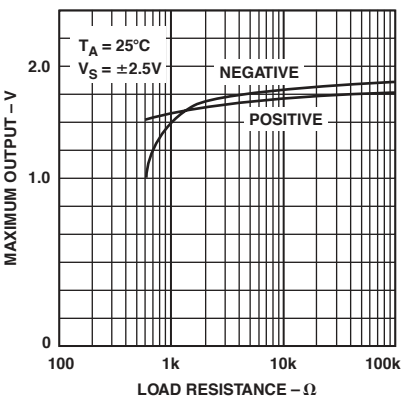

TPC 12. Maximum Output Voltage vs. Load Resistance

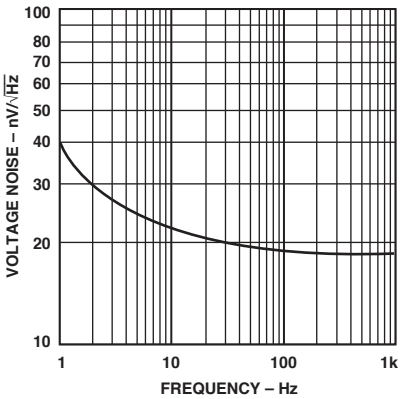

TPC 13. Voltage Noise Density vs. Frequency

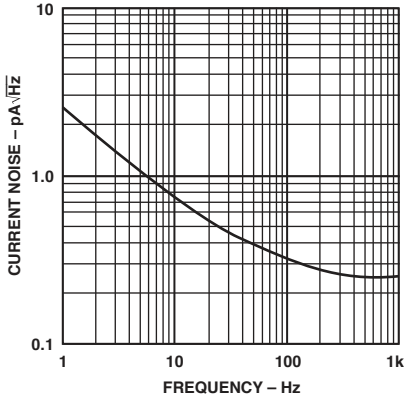

TPC 13. Current Noise Density vs. Frequency

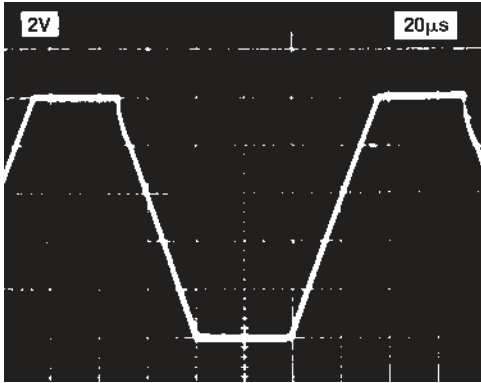

Figure 2a. Noninverting Step Response

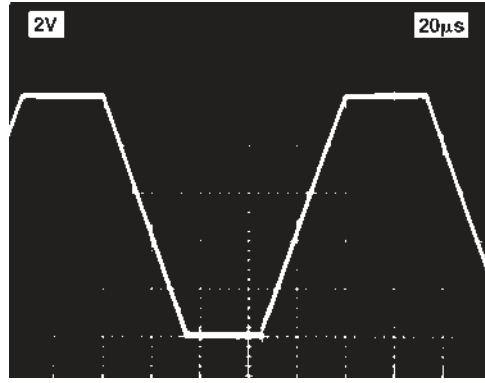

Figure 3a. Inverting Step Response

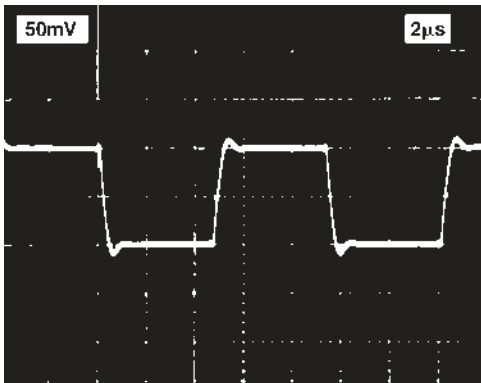

Figure 2b. Noninverting Step Response

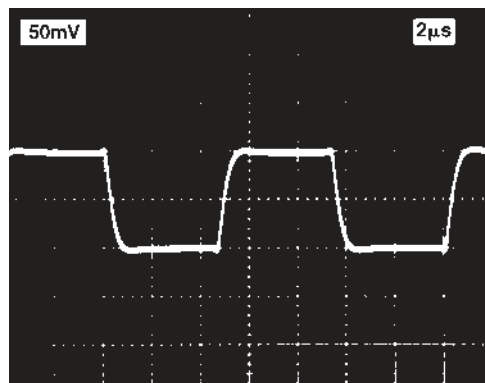

Figure 3b. Inverting Step Response

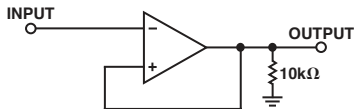

Figure 4. Noninverting Test Circuit

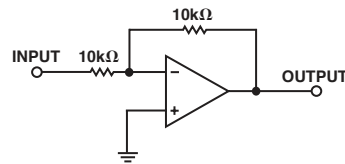

Figure 5. Inverting Test Circuit



**SPECIAL NOTES ON THE APPLICATION OF DUAL MATCHED OPERATIONAL AMPLIFIERS**

**Advantages of Dual Monolithic Operational Amplifiers**

Dual matched operational amplifiers provide the engineer with a powerful tool for designing instrumentation amplifiers and many other differential-input circuits. These designs are based on the principle that careful matching between two operational amplifiers can minimize the effect of dc errors in the individual amplifiers.

Reference to the circuit shown in Figure 6, a differential-in, differential-out amplifier, shows how the reductions in error can be accomplished. Assuming the resistors used are ideally matched, the gain of each side will be identical. If the offset voltages of each amplifier are perfectly matched, then the net differential voltage at the amplifier's output will be zero. Note that the output offset error of this amplifier is not a function of the offset voltage of the individual amplifiers, but only a function of the difference (degree of matching) between the amplifiers' offset voltages. This error-cancellation principle holds for a considerable number of input referred error parameters—offset voltage, offset voltage drift, inverting and noninverting bias currents, common mode and power supply rejection ratios. Note also that the impedances of each input, both common-mode and differential-mode, are high and tightly matched, an important feature not practical with single operation amplifier circuits.

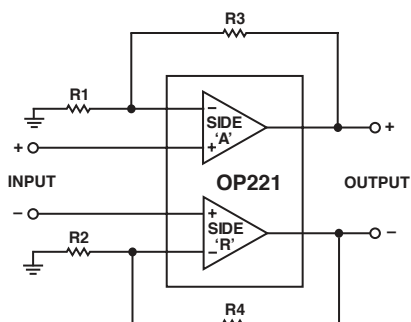

Figure 6. Differential-In, Differential-Out Amplifier

**INSTRUMENTATION AMPLIFIER APPLICATIONS**

**Two-Op Amp Configuration**

The two-op amp circuit (Figure 7) is recommended where the common-mode input voltage range is relatively limited; the common-mode and differential voltage both appear at V1. The high open-loop gain of the OP221 is very important in achieving good CMRR in this configuration. Finite open-loop gain of A1 (A<sub>o1</sub>) causes undesired feedthrough of the common-mode input. For A<sub>d</sub>/A<sub>o</sub> << 1, the common-mode error (CME) at the output due to this effect is approximately (2 A<sub>d</sub>/A<sub>o1</sub>) x V<sub>CM</sub>. This circuit features independent adjustment of CMRR and differential gain.

**Three-Op Amp Configuration**

The three-op amp circuit (Figure 8) has increased common-mode voltage range because the common-mode voltage is not amplified as it is in Figure 7. The CMR of this amplifier is directly proportional to the match of the CMR of the input op amps. CMRR can be raised even further by trimming the output stage resistors.

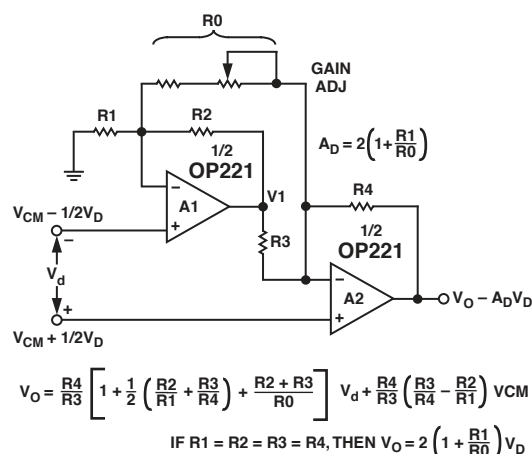

Figure 7. Two-Op Amp Circuit

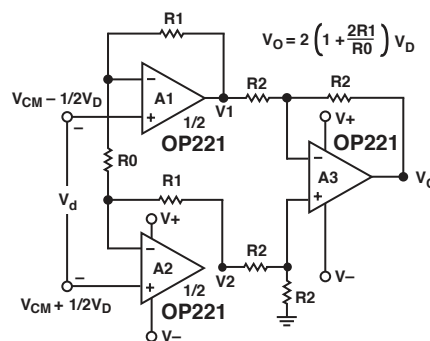
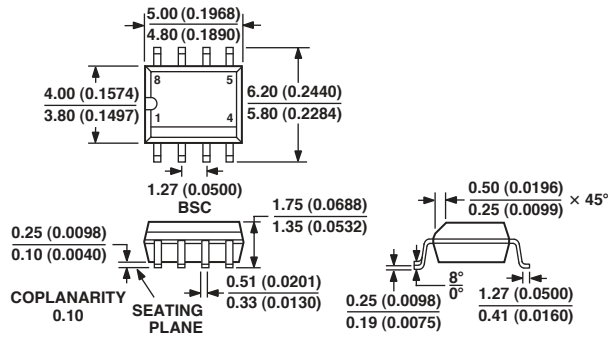

Figure 8. Three-Op Amp Circuit

OUTLINE DIMENSIONS

8-Lead Standard Small Outline Package [SOIC]  
Narrow Body  
(RN-8)

Dimensions shown in millimeters and (inches)



COMPLIANT TO JEDEC STANDARDS MS-012AA  
CONTROLLING DIMENSIONS ARE IN MILLIMETERS; INCH DIMENSIONS  
(IN PARENTHESES) ARE ROUNDED-OFF MILLIMETER EQUIVALENTS FOR  
REFERENCE ONLY AND ARE NOT APPROPRIATE FOR USE IN DESIGN

## Revision History

| Location   | Page      |
|--|-----------|
| <b>10/02—Data Sheet changed from REV. B to REV. C.</b>       |           |
| Deleted 8-Lead CERDIP Package (Q-8) . . . . .                | Universal |
| Edits to SPECIFICATIONS . . . . .                            | 2–4       |
| Edits to ABSOLUTE MAXIMUM RATINGS . . . . .                  | 5         |
| Edits to ORDERING GUIDE . . . . .                            | 5         |
| Updated OUTLINE DIMENSIONS . . . . .                         | 10        |
| <b>6/02—Data Sheet changed from REV. A to REV. B.</b>        |           |
| Edits to 8-Lead SOIC Package (R-8) . . . . .                 | 10        |
| <b>09/01—Data Sheet changed from REV. 0 to REV. A.</b>       |           |
| Edits to PIN CONNECTIONS . . . . .                           | 1         |
| Global deletion of references to OP221B and OP221C . . . . . | 2, 3, 4   |
| Edits to WAFER TEST LIMITS . . . . .                         | 4         |
| Edits to ABSOLUTE MAXIMUM RATINGS . . . . .                  | 5         |
| Edits to ORDERING GUIDE . . . . .                            | 5         |
| Edits to PACKAGE TYPE . . . . .                              | 5         |

