

TE Internal #: 4-2338495-3

OSFP, Cage Assembly, Cable-to-Board, 1 x 4, Through Hole - Press-Fit Mount, Printed Circuit Board, Included Lightpipe, Internal /External EMI Springs

[View on TE.com >](#)



Connectors > Pluggable IO Connectors & Cages > OSFP > OSFP Cage Assembly: EMI Springs



Pluggable I/O Product Type: **Cage Assembly**

Connector System: **Cable-to-Board**

Port Matrix Configuration: **1 x 4**

PCB Mounting Style: **Through Hole - Press-Fit**

Sealable: **No**

[All OSFP Cage Assembly: EMI Springs \(11\)](#)

Features

Product Type Features

Form Factor	OSFP
Cage Type	Ganged
Pluggable I/O Product Type	Cage Assembly
Connector System	Cable-to-Board
Sealable	No
Connector & Contact Terminates To	Printed Circuit Board

Configuration Features

Port Matrix Configuration	1 x 4
---------------------------	-------

Mechanical Attachment

PCB Mounting Style	Through Hole - Press-Fit
--------------------	--------------------------

Usage Conditions

Operating Temperature Range	-55 – 85 °C[-67 – 185 °F]
-----------------------------	---------------------------

Other



Included Lightpipe	Yes
EMI Containment Feature Type	Internal/External EMI Springs

Product Compliance

[For compliance documentation, visit the product page on TE.com>](#)

EU RoHS Directive 2011/65/EU	Compliant
EU ELV Directive 2000/53/EC	Compliant
China RoHS 2 Directive MIIT Order No 32, 2016	No Restricted Materials Above Threshold
EU REACH Regulation (EC) No. 1907/2006	Current ECHA Candidate List: JUNE 2023 (235) Candidate List Declared Against: JAN 2021 (211) Does not contain REACH SVHC
Halogen Content	Not Low Halogen - contains Br or Cl > 900 ppm.
Solder Process Capability	Not applicable for solder process capability

Product Compliance Disclaimer

This information is provided based on reasonable inquiry of our suppliers and represents our current actual knowledge based on the information they provided. This information is subject to change. The part numbers that TE has identified as EU RoHS compliant have a maximum concentration of 0.1% by weight in homogenous materials for lead, hexavalent chromium, mercury, PBB, PBDE, DBP, BBP, DEHP, DIBP, and 0.01% for cadmium, or qualify for an exemption to these limits as defined in the Annexes of Directive 2011/65/EU (RoHS2). Finished electrical and electronic equipment products will be CE marked as required by Directive 2011/65/EU. Components may not be CE marked. Additionally, the part numbers that TE has identified as EU ELV compliant have a maximum concentration of 0.1% by weight in homogenous materials for lead, hexavalent chromium, and mercury, and 0.01% for cadmium, or qualify for an exemption to these limits as defined in the Annexes of Directive 2000/53/EC (ELV). Regarding the REACH Regulation, the information TE provides on SVHC in articles for this part number is based on the latest European Chemicals Agency (ECHA) 'Guidance on requirements for substances in articles' posted at this URL: <https://echa.europa.eu/guidance-documents/guidance-on-reach>

Compatible Parts



Customers Also Bought

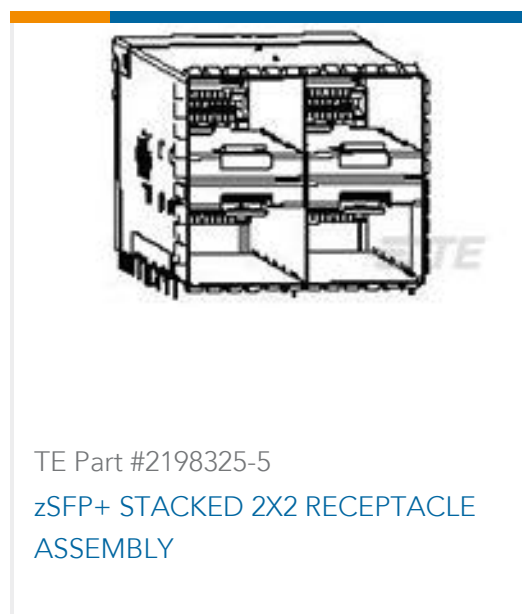

Documents

Product Drawings

CAGE ASSEMBLY, 4 LP PER PORT, 1X4, OSFP

English

CAD Files

3D PDF

3D

Customer View Model

[ENG_CVM_CVM_4-2338495-3_B.2d_dxf.zip](#)

English

Customer View Model

[ENG_CVM_CVM_4-2338495-3_B.3d_igs.zip](#)

English

Customer View Model

[ENG_CVM_CVM_4-2338495-3_B.3d_stp.zip](#)

English

By downloading the CAD file I accept and agree to the [Terms and Conditions](#) of use.

Datasheets & Catalog Pages

OSFP Cages, Connectors, and Cable Assemblies (English)

English

Product Environmental Compliance

Product Compliance

English

Product Compliance

English

4-2338495-3

OSFP, Cage Assembly, Cable-to-Board, 1 x 4, Through Hole - Press-Fit Mount,
Printed Circuit Board, Included Lightpipe, Internal/External EMI Springs

