

Metal Oxide Varistor High Surge Type, 5~20mm

MVR-S Series

MERITEK

FEATURE

- Operating / Storage Temperature: -40°C ~ +105°C / -40°C +125°C
- Varistor Voltage: 18V to 1800V
- Withstanding Surge Current Rating Up to 10KA
- Various Lead Form and Spacing Options
- UL/cUL Safety Approved: Certification No: E326004
- VDE Safety Approved: Certification No: 40013638



PART NUMBERING SYSTEM

MVR **14** **D** **911** **K** **O** - **S**
(1) (2) (3) (4) (5) (6) (7)



No	Item	Digit	Description	Series Reference
(1)	Meritek Series	MVR	Metal Oxide Varistor	Leaded Type
(2)	Diameter	14	14: φ14mm	5, 7, 10, 14, 20mm
(3)	Lead/Package Type	D	D: Round Disk or Dual Square Disk	S: Single Square, A: Bare
(4)	Voltage	911	911: 910VDC	18V~1800V
(5)	Tolerance	K	K: ±10%	-10% ~ +10%
(6)	Lead Type	O	O: Out kink	Blank: Straight, Y: Y Kink,
(7)	Surge Type	S	-S: High Surge	Blank: Standard Surge type

ELECTRICAL CHARACTERISTICS AND DIMENSIONS REFERENCE TABLE

MVR-S Series	Varistor DC Voltage @1mA	Maximum Energy (10/1Kμs)	D	H	H1	L min	L1 min	d ± 0.05	d1 ± 0.4	F
MVR05D-S	18V~750V	0.6J~32J	5.0~7.5	5.5~10.0	8.0~13.0	20.0	15.0	0.6	1.2	5.0±0.8
MVR07D-S	18V~820V	3.0J~70J	7.0~9.0	7.5~12.0	9.0~13.5	20.0	15.0	0.6	1.2	5.0±0.8
MVR10D-S	18V~1.1KV	3.0J~155J	10.0~12.5	10.5~16.0	13.0~17.5	20.0	15.0	0.8	1.4	7.5±0.8
MVR14D-S	18V~1.8KV	7.0J~335J	14.0~16.5	14.5~20.0	17.0~21.0	20.0	15.0	0.8	1.4	7.5±0.8
MVR20D-S	18V~1.8KV	13J~990J	20.0~23.0	21.0~26.0	24.0~28.0	20.0	15.0	0.8	1.4	7.5±0.8
								1.0	1.6	10.0±1.0

(Unit: mm)

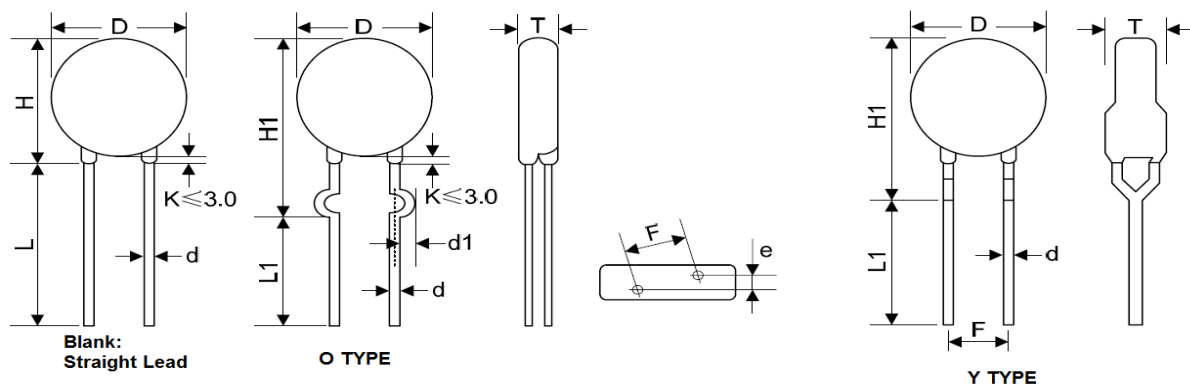

Metal Oxide Varistor High Surge Type, 5~20mm

MVR-S Series

MERITEK

ELECTRICAL CHARACTERISTICS – MOV05D-S SERIES

[Back to Top](#)

MVR05D-S Series	Varistor DC Voltage @1mA		Max. Allowable Voltage		Max. Clamping Voltage		Withstanding Surge Current (A)	Max. Energy (10/1K μ s) (J)	Rated Power (W)	Typical Cap. @1KHz (pF)	Dimension	
	V _{DC}	V _{ACrms}	V _{DC}	V _c	I _p	T max					e ±0.8	
	(V)	(V)	(V)	(V)	(A)							
MVR05D180K-S	18(15~21.6)	11	14	40	1	250	0.01	0.6	0.01	1,400	4.5	1.3
MVR05D220K-S	22(19.5~26)	14	18	48				0.7		1,150	4.6	1.4
MVR05D270K-S	27(24~31)	17	22	60				0.9		930	4.7	1.6
MVR05D330K-S	33(29.5~36.5)	20	26	73				1.1		760	4.9	1.5
MVR05D390K-S	39(35~43)	25	31	80				1.2		640	4.8	1.6
MVR05D470K-S	47(42~52)	30	38	104				1.5		530	4.9	1.7
MVR05D560K-S	56(50~62)	35	45	123				1.8		450	5.0	1.9
MVR05D680K-S	68(61~75)	40	56	145				2.2		370	5.2	2.2
MVR05D820K-S	82(74~90)	50	65	150	5	800	0.10	4.0	0.10	300	4.1	1.6
MVR05D101K-S	100(90~110)	60	85	177				4.1		250	4.3	1.8
MVR05D121K-S	120(108~132)	75	100	210				4.9		210	4.5	2.0
MVR05D151K-S	150(135~165)	95	125	260				6.5		165	4.8	1.6
MVR05D181K-S	180(162~198)	115	150	320				7.5		140	4.3	1.7
MVR05D201K-S	200(180~220)	130	170	355				8.5		125	4.4	1.8
MVR05D221K-S	220(198~242)	140	180	380				9.0		110	4.5	1.9
MVR05D241K-S	240(216~264)	150	200	415				10.5		100	4.6	2.0
MVR05D271K-S	270(243~297)	175	225	475				11.0		95	4.9	2.2
MVR05D301K-S	300(270~330)	190	250	520				12.0		85	5.0	2.3
MVR05D331K-S	330(297~363)	210	275	570				13.0		75	5.1	2.3
MVR05D361K-S	360(324~396)	230	300	620				16.0		70	5.2	2.5
MVR05D391K-S	390(351~429)	250	320	675				17.0		65	5.4	2.6
MVR05D431K-S	430(387~473)	275	350	745				20.0		60	5.7	2.8
MVR05D471K-S	470(423~517)	300	385	810				21.0		55	6.0	3.0
MVR05D511K-S	510(459~561)	320	415	845				22.5		50	6.2	4.0
MVR05D561K-S	560(504~616)	350	460	920				24.0		45	6.5	3.4
MVR05D621K-S	620(558~682)	385	505	1025				25.0		40	6.5	3.7
MVR05D681K-S	680(612~748)	420	560	1120	29.0	35	6.8	4.0				
MVR05D751K-S	750(675~825)	460	615	1240	32.0	30	6.9	4.1				

Notes:

- The tolerance of varistor voltage between 18V and 27V is more than 10%.
- Leakage Current (@83% of V_{1mA}) : IR≤50 μ A (180K~680K) IR≤25 μ A (820K~751K)

Metal Oxide Varistor High Surge Type, 5~20mm

MVR-S Series

MERITEK

SURGE CURRENT DERATING CURVES – MVR05D-S SERIES

[Back to Top](#)

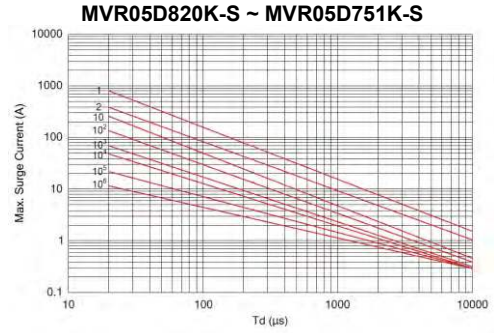
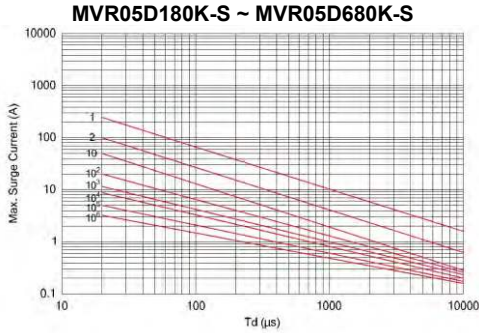

LEAKAGE CURRENT & CLAMPING VOLTAGE CURVES – MVR05D-S SERIES

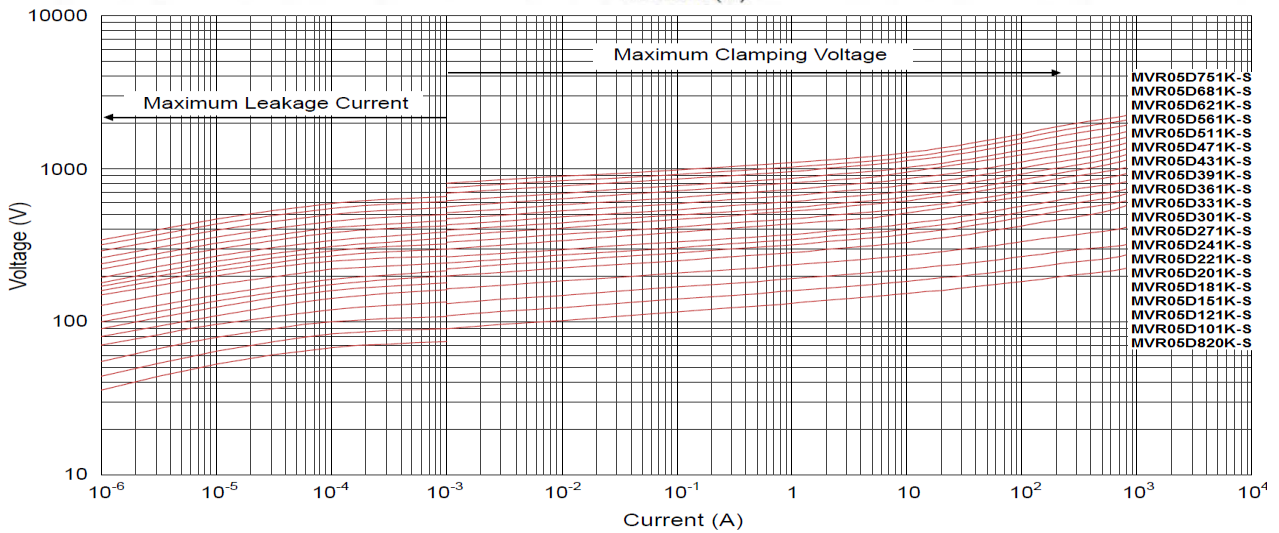
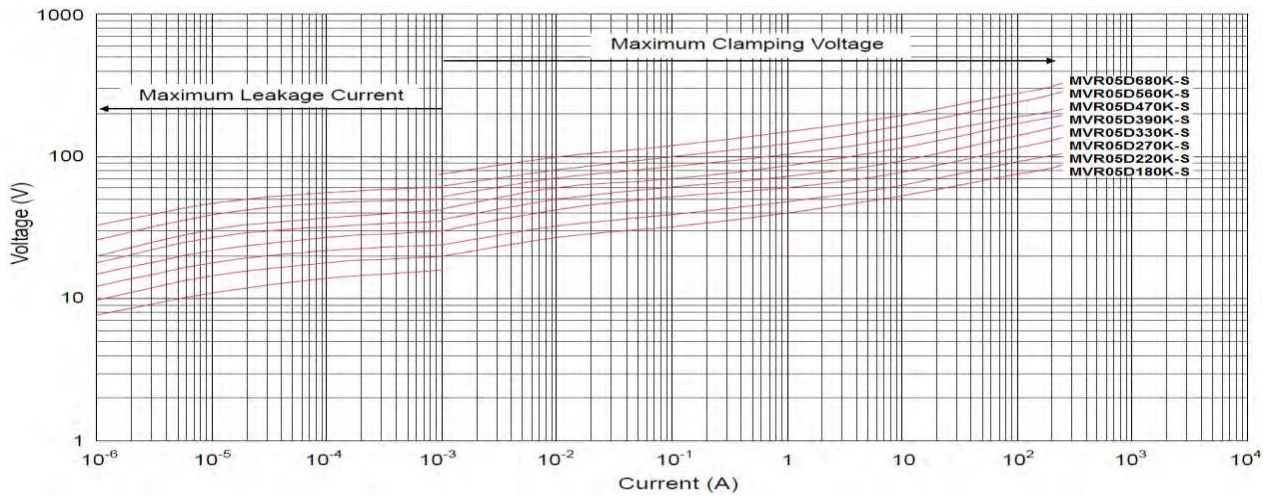

Metal Oxide Varistor High Surge Type, 5~20mm

MVR-S Series

MERITEK

ELECTRICAL CHARACTERISTICS - MVR07D-S SERIES

[Back to Top](#)

MVR07D-S Series	Varistor DC Voltage @1mA		Max. Allowable Voltage		Max. Clamping Voltage		Withstanding Surge Current	Max. Energy (10/1K μ s)	Rated Power	Typical Cap. @1KHz	Dimension	
	V _{DC}	V _{ACrms}	V _{DC}	V _c	I _p	(A)					(J)	(W)
	(V)	(V)	(V)	(V)	(A)							
MVR07D180K-S	18(15~21.6)	11	14	36	2.5	500	0.02	3.0	2800	4.5	1.3	
MVR07D220K-S	22(19.5~26)	14	18	43				2.4	2300	4.6	1.4	
MVR07D270K-S	27(24~31)	17	22	53				3.0	1800	4.7	1.6	
MVR07D330K-S	33(29.5~36.5)	20	26	65				3.5	1500	4.9	1.5	
MVR07D390K-S	39(35~43)	25	31	77				4.0	1300	4.8	1.6	
MVR07D470K-S	47(42~52)	30	38	93				5.0	1100	4.9	1.7	
MVR07D560K-S	56(50~62)	35	45	110				6.0	890	5.0	1.9	
MVR07D680K-S	68(61~75)	40	56	135				7.0	740	5.2	2.2	
MVR07D820K-S	82(74~90)	50	65	135	10	1,750	0.25	10.0	600	4.1	1.6	
MVR07D101K-S	100(90~110)	60	85	165				12.0	500	4.3	1.8	
MVR07D121K-S	120(108~132)	75	100	200				13.0	420	4.5	2.0	
MVR07D151K-S	150(135~165)	95	125	250				13.0	330	4.8	1.6	
MVR07D181K-S	180(162~198)	115	150	300				16.0	280	4.3	1.7	
MVR07D201K-S	200(180~220)	130	170	340				17.0	250	4.4	1.8	
MVR07D221K-S	220(198~242)	140	180	360				19.0	230	4.5	1.9	
MVR07D241K-S	240(216~264)	150	200	395				21.0	210	4.6	2.0	
MVR07D271K-S	270(243~297)	175	225	455				24.0	185	4.9	2.2	
MVR07D301K-S	300(270~330)	190	250	500				26.0	165	5.0	2.3	
MVR07D331K-S	330(297~363)	210	275	550				28.0	150	5.1	2.3	
MVR07D361K-S	360(324~396)	230	300	595				32.0	140	5.2	2.5	
MVR07D391K-S	390(351~429)	250	320	650				35.0	130	5.4	2.6	
MVR07D431K-S	430(387~473)	275	350	710				40.0	115	5.7	2.8	
MVR07D471K-S	470(423~517)	300	385	775				42.0	105	6.0	3.0	
MVR07D511K-S	510(459~561)	320	415	845				45.0	100	6.2	3.2	
MVR07D561K-S	560(504~616)	350	460	925				49.0	90	6.5	3.4	
MVR07D621K-S	620(558~682)	385	505	1025				55.0	80	7.1	3.7	
MVR07D681K-S	680(612~748)	420	560	1120				60.0	75	7.3	4.0	
MVR07D751K-S	750(675~825)	460	615	1240				65.0	70	7.0	4.1	
MVR07D781K-S	780(702~858)	485	640	1290	65.0	70	7.2	4.2				
MVR07D821K-S	820(738~902)	510	670	1355	70.0	60	7.5	4.4				

Notes:

- The tolerance of varistor voltage between 18V and 27V is more than 10%.
- Leakage Current (@83% of V_{1mA}) : IR \leq 50 μ A (180K~680K) IR \leq 25 μ A (820K~821K)

Metal Oxide Varistor High Surge Type, 5~20mm

MVR-S Series

MERITEK

SURGE CURRENT DERATING CURVES – MVR07D-S SERIES

[Back to Top](#)

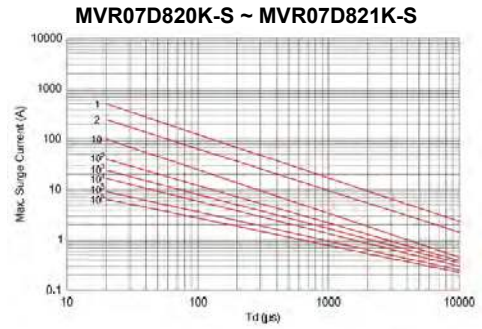
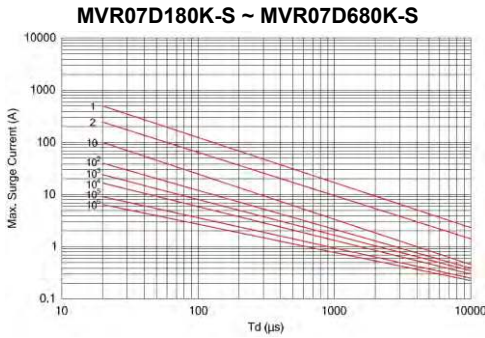

LEAKAGE CURRENT & CLAMPING VOLTAGE CURVES – MVR07-S SERIES

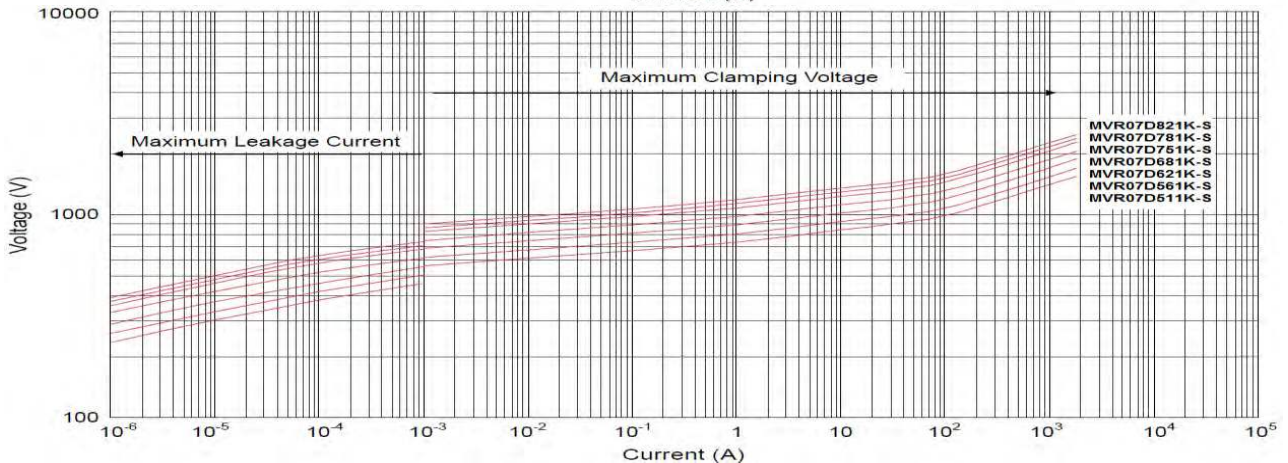
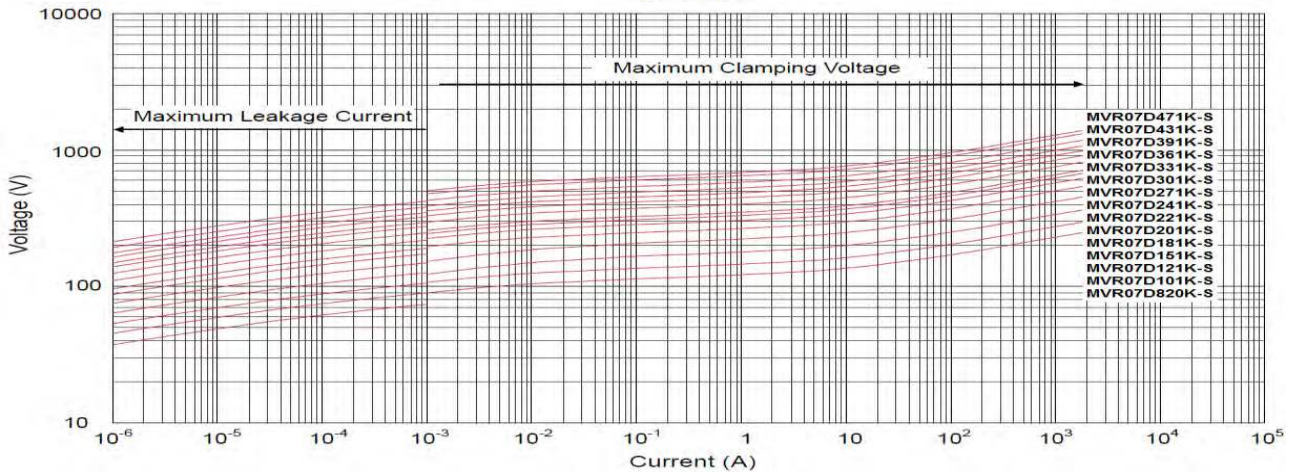
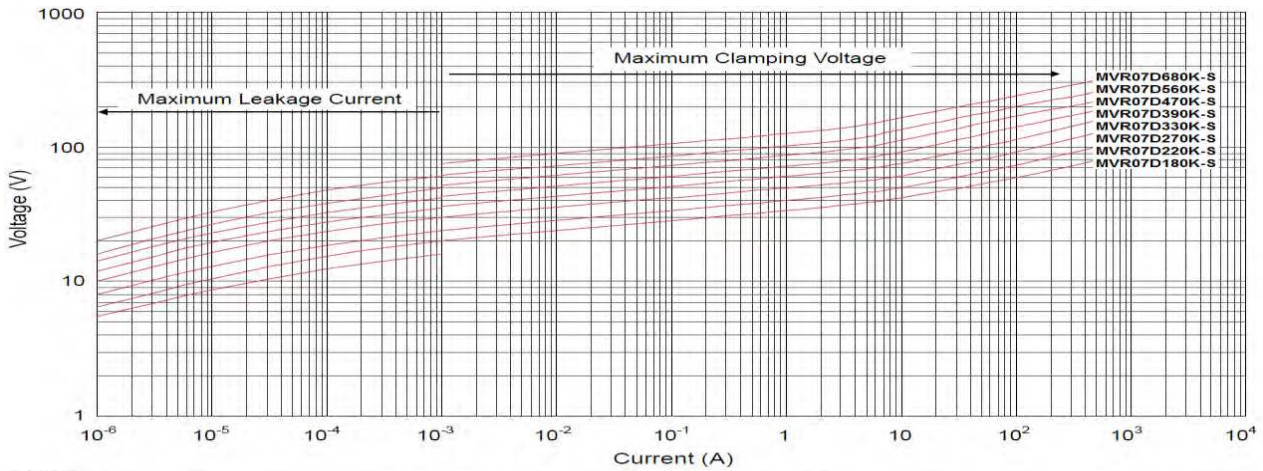

Metal Oxide Varistor High Surge Type, 5~20mm

MVR-S Series

MERITEK

ELECTRICAL CHARACTERISTICS – MVR10D-S SERIES

[Back to Top](#)

MVR10D-S Series	Varistor DC Voltage @1mA		Max. Allowable Voltage		Max. Clamping Voltage		Withstanding Surge Current (A)	Max. Energy (10/1K μ s) (J)	Rated Power (W)	Typical Cap. @1KHz (pF)	Dimension	
	V _{DC}	V _{ACrms}	V _{DC}	V _c	I _p	T max					e ± 0.8	
	(V)	(V)	(V)	(V)	(A)							
MVR10D180K-S	18(15~21.6)	11	14	36	5	1,000	0.05	3.0	0.05	5600	4.6	1.5
MVR10D220K-S	22(19.5~26)	14	18	43				5.0		4500	4.7	1.6
MVR10D270K-S	27(24~31)	17	22	53				6.0		3700	4.8	1.8
MVR10D330K-S	33(29.5~36.5)	20	26	65				7.0		3000	5.0	1.7
MVR10D390K-S	39(35~43)	25	31	77				9.0		2400	5.3	1.8
MVR10D470K-S	47(42~52)	30	38	93				11.0		2100	5.4	1.9
MVR10D560K-S	56(50~62)	35	45	110				13.0		1800	5.5	2.1
MVR10D680K-S	68(61~75)	40	56	135				15.0		1500	5.6	2.4
MVR10D820K-S	82(74~90)	50	65	135	25	3,500	0.4	17.0	0.4	1200	4.7	1.8
MVR10D101K-S	100(90~110)	60	85	165				18.0		1000	4.9	2.0
MVR10D121K-S	120(108~132)	75	100	200				21.0		830	5.1	2.2
MVR10D151K-S	150(135~165)	95	125	250				25.0		670	5.4	1.8
MVR10D181K-S	180(162~198)	115	150	300				30.0		560	4.8	1.9
MVR10D201K-S	200(180~220)	130	170	340				35.0		500	5.0	2.0
MVR10D221K-S	220(198~242)	140	180	360				39.0		450	5.1	2.1
MVR10D241K-S	240(216~264)	150	200	395				42.0		420	5.2	2.2
MVR10D271K-S	270(243~297)	175	225	455				49.0		370	5.4	2.4
MVR10D301K-S	300(270~330)	190	250	500				54.0		330	5.5	2.5
MVR10D331K-S	330(297~363)	210	275	550				58.0		300	5.8	2.5
MVR10D361K-S	360(324~396)	230	300	595				65.0		280	6.0	2.7
MVR10D391K-S	390(351~429)	250	320	650				70.0		260	6.2	2.8
MVR10D431K-S	430(387~473)	275	350	710				80.0		230	6.5	3.0
MVR10D471K-S	470(423~517)	300	385	775				85.0		210	6.7	3.2
MVR10D511K-S	510(459~561)	320	415	845				90.0		200	6.8	3.4
MVR10D561K-S	560(504~616)	350	460	925				92.0		180	7.0	3.6
MVR10D621K-S	620(558~682)	385	505	1025				95.0		160	7.3	3.9
MVR10D681K-S	680(612~748)	420	560	1120				98.0		150	7.6	4.2
MVR10D751K-S	750(675~825)	460	615	1240				100.0		130	8.0	4.3
MVR10D781K-S	780(702~858)	485	640	1290	105.0	130	8.1	4.4				
MVR10D821K-S	820(738~902)	510	670	1355	110.0	120	8.3	4.6				
MVR10D911K-S	910(819~1001)	550	745	1500	130.0	110	8.8	5.0				
MVR10D102K-S	1000(900~1100)	625	825	1650	140.0	100	9.3	5.0				
MVR10D112K-S	1100(990~1210)	680	895	1815	155.0	90	9.9	5.4				

Notes:

- The tolerance of varistor voltage between 18V and 27V is more than 10%.
- Leakage Current (@83% of V_{1mA}) : IR \leq 50 μ A (180K~680K) IR \leq 25 μ A (820K~112K)

Metal Oxide Varistor High Surge Type, 5~20mm

MVR-S Series

MERITEK

SURGE CURRENT DERATING CURVES – MVR10D-S SERIES

[Back to Top](#)

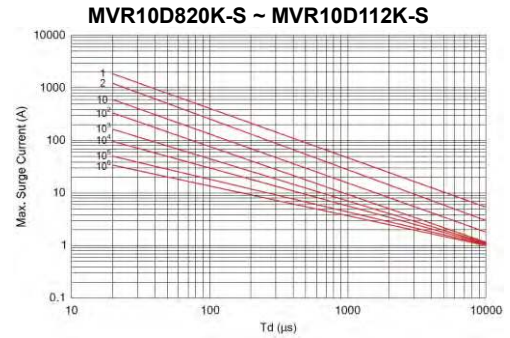
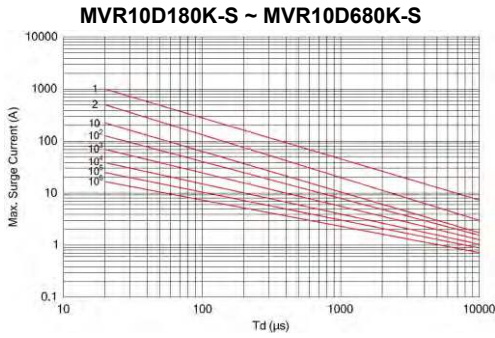

LEAKAGE CURRENT & CLAMPING VOLTAGE CURVES – MVR10D-S SERIES

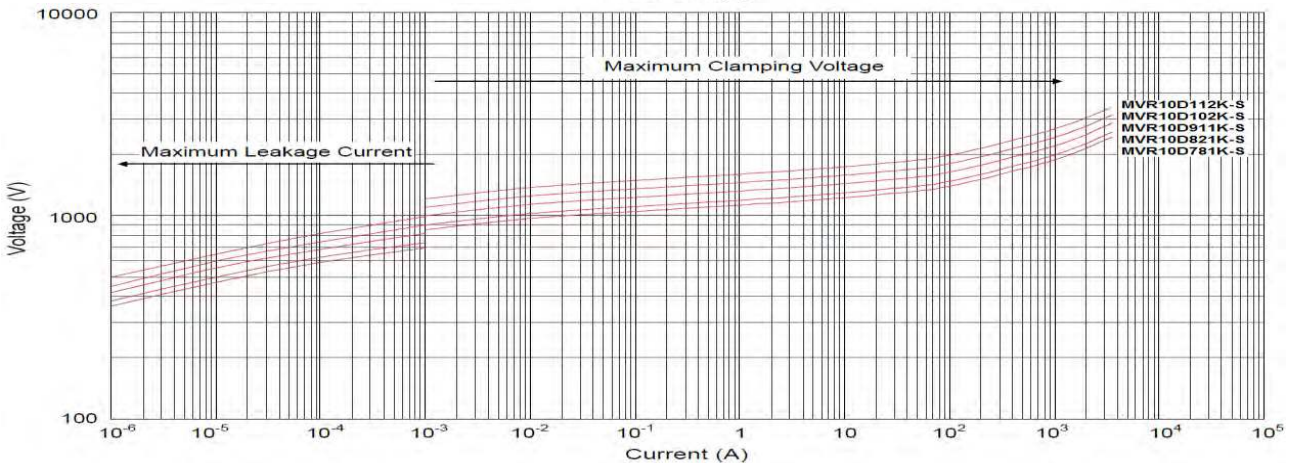
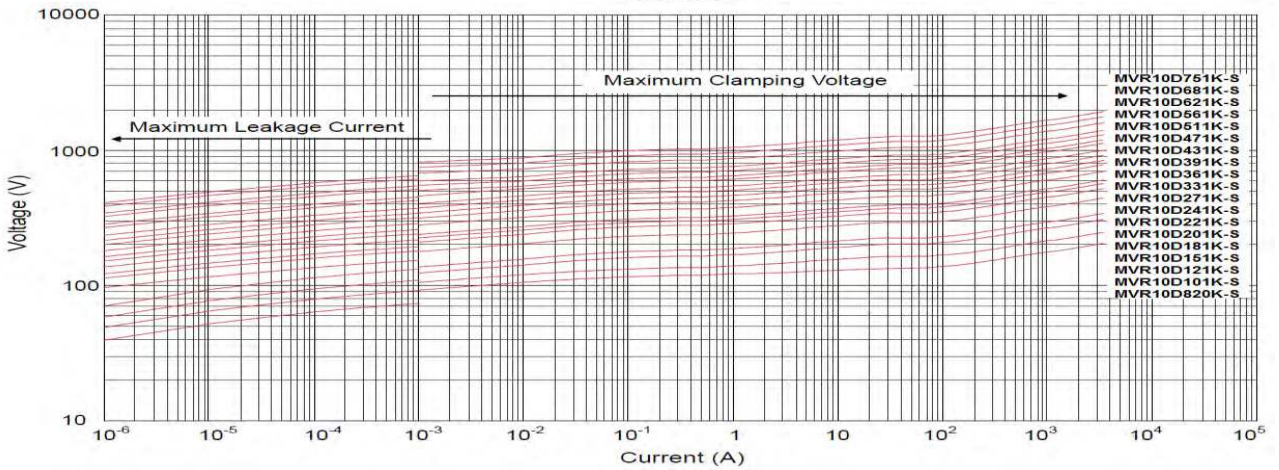
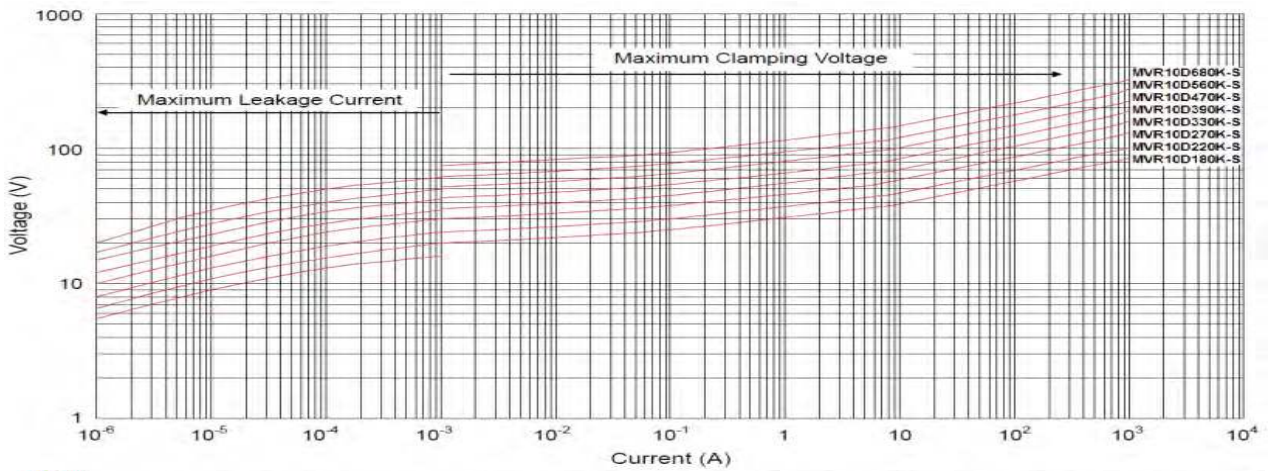

Metal Oxide Varistor High Surge Type, 5~20mm

MVR-S Series

MERITEK

ELECTRICAL CHARACTERISTICS – MVR14D-S SERIES

[Back to Top](#)

MVR14D-S Series	Varistor DC Voltage @1mA		Max. Allowable Voltage		Max. Clamping Voltage		Withstanding Surge Current (A)	Max. Energy (10/1K μ s) (J)	Rated Power (W)	Typical Cap. @1KHz (pF)	Dimension	
	V _{DC}	V _{ACrms}	V _{DC}	V _c	I _p	T _{max}					e \pm 0.8	
	(V)	(V)	(V)	(V)	(A)							
MVR14D180K-S	18(15~21.6)	11	14	36	10	2,000	0.1	7.0	11100	3.9	1.5	
MVR14D220K-S	22(19.5~26)	14	18	43				8.0	9100	4.0	1.6	
MVR14D270K-S	27(24~30)	17	22	53				10.0	7400	4.1	1.8	
MVR14D330K-S	33(29.5~36.5)	20	26	65				12.0	6100	4.3	1.7	
MVR14D390K-S	39(35~43)	25	31	77				13.0	5100	4.1	1.8	
MVR14D470K-S	47(42~52)	30	38	93				17.0	4300	4.3	1.9	
MVR14D560K-S	56(50~62)	35	45	110				20.0	3600	4.6	2.1	
MVR14D680K-S	68(61~75)	40	56	135				24.0	2900	4.8	2.4	
MVR14D820K-S	82(74~90)	50	65	135	50	6,000	0.6	27.0	2400	4.1	1.8	
MVR14D101K-S	100(90~110)	60	85	165				33.0	2000	4.2	2.0	
MVR14D121K-S	120(108~132)	75	100	200				40.0	1700	4.4	2.2	
MVR14D151K-S	150(135~165)	95	125	250				53.0	1300	4.1	1.8	
MVR14D181K-S	180(162~198)	115	150	300				60.0	1100	4.2	1.9	
MVR14D201K-S	200(180~220)	130	170	340				70.0	1000	4.3	2.0	
MVR14D221K-S	220(198~242)	140	180	360				78.0	900	4.4	2.1	
MVR14D241K-S	240(216~264)	150	200	395				84.0	830	4.5	2.2	
MVR14D271K-S	270(243~297)	175	225	455				99.0	740	4.6	2.4	
MVR14D301K-S	300(270~330)	190	250	500				108	670	4.6	2.5	
MVR14D331K-S	330(297~363)	210	275	550				115	610	5.0	2.5	
MVR14D361K-S	360(324~396)	230	300	595				130	560	5.2	2.7	
MVR14D391K-S	390(351~429)	250	320	650				140	510	5.4	2.8	
MVR14D431K-S	430(387~473)	275	350	710				155	460	5.6	3.0	
MVR14D471K-S	470(423~517)	300	385	775				175	430	5.8	3.2	
MVR14D511K-S	510(459~561)	320	415	845				180	390	6.1	3.4	
MVR14D561K-S	560(504~616)	350	460	925				185	360	6.4	3.6	
MVR14D621K-S	620(558~682)	385	505	1025				190	320	6.8	3.9	
MVR14D681K-S	680(621~748)	420	560	1120				200	290	7.1	4.2	
MVR14D751K-S	750(675~825)	460	615	1240				210	270	7.2	4.3	
MVR14D781K-S	780(702~858)	485	640	1290				220	260	7.3	4.4	
MVR14D821K-S	820(738~902)	510	670	1355				235	240	7.5	4.6	
MVR14D911K-S	910(819~1001)	550	745	1500				255	220	7.5	5.0	
MVR14D102K-S	1000(900~1100)	625	825	1650				280	200	8.0	5.0	
MVR14D112K-S	1100(990~1210)	680	895	1815	310	180	8.5	5.4				
MVR14D122K-S	1200(1080~1320)	750	990	1980	324	160	9.0	5.8				
MVR14D142K-S	1400(1260~1540)	880	1140	2310	327	150	10.5	6.6				
MVR14D162K-S	1600(1440~1760)	1000	1280	2640	331	140	11.0	7.4				
MVR14D182K-S	1800(1620~1980)	1100	1465	2970	335	130	12.0	8.2				

Notes:

- The tolerance of varistor voltage between 18V and 27V is more than 10%.
- Varistor voltage \geq 1200V, structure diagram is F type.
- Leakage Current (@83% of V_{1mA}) : IR \leq 50 μ A (180K~680K) ; IR \leq 25 μ A (820K~182K)

Metal Oxide Varistor High Surge Type, 5~20mm

MVR-S Series

MERITEK

SURGE CURRENT DERATING CURVES – MVR14D-S SERIES

[Back to Top](#)

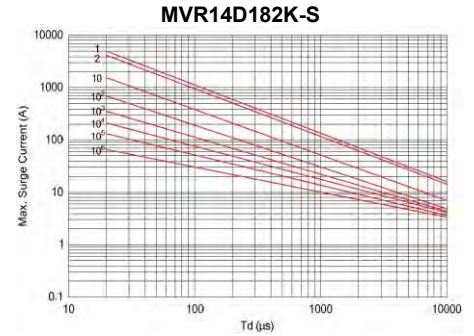
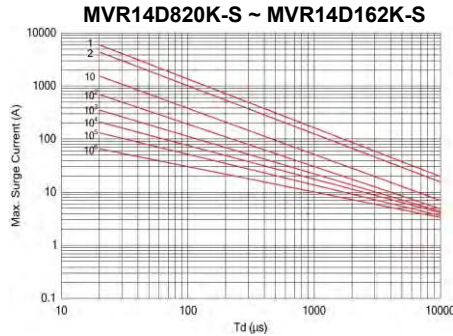
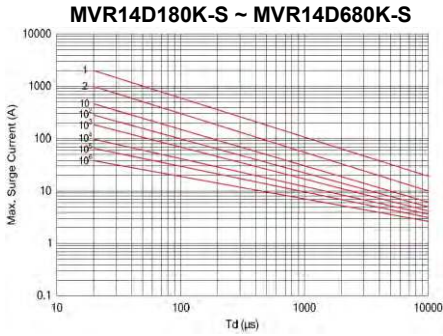

LEAKAGE CURRENT & CLAMPING VOLTAGE CURVES – MVR14D-S SERIES

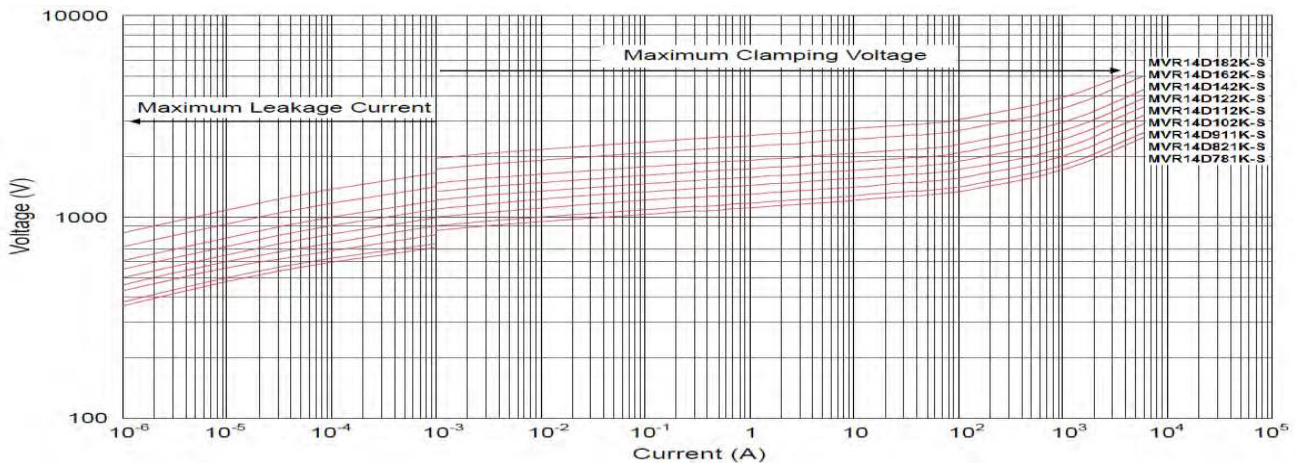
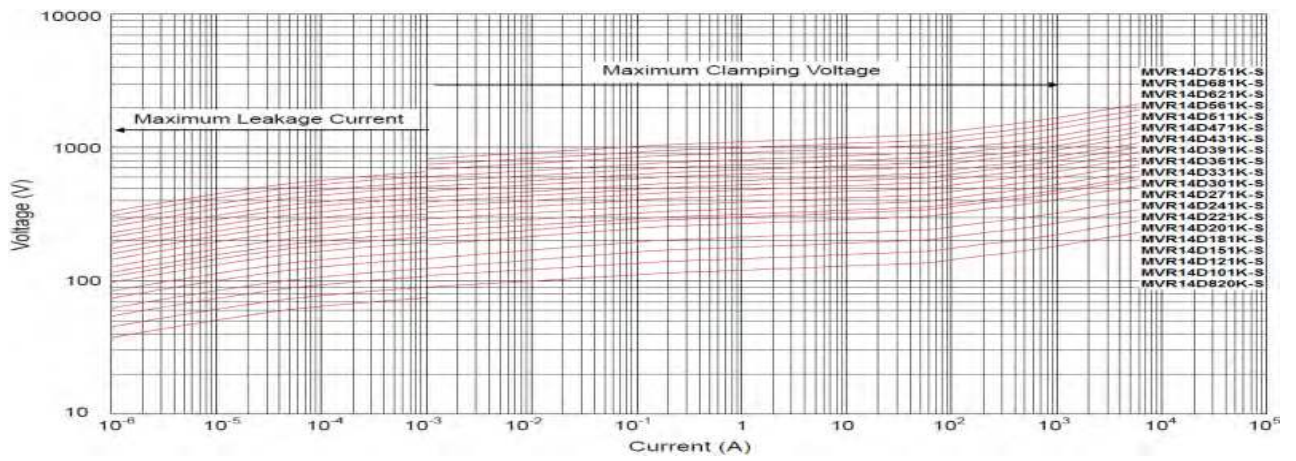
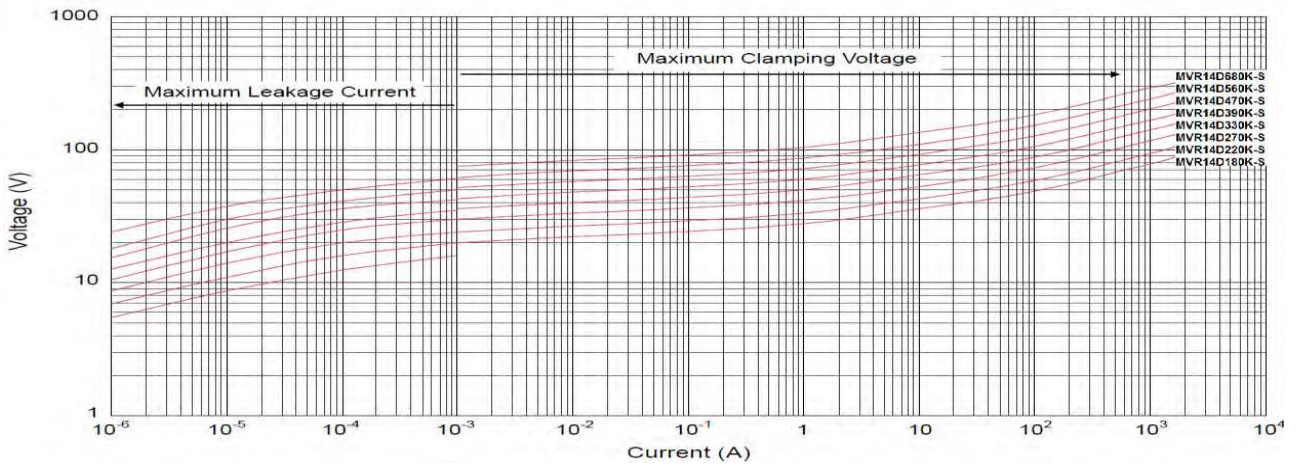

Metal Oxide Varistor High Surge Type, 5~20mm

MVR-S Series

MERITEK

ELECTRICAL CHARACTERISTICS – MVR20D-S SERIES

[Back to Top](#)

MVR20D-S Series	Varistor DC Voltage @1mA		Max. Allowable Voltage		Max. Clamping Voltage		Withstanding Surge Current	Max. Energy (10/1K μ s)	Rated Power	Typical Cap. @1KHz	Dimension	
	V _{DC}	V _{AC}	V _{DC}	V _C	I _P	T max					e ± 0.8	
	(V)	(V)	(V)	(V)	(A)		(A)	(J)	(W)	(pF)		
MVR20D180K-S	18(16~20)	11	14	36	20	3,000	0.2	13	28500	4.3	1.7	
MVR20D220K-S	22(20~24)	14	18	43				16	18500	4.4	1.8	
MVR20D270K-S	27(24~30)	17	22	53				19	13000	4.6	2.0	
MVR20D330K-S	33(30~36)	20	26	65				24	11500	4.8	1.9	
MVR20D390K-S	39(35~43)	25	31	77				28	8500	4.5	2.0	
MVR20D470K-S	47(42~52)	30	38	93				34	7400	4.7	2.1	
MVR20D560K-S	56(50~62)	35	45	110				41	6800	5.0	2.3	
MVR20D680K-S	68(61~75)	40	56	135				49	5800	5.3	2.6	
MVR20D820K-S	82(74~90)	50	65	135	100	10,000	1.0	56	4900	4.5	2.0	
MVR20D101K-S	100(90~110)	60	85	165				70	4000	4.6	2.2	
MVR20D121K-S	120(108~132)	75	100	200				85	3300	4.8	2.4	
MVR20D151K-S	150(135~165)	95	125	250				106	2700	4.5	2.0	
MVR20D181K-S	180(162~198)	115	150	300				130	2200	4.6	2.1	
MVR20D201K-S	200(185~225)	130	170	340				140	2000	4.7	2.2	
MVR20D221K-S	220(198~242)	140	180	360				155	1800	4.8	2.3	
MVR20D241K-S	240(216~264)	150	200	395				168	1650	4.9	2.4	
MVR20D271K-S	270(243~297)	175	225	455				190	1500	5.0	2.6	
MVR20D301K-S	300(270~330)	190	250	500				210	1300	5.0	2.7	
MVR20D331K-S	330(297~363)	210	275	550				228	1200	5.2	2.7	
MVR20D361K-S	360(324~396)	230	300	595				255	1100	5.4	2.9	
MVR20D391K-S	390(351~429)	250	320	650				275	1000	5.5	3.0	
MVR20D431K-S	430(387~473)	275	350	710				305	930	5.7	3.2	
MVR20D471K-S	470(423~517)	300	385	775				350	850	6.0	3.4	
MVR20D511K-S	510(459~561)	320	415	845				360	780	6.2	3.6	
MVR20D561K-S	560(504~616)	350	460	925				380	710	6.5	3.8	
MVR20D621K-S	620(558~682)	385	505	1025				390	650	6.8	4.1	
MVR20D681K-S	680(621~748)	420	560	1120				400	600	7.1	4.4	
MVR20D751K-S	750(675~825)	460	615	1240				420	530	7.5	4.5	
MVR20D781K-S	780(702~858)	485	640	1290				440	510	7.7	4.6	
MVR20D821K-S	820(738~902)	510	670	1355				460	500	7.9	4.8	
MVR20D911K-S	910(819~1001)	550	745	1500				510	440	8.1	5.2	
MVR20D102K-S	1000(900~1100)	625	825	1650				565	400	8.6	5.2	
MVR20D112K-S	1100(990~1210)	680	895	1815	620	360	9.1	5.6				
MVR20D122K-S	1200(1080~1320)	750	990	1980	660	350	9.7	6.0				
MVR20D142K-S	1400(1260~1540)	880	1140	2310	784	340	11.2	6.8				
MVR20D162K-S	1600(1440~1760)	1000	1280	2640	896	330	11.8	7.6				
MVR20D182K-S	1800(1620~1980)	1100	1465	2970	990	320	12.8	8.4				

Notes:

1. The tolerance of varistor voltage between 18V and 27V is more than 10%.
2. Varistor voltage $\geq 1200V$, structure diagram is F type.
3. Leakage Current (@83% of V_{1mA}) : IR $\leq 50\mu A$ (180K~680K) ; IR $\leq 25\mu A$ (820K~182K)

Metal Oxide Varistor High Surge Type, 5~20mm

MVR-S Series

MERITEK

SURGE CURRENT DERATING CURVES – MVR20D-S SERIES

[Back to Top](#)

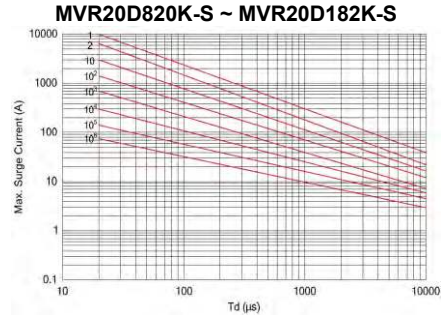
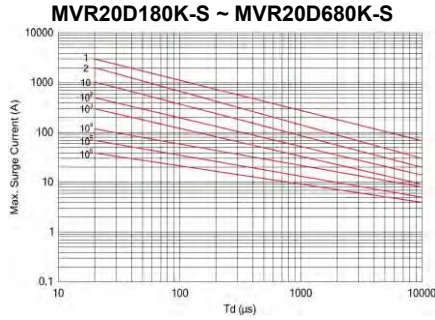

LEAKAGE CURRENT & CLAMPING VOLTAGE CURVES – MVR20D-S SERIES

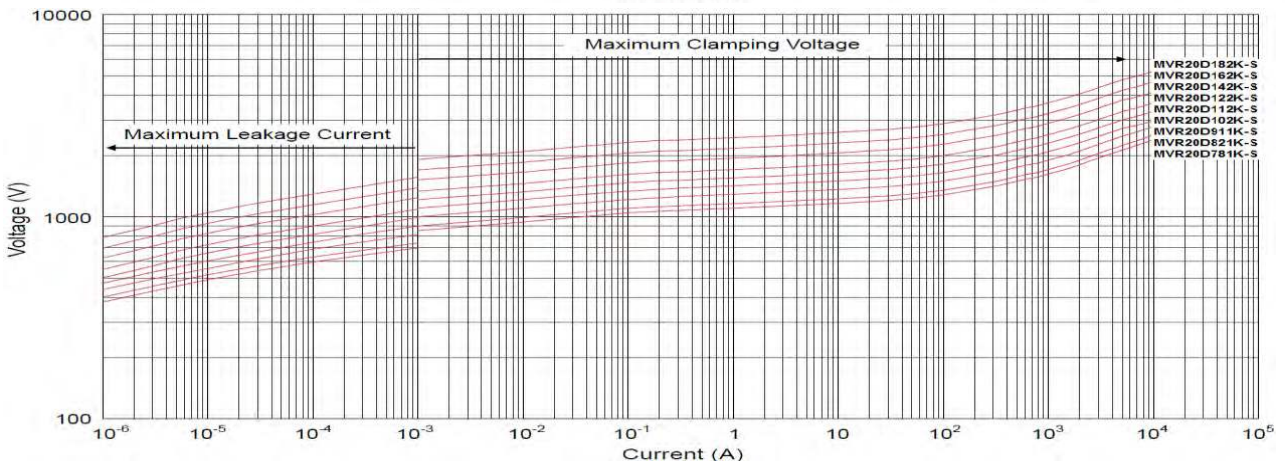
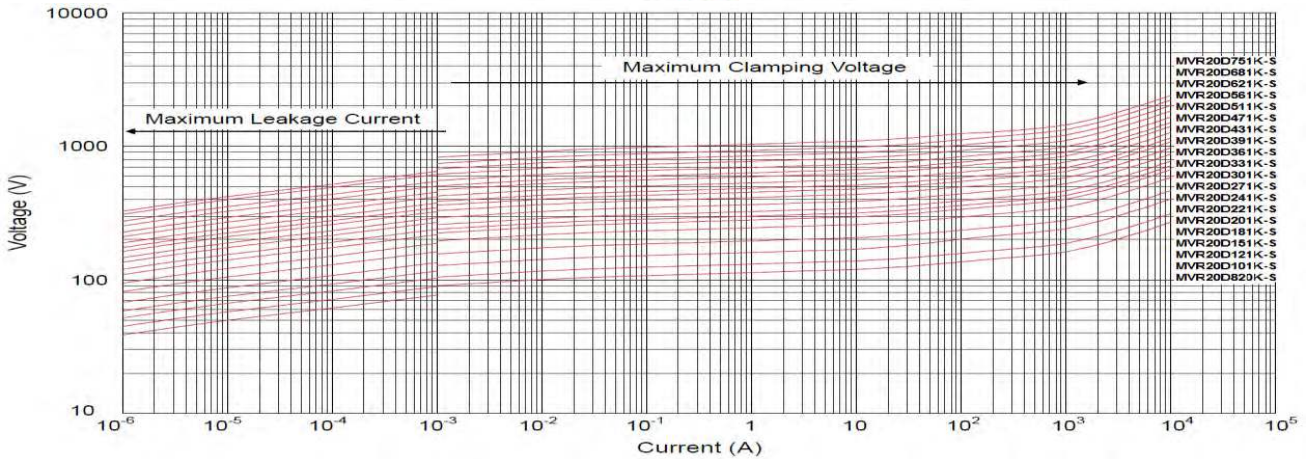
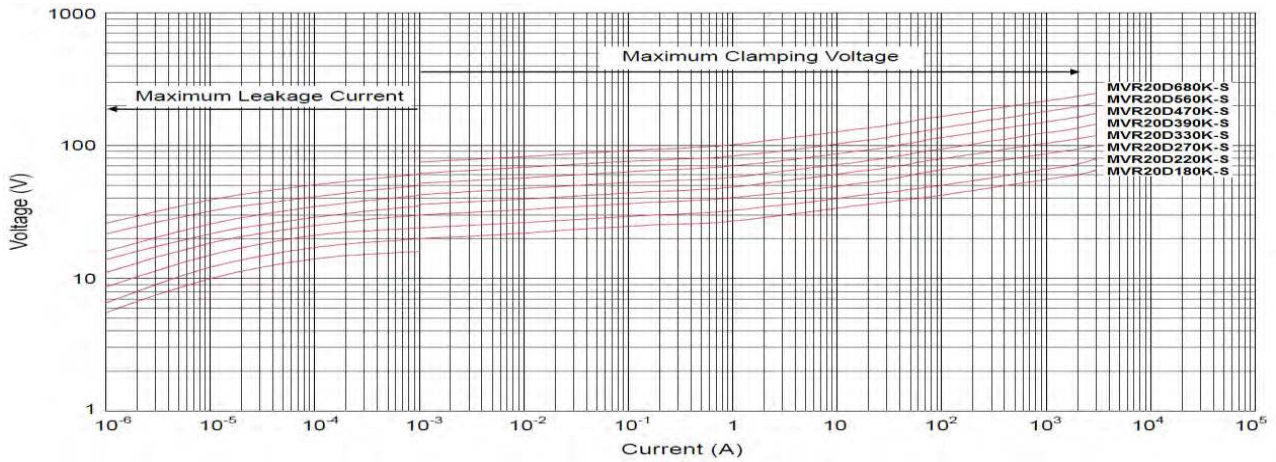

Metal Oxide Varistor High Surge Type, 5~20mm

MVR-S Series

MERITEK

RELIABILITY TEST CONDITIONS AND REQUIREMENTS

[Back To Top](#)

Item	Test Conditions / Method	Specifications																				
Tensile Strength of Terminals	<p>Gradually apply the specified force and keep the unit fixed for 10±1s.</p> <table border="1"> <thead> <tr> <th>Terminal diameter (mm)</th> <th>Force (Kg)</th> </tr> </thead> <tbody> <tr> <td>0.5<d ≤ 0.8</td> <td>1.0</td> </tr> <tr> <td>0.8<d ≤ 1.25</td> <td>2.0</td> </tr> <tr> <td>1.25<d</td> <td>4.0</td> </tr> </tbody> </table>	Terminal diameter (mm)	Force (Kg)	0.5<d ≤ 0.8	1.0	0.8<d ≤ 1.25	2.0	1.25<d	4.0	$ \Delta V_{1mA} / V_{1mA} \leq 5\%$ No visible damage												
Terminal diameter (mm)	Force (Kg)																					
0.5<d ≤ 0.8	1.0																					
0.8<d ≤ 1.25	2.0																					
1.25<d	4.0																					
Bending Strength of Terminals	<p>Hold specimen and apply the force specified below to each lead. Bend the specimen to 90°, and then return to the original position. Repeat the procedure in the opposite direction.</p> <table border="1"> <thead> <tr> <th>Terminal diameter (mm)</th> <th>Force (Kg)</th> </tr> </thead> <tbody> <tr> <td>0.5<d ≤ 0.8</td> <td>0.5</td> </tr> <tr> <td>0.8<d ≤ 1.25</td> <td>1.0</td> </tr> <tr> <td>1.25<d</td> <td>2.0</td> </tr> </tbody> </table>	Terminal diameter (mm)	Force (Kg)	0.5<d ≤ 0.8	0.5	0.8<d ≤ 1.25	1.0	1.25<d	2.0	$ \Delta V_{1mA} / V_{1mA} \leq 5\%$ No visible damage												
Terminal diameter (mm)	Force (Kg)																					
0.5<d ≤ 0.8	0.5																					
0.8<d ≤ 1.25	1.0																					
1.25<d	2.0																					
Vibration	Frequency range: 10 ~ 55 Hz, Amplitude: 0.75mm or 98 m/s ² Direction: 3 mutually perpendicular directions, 2 hrs. each.	$ \Delta V_{1mA} / V_{1mA} \leq 5\%$ No visible damage																				
Solderability	245±5°C , 2±0.5 sec	At least 95% of terminal electrode is covered by solder																				
Resistance to Soldering Heat	260±5°C , 10±1 sec	$ \Delta V_{1mA} / V_{1mA} \leq 5\%$ No visible damage																				
High Temperature Storage	125±2°C x 1000 hrs.	$ \Delta V_{1mA} / V_{1mA} \leq 5\%$ No visible damage																				
Low Temperature Storage	-40±2°C x 1000 hrs.	$ \Delta V_{1mA} / V_{1mA} \leq 5\%$ No visible damage																				
Damp Heat, Steady State	1000 hrs. at 40±2°C, 90 ~ 95 % RH, at max. allowable voltage	$ \Delta V_{1mA} / V_{1mA} \leq 10\%$ No visible damage																				
Rapid Change of Temperature	The conditions shown below shall be repeated 5 cycles. <table border="1"> <thead> <tr> <th>Step</th> <th>Temperature (°C)</th> <th>Period (minutes)</th> </tr> </thead> <tbody> <tr> <td>1</td> <td>-40±3</td> <td>30±3</td> </tr> <tr> <td>2</td> <td>Room temperature</td> <td>5±3</td> </tr> <tr> <td>3</td> <td>125±3</td> <td>30±3</td> </tr> <tr> <td>4</td> <td>Room temperature</td> <td>5±3</td> </tr> </tbody> </table>	Step	Temperature (°C)	Period (minutes)	1	-40±3	30±3	2	Room temperature	5±3	3	125±3	30±3	4	Room temperature	5±3	$ \Delta V_{1mA} / V_{1mA} \leq 5\%$ No visible damage					
Step	Temperature (°C)	Period (minutes)																				
1	-40±3	30±3																				
2	Room temperature	5±3																				
3	125±3	30±3																				
4	Room temperature	5±3																				
High Temperature Load Life	1000 hrs. at 105±2°C, Max allowable AC Voltage	$ \Delta V_{1mA} / V_{1mA} \leq 10\%$ No visible damage																				
Voltage Proof	Metal balls method, 2500 V _{AC} 1 min	No visible damage																				
Surge Life (8/20µs)	The change of varistor voltage (V _{1mA}) shall be measured after the impulse listed below is applied 10,000 times continuously with the interval of ten seconds at room temperature. <table border="1"> <tbody> <tr> <td rowspan="2">05D Series</td> <td>108K to 680K</td> <td>10A (8/20µs)</td> </tr> <tr> <td>820K to 751K</td> <td>20A (8/20µs)</td> </tr> <tr> <td rowspan="2">10D Series</td> <td>180K to 680K</td> <td>50A (8/20µs)</td> </tr> <tr> <td>820K to 112K</td> <td>100A (8/20µs)</td> </tr> <tr> <td rowspan="2">14D Series</td> <td>180K to 680K</td> <td>75A (8/20µs)</td> </tr> <tr> <td>820K to 182K</td> <td>150A (8/20µs)</td> </tr> <tr> <td rowspan="2">20D Series</td> <td>180K to 680K</td> <td>100A (8/20µs)</td> </tr> <tr> <td>820K to 182K</td> <td>200A (8/20µs)</td> </tr> </tbody> </table>	05D Series	108K to 680K	10A (8/20µs)	820K to 751K	20A (8/20µs)	10D Series	180K to 680K	50A (8/20µs)	820K to 112K	100A (8/20µs)	14D Series	180K to 680K	75A (8/20µs)	820K to 182K	150A (8/20µs)	20D Series	180K to 680K	100A (8/20µs)	820K to 182K	200A (8/20µs)	$ \Delta V_{1mA} / V_{1mA} \leq 10\%$ No visible damage
05D Series	108K to 680K		10A (8/20µs)																			
	820K to 751K	20A (8/20µs)																				
10D Series	180K to 680K	50A (8/20µs)																				
	820K to 112K	100A (8/20µs)																				
14D Series	180K to 680K	75A (8/20µs)																				
	820K to 182K	150A (8/20µs)																				
20D Series	180K to 680K	100A (8/20µs)																				
	820K to 182K	200A (8/20µs)																				

Metal Oxide Varistor High Surge Type, 5~20mm

MVR-S Series

MERITEK

RELIABILITY TEST CONDITIONS AND REQUIREMENTS (CONTINUED) [Back To Top](#)

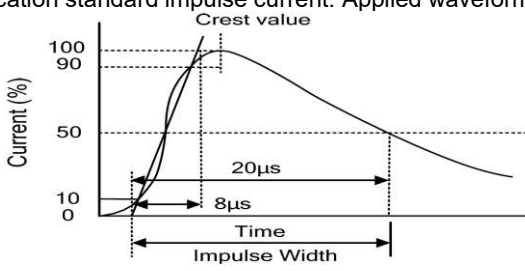
Item	Test Conditions / Method	Specifications
Varistor Voltage Temp. Coefficient	$\frac{V_{1mA} \text{ at } 85^{\circ}C - V_{1mA} \text{ at } 25^{\circ}C}{V_{1mA} \text{ at } 25^{\circ}C} \times \frac{1}{80} \times 100(\%/^{\circ}C)$ $\frac{V_{1mA} \text{ at } -40^{\circ}C - V_{1mA} \text{ at } 25^{\circ}C}{V_{1mA} \text{ at } 25^{\circ}C} \times \frac{1}{65} \times 100(\%/^{\circ}C)$	-0.05≤TC≤0.05(%/°C)
Varistor Voltage	The voltage between two terminals with the specified measuring current 1mA. DC applied is called V _{1mA} .	To meet the Specified Value
Maximum Allowable Voltage	The recommended maximum sine wave voltage (RMS) or the Maximum DC voltage can be applied continuously.	
Maximum Clamping Voltage	The maximum voltage between two terminals with the specification standard impulse current. Applied waveform: 8/20μs 	
Rated Voltage	The maximum average power that can be applied within the specified ambient temperature.	
Energy	The maximum energy within the varistor voltage change of ±10% when one impulse of 10/1000μs or 2ms is applied.	
Withstanding Surge Current	The maximum current within the varistor voltage change of ±10% with the standard impulse current (8/20μs) applied one time.	

SOLDERING RECOMMENDATION

Wave Soldering Process	Condition
Peak Temperature	265°C (max.)
Dipping Time	10 sec. (max.)
Soldering	1 time

Soldering Iron Process	Condition
Temperature of Soldering Iron-tip	360°C (max.)
Soldering Time	3 sec. (max.)
Distance From Varistor	2 mm (min.)

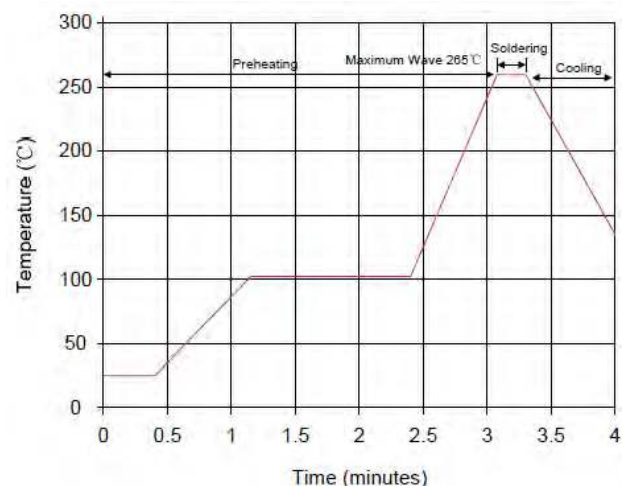

Meritek Varistor Series: <http://www.meritekusa.com/EN/productlist/node/15>

Meritek Product Series: <http://www.meritekusa.com/EN/products>

*Specifications subject to change without notice.