



PIDG

TE Internal #: 165565-1

Quick Disconnects, Receptacle, 22 – 16 AWG Wire Size, .3 – 1.5 mm² Wire Size, 592 – 2960 CMA Wire Size, Mating Tab Width 2.79 mm [.11 in], PIDG

[View on TE.com >](#)

Terminals & Splices > Quick Disconnects > PIDG FASTON Receptacle Quick Disconnects

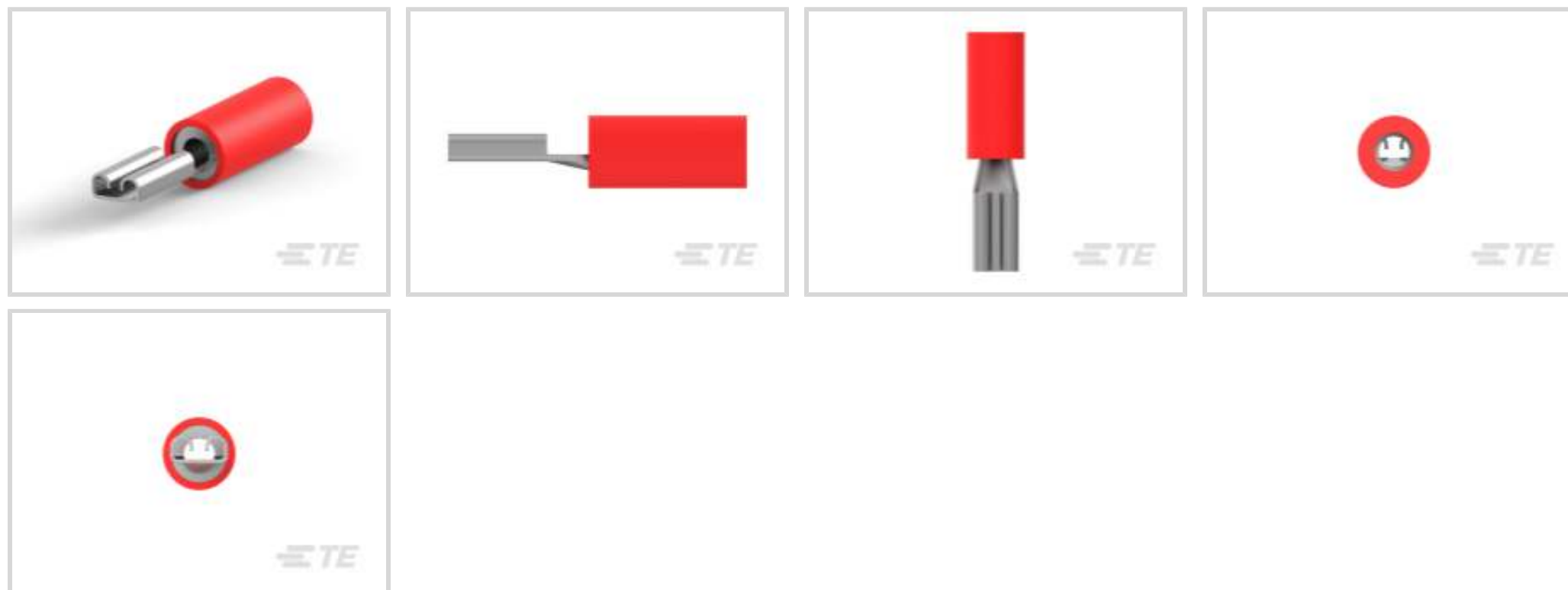

Quick Disconnect Terminal Type: **Receptacle**

Wire Size: **592 – 2960 CMA**

Mating Tab Width: **2.79 mm [.11 in]**

[All PIDG FASTON Receptacle Quick Disconnects \(21\)](#)

Features

Product Type Features

Insertion Force	Normal
-----------------	--------

Configuration Features

Connection Capacity	Single
---------------------	--------

Electrical Characteristics

Voltage Rating	300 V
----------------	-------

Body Features

Insulation Material	Nylon
---------------------	-------

Contact Features

Quick Disconnect Terminal Type	Receptacle
Mating Tab Width	2.79 mm [.11 in]
Mating Tab Thickness	.51 mm [.02 in]
Terminal Orientation	Straight
Contact Base Material	Brass



Terminal Plating Material	Tin
---------------------------	-----

Crimp Type	Compression
------------	-------------

Barrel Type	Closed
-------------	--------

Termination Features

Product Terminates To	Wire & Cable
-----------------------	--------------

Mechanical Attachment

Wire Insulation Support	With
-------------------------	------

Mating Retention Type	Dimple
-----------------------	--------

Dimensions

Product Length	19.8 mm[.779 in]
----------------	------------------

Compatible Insulation Diameter Range	3.5 mm[.14 in]
--------------------------------------	----------------

Wire Size	592 – 2960 CMA
-----------	----------------

Usage Conditions

Insulation Option	Partially Insulated
-------------------	---------------------

Operating Temperature Range	105 °C[221 °F]
-----------------------------	----------------

Packaging Features

Packaging Quantity	1000
--------------------	------

Packaging Method	Loose Piece
------------------	-------------

Other

Barrel Color	Red
--------------	-----

Product Compliance

[For compliance documentation, visit the product page on TE.com>](#)

EU RoHS Directive 2011/65/EU	Compliant
------------------------------	-----------

EU ELV Directive 2000/53/EC	Compliant
-----------------------------	-----------

China RoHS 2 Directive MIIT Order No 32, 2016	No Restricted Materials Above Threshold
---	---

EU REACH Regulation (EC) No. 1907/2006	Current ECHA Candidate List: JUNE 2023 (235) Candidate List Declared Against: JUNE 2023 (235) Does not contain REACH SVHC
--	---

Halogen Content	Low Halogen - Br, Cl, F, I < 900 ppm per homogenous material. Also BFR/CFR/PVC Free
-----------------	---













Solder Process Capability

Not applicable for solder process capability

Product Compliance Disclaimer

This information is provided based on reasonable inquiry of our suppliers and represents our current actual knowledge based on the information they provided. This information is subject to change. The part numbers that TE has identified as EU RoHS compliant have a maximum concentration of 0.1% by weight in homogenous materials for lead, hexavalent chromium, mercury, PBB, PBDE, DBP, BBP, DEHP, DIBP, and 0.01% for cadmium, or qualify for an exemption to these limits as defined in the Annexes of Directive 2011/65/EU (RoHS2). Finished electrical and electronic equipment products will be CE marked as required by Directive 2011/65/EU. Components may not be CE marked. Additionally, the part numbers that TE has identified as EU ELV compliant have a maximum concentration of 0.1% by weight in homogenous materials for lead, hexavalent chromium, and mercury, and 0.01% for cadmium, or qualify for an exemption to these limits as defined in the Annexes of Directive 2000/53/EC (ELV). Regarding the REACH Regulation, the information TE provides on SVHC in articles for this part number is based on the latest European Chemicals Agency (ECHA) 'Guidance on requirements for substances in articles' posted at this URL: <https://echa.europa.eu/guidance-documents/guidance-on-reach>

Compatible Parts

 <p>REPRESENTATION ONLY</p> <p>TE Part # 47386-4 DAHT PG PIDG 26-16 ASSY</p>	 <p>TE Part # 58433-3 PRO CR ASSY, RBY IS9252</p>	 <p>TE Part # 58423-1 DIE, RBY IS9252</p>	 <p>TE Part # 8-1377174-1 SMP 0-0165565-1</p>
 <p>REPRESENTATION ONLY</p> <p>TE Part # 525690 DAHT PG PIDG 20-18 ASSY</p>	 <p>TE Part # 539691-2 ERGO DIE R.B.Y</p>	 <p>REPRESENTATION ONLY</p> <p>TE Part # 90035-3 DAHT PIDG FASTON 22-18 ASSY</p>	 <p>TE Part # 169400 CERTI-LOK FRAME W/O DIES</p>
 <p>TE Part # 1SET191001R0000 CRIMP-HT</p>	 <p>TE Part # 2392021-2 RED BATTERY DAHT KIT 220V (47689-4)</p>	 <p>TE Part # 2392021-1 RED BATTERY DAHT KIT 110V (47689-4)</p>	 <p>TE Part # 169404 CERTI-LOK DIE</p>

Also in the Series | PIDG



Compression Connectors(17)



Crimp Terminal Housings(1)



Crimp Wire Pins, Tabs & Ferrules(40)



Hand Crimping Tools(2)



Knife Disconnects(11)



PCB Terminals(9)

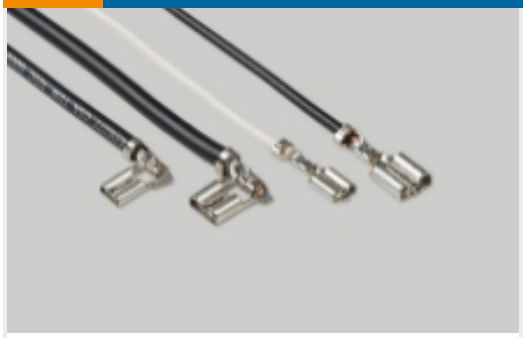

Quick Disconnects(49)



Ring Terminals & Spade Terminals(861)



Special Purpose Terminals(1)



Splices(47)

Customers Also Bought



TE Part #9-1625966-5
HSA10 33R 5%



TE Part #T4161220005-005
RPC-M12-MR-5CON-PUR-5.0SH



TE Part #1-2176054-3
RLP73N 2A R16 5% 5K RL



TE Part #2273100-3
M12 A-CODE MALE R/A PIGTAIL



TE Part #2-1825137-9
A105P3ZQ04

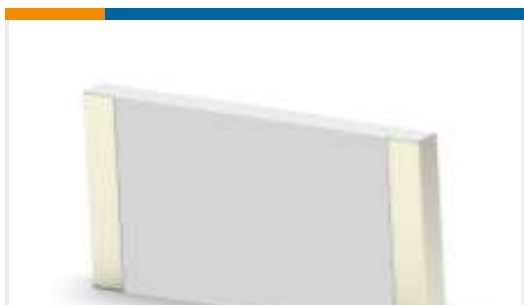

TE Part #2-2176246-3
CRGS2512 5% 68R



TE Part #2-1803395-4
ANVIL, COMBINATION, SMALL WIRE
APPLICATION

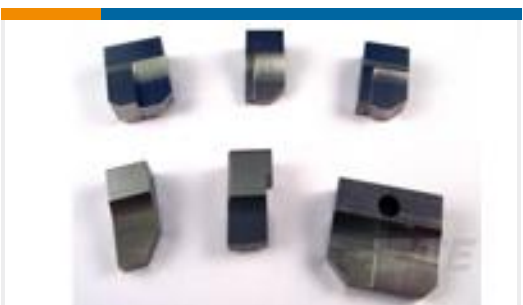

TE Part #7-1633139-3
ANVIL, COMBINATION

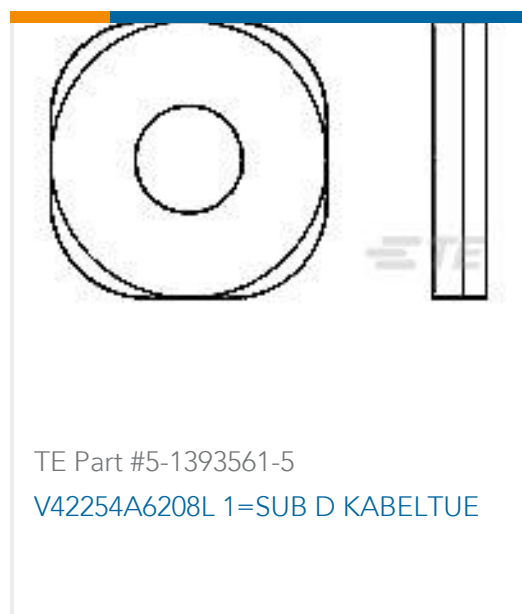

Documents

Product Drawings

2,8 PIDG FASTON REC

English

CAD Files

3D PDF

3D

Customer View Model

[ENG_CVM_CVM_165565-1_K.2d_dxf.zip](#)

English

Customer View Model

[ENG_CVM_CVM_165565-1_K.3d_igs.zip](#)

English

Customer View Model

[ENG_CVM_CVM_165565-1_K.3d_stp.zip](#)

English

By downloading the CAD file I accept and agree to the [Terms and Conditions](#) of use.

Datasheets & Catalog Pages

PIDG Terminals and Splices Quick Reference Guide

English

PIDG TERMINALS & SPLICES Quick Reference Guide

English

Product Environmental Compliance

MD_165565-1_041020151534_dmtec

English

MD_165565-1_041020151534_dmtec

English