



Single-Supply, 150MHz, 16-Bit Accurate, Ultra-Low Distortion Op Amps

General Description

The MAX4434/MAX4435 single and MAX4436/MAX4437 dual operational amplifiers feature wide bandwidth, 16-bit settling time in 23ns, and low-noise/low-distortion operation. The MAX4434/MAX4436 are compensated for unity-gain stability and have a small-signal -3dB bandwidth of 150MHz. The MAX4435/MAX4437 are compensated for closed-loop gains of +5 or greater and have a small-signal, -3dB bandwidth of 150MHz.

The MAX4434-MAX4437 op amps require only 15mA of supply current per amplifier while achieving 115dB open-loop gain. Voltage noise density is a low $2.2\text{nV}/\sqrt{\text{Hz}}$ and provides 97dB spurious-free dynamic range (SFDR) at 1MHz. These characteristics make these op amps ideal for driving modern, high-speed 14- and 16-bit analog-to-digital converters (ADCs).

These high-speed op amps feature wide-output voltage swings and a high-current output drive up to 65mA. Using a voltage feedback architecture, the MAX4434-MAX4437 meet the requirements of many applications that previously depended on current feedback amplifiers.

The MAX4434/MAX4435 are available in space-saving 5-pin SOT23 packages and the MAX4436/MAX4437 are available in 8-pin $\mu\text{MAX}^{\text{®}}$ packages.

Applications

- High-Speed 14- and 16-Bit ADC Preamplifiers
- Low-Noise Preamplifiers
- IF/RF Amplifiers
- Low-Distortion Active Filters
- High-Performance Receivers
- Precision Instrumentation

μMAX is a registered trademark of Maxim Integrated Products, Inc.

Pin Configurations

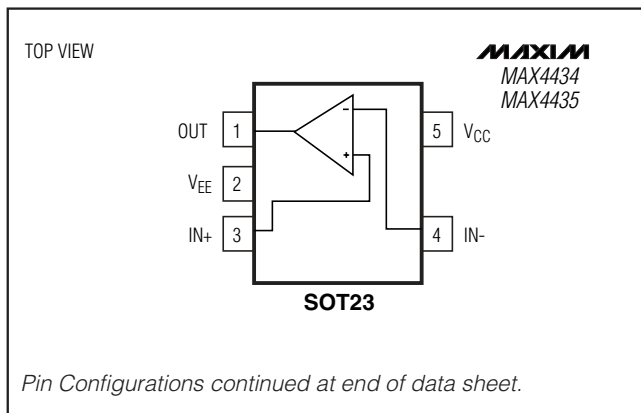

Features

- ◆ 16-Bit Accurate Settling in 23ns (MAX4435/MAX4437)
- ◆ 97dB SFDR at 1MHz, 4Vp-p Output
- ◆ $2.2\text{nV}/\sqrt{\text{Hz}}$ Input Voltage Noise Density
- ◆ 100dB (min) Open-Loop Gain
- ◆ 388V/ μs Slew Rate (MAX4435/MAX4437)
- ◆ 65mA High Output Drive
- ◆ Available in Space-Saving Packages
 - 5-Pin SOT23 (MAX4434/MAX4435)
 - 8-Pin μMAX (MAX4436/MAX4437)

Ordering Information

PART	TEMP RANGE	PIN-PACKAGE
MAX4434EUK-T	-40°C to +85°C	5 SOT23
MAX4434ESA	-40°C to +85°C	8 SO
MAX4434EUK/V+T	-40°C to +85°C	5 SOT23
MAX4435EUK-T	-40°C to +85°C	5 SOT23
MAX4435ESA	-40°C to +85°C	8 SO
MAX4436EUA	-40°C to +85°C	8 μMAX
MAX4436ESA	-40°C to +85°C	8 SO
MAX4437EUA	-40°C to +85°C	8 μMAX
MAX4437ESA	-40°C to +85°C	8 SO

+Denotes a lead(Pb)-free/RoHS-compliant package.

Selector Guide appears at end of data sheet.

Typical Operating Circuit

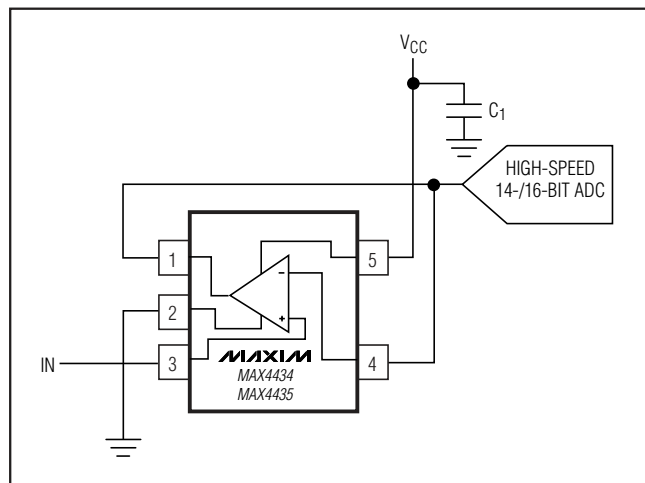

Single-Supply, 150MHz, 16-Bit Accurate, Ultra-Low Distortion Op Amps

ABSOLUTE MAXIMUM RATINGS

Supply Voltage ($V_{CC} - V_{EE}$)	+6V	8-Pin SO (derate 5.88mW/°C above +70°C)	471mW
Differential Input Voltage	+2V	8-Pin μ MAX (derate 4.5mW/°C above +70°C)	330mW
Input Voltage Range	($V_{CC} + 0.3V$) to ($V_{EE} - 0.3V$)	Operating Temperature Range	-40°C to +85°C
Current into Any Input Pin	$\pm 25mA$	Junction Temperature	+150°C
Output Short-Circuit Duration to V_{CC} or V_{EE}	(Note 1)	Storage Temperature Range	-65°C to +150°C
Continuous Power Dissipation ($T_A = +70^\circ C$)		Lead Temperature (soldering, 10s)	+300°C
5-Pin SOT23 (derate 7.1mW/°C above +70°C)	571mW		

Note 1: The MAX4434–MAX4437 are not protected for output short-circuit conditions.

Stresses beyond those listed under "Absolute Maximum Ratings" may cause permanent damage to the device. These are stress ratings only, and functional operation of the device at these or any other conditions beyond those indicated in the operational sections of the specifications is not implied. Exposure to absolute maximum rating conditions for extended periods may affect device reliability.

DC ELECTRICAL CHARACTERISTICS

($V_{CC} = +5V$, $V_{EE} = 0$, $R_L = \infty$ to $V_{CC}/2$, $T_A = T_{MIN}$ to T_{MAX} , unless otherwise noted. Typical values are at $T_A = +25^\circ C$.) (Note 2)

PARAMETER	SYMBOL	CONDITIONS	MIN	TYP	MAX	UNITS
Input Common-Mode Voltage Range	V_{CM}	Guaranteed by CMRR test	V_{EE}		$V_{CC} - 1$	V
Input Offset Voltage	V_{OS}			1	3.5	mV
Input Offset Voltage Temperature Coefficient	TCV_{OS}			4		$\mu V/^\circ C$
Input Offset Voltage Matching		MAX4436/MAX4437		0.25		mV
Input Bias Current	I_B			14	22	μA
Input Offset Current	I_{OS}			1	5	μA
Input Resistance	R_{IN}	Differential Mode $-10mV \leq V_{IN} \leq +10mV$		1		k Ω
		Common Mode $0 \leq V_{CM} \leq (V_{CC} - 1V)$		1.7		M Ω
Common-Mode Rejection Ratio	CMRR	$V_{EE} \leq V_{CM} \leq (V_{CC} - 1V)$	75	100		dB
Open-Loop Gain	A_{VOL}	$(V_{EE} + 0.25) \leq V_{OUT} \leq (V_{CC} - 0.25)$, $R_L = 10k\Omega$	100	115		dB
		$(V_{EE} + 0.5) \leq V_{OUT} \leq (V_{CC} - 0.5)$, $R_L = 500\Omega$	96	110		
Output Voltage Swing	V_{OUT}	$R_L = 10k\Omega$	$V_{CC} - V_{OH}$	65	200	mV
			$V_{OL} - V_{EE}$	15	70	
Output Current	I_{OUT}	$R_L = 20\Omega$ to Ground	Sinking	40	65	mA
			Sourcing	35	60	
Output Short-Circuit Current	I_{SC}	Sinking or sourcing		± 70		mA
DC Power-Supply Rejection Ratio	PSRR	$V_{CC} = +4.5V$ to $+5.5V$	85	110		dB
Operating Supply Voltage	V_S	Guaranteed by PSRR test	+4.5		+5.5	V
Quiescent Supply Current (Per Amplifier)	I_S			15	18	mA

Note 2: All devices are 100% production tested at +25°C. Specifications over temperature limits are guaranteed by design.

Single-Supply, 150MHz, 16-Bit Accurate, Ultra-Low Distortion Op Amps

MAX4434-MAX4437

AC ELECTRICAL CHARACTERISTICS

($V_{CC} = +5V$, $V_{EE} = 0$, $V_{CM} = V_{CC}/2$, $R_L = 500\Omega$, $A_{VCL} = +1$, and $T_A = +25^\circ C$, unless otherwise noted.)

PARAMETER	SYMBOL	CONDITIONS	MIN	TYP	MAX	UNITS
Small-Signal -3dB Bandwidth	BW _{SS}	V _{OUT} = 20mVp-p MAX4434/MAX4436		150		MHz
		V _{OUT} = 20mVp-p MAX4435/MAX4437 (A _{VCL} = +5)		150		
Large-Signal -3dB Bandwidth	BW _{LS}	V _{OUT} = 2Vp-p MAX4434/MAX4436		28		MHz
		V _{OUT} = 4Vp-p MAX4435/MAX4437 (A _{VCL} = +5)		25		
Small-Signal 0.1dB Gain Flatness	BW _{0.1dBSS}	V _{OUT} = 20mVp-p MAX4434/MAX4436		80		MHz
		V _{OUT} = 20mVp-p MAX4435/MAX4437 (A _{VCL} = +5)		80		
Large-Signal 0.1dB Gain Flatness	BW _{0.1dBLS}	V _{OUT} = 2Vp-p MAX4434/MAX4436		15		MHz
		V _{OUT} = 4Vp-p MAX4435/MAX4437 (A _{VCL} = +5)		20		
Slew Rate	SR	V _{OUT} = 2V step MAX4434/MAX4436		133		V/ μ s
		V _{OUT} = 4V step MAX4435/MAX4437 (A _{VCL} = +5)		388		
Rise/Fall Time	t _R , t _F	V _{OUT} = 2V step MAX4434/MAX4436		17		ns
		V _{OUT} = 4V step MAX4435/MAX4437 (A _{VCL} = +5)		10		
Settling Time to 16-Bit (0.0015%)	t _S 0.0015%	V _{OUT} = 1.5V to 3.5V step MAX4434/MAX4436		35		ns
		V _{OUT} = 1.5V to 3.5V step MAX4435/MAX4437 (A _{VCL} = +5)		23		
		V _{OUT} = 1V to 4V step MAX4434/MAX4436		42		
Output "Glitch" Settling to 16-Bit (0.0015%)		5pF load, C _L charged from 1V to 4V		41		ns
Output Overload Recovery Time		50% overdrive, settling to 10% accuracy		100		ns
AC Common-Mode Rejection Ratio	CMRR	f _C = 100kHz		-92		dB

Single-Supply, 150MHz, 16-Bit Accurate, Ultra-Low Distortion Op Amps

AC ELECTRICAL CHARACTERISTICS (continued)

($V_{CC} = +5V$, $V_{EE} = 0$, $V_{CM} = V_{CC}/2$, $R_L = 500\Omega$, $A_{vCL} = +1$, and $T_A = +25^\circ C$, unless otherwise noted.)

PARAMETER	SYMBOL	CONDITIONS	MIN	TYP	MAX	UNITS
AC Power-Supply Rejection Ratio	PSRR	$f_C = 100kHz$		-101		dB
Spurious-Free Dynamic Range	SFDR	$V_{OUT} = 2V_{p-p}$ centered at $V_{CC}/2$	$f_C = 100kHz$	-97		dBc
			$f_C = 1MHz$	-98		
		$V_{OUT} = 3V_{p-p}$ centered at $V_{CC}/2$	$f_C = 100kHz$	-130		
			$f_C = 1MHz$	-99		
		$V_{OUT} = 4V_{p-p}$ centered at $V_{CC}/2$	$f_C = 100kHz$	-112		
			$f_C = 1MHz$	-97		
Input Noise Voltage Density	e_n	$f_C = 100kHz$		2.2		nV/\sqrt{Hz}
Input Noise Current Density	i_n	$f_C = 100kHz$		2.0		pA/\sqrt{Hz}
Input Capacitance	C_{IN}			2.3		pF
Maximum Capacitive Load Without Sustained Oscillations				30		pF
Output Impedance	Z_{OUT}	$f_C = 1MHz$		0.05		Ω
Crosstalk		$f_C = 1MHz$, MAX4436/MAX4437		-80		dB

Typical Operating Characteristics

($V_{CC} = +5V$, $V_{EE} = 0$, $R_L = 500\Omega$, $C_L = 0$, $T_A = +25^\circ C$, unless otherwise noted.)

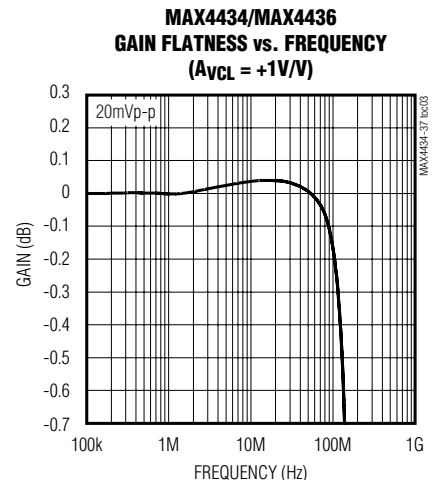
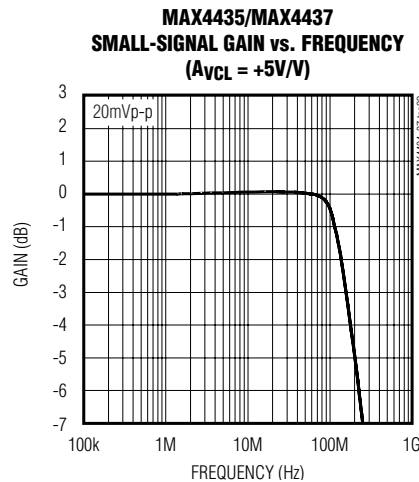
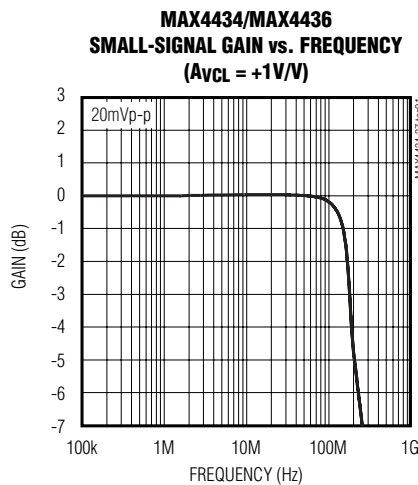

Single-Supply, 150MHz, 16-Bit Accurate, Ultra-Low Distortion Op Amps

Typical Operating Characteristics (continued)

($V_{CC} = +5V$, $V_{EE} = 0$, $R_L = 500\Omega$, $C_L = 0$, $T_A = +25^\circ C$, unless otherwise noted.)

MAX4434-MAX4437

MAX4434/MAX4436
GAIN FLATNESS vs. FREQUENCY
($A_{VCL} = +1V/V$)

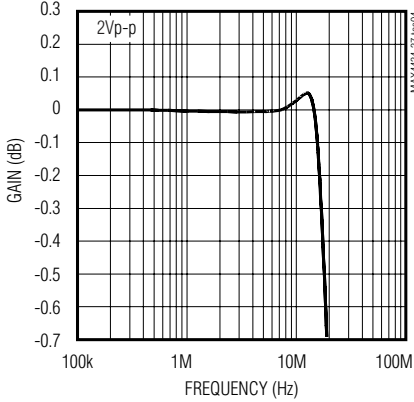

MAX4435/MAX4437
GAIN FLATNESS vs. FREQUENCY
($A_{VCL} = +5V/V$)

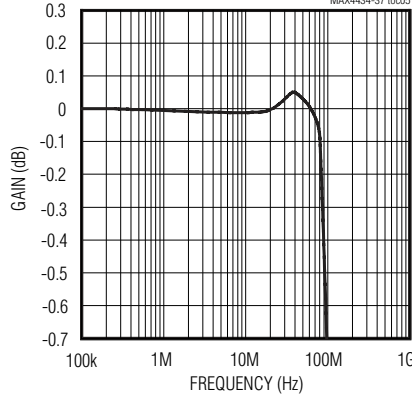

MAX4435/MAX4437
GAIN FLATNESS vs. FREQUENCY
($A_{VCL} = +5V/V$)

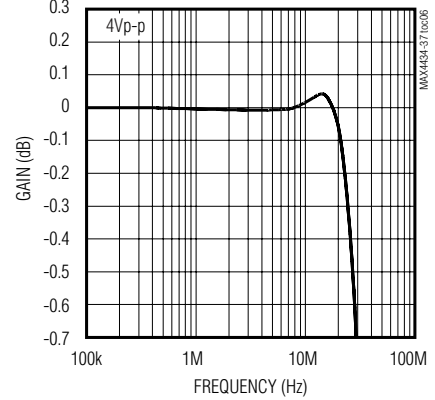

MAX4434/MAX4436
LARGE-SIGNAL GAIN vs. FREQUENCY
($A_{VCL} = +1V/V$)

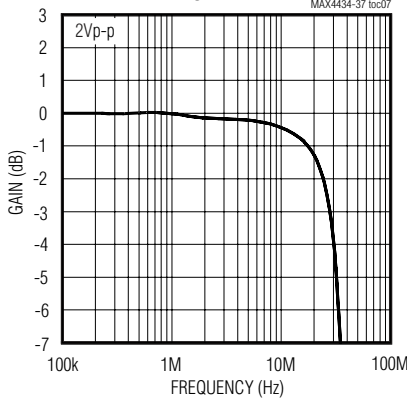

MAX4435/MAX4437
LARGE-SIGNAL GAIN vs. FREQUENCY
($A_{VCL} = +5V/V$)

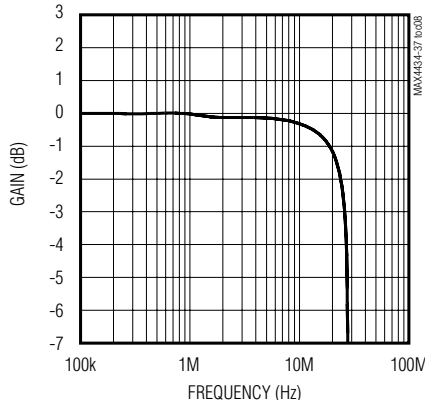

MAX4434/MAX4436
SMALL-SIGNAL PULSE RESPONSE

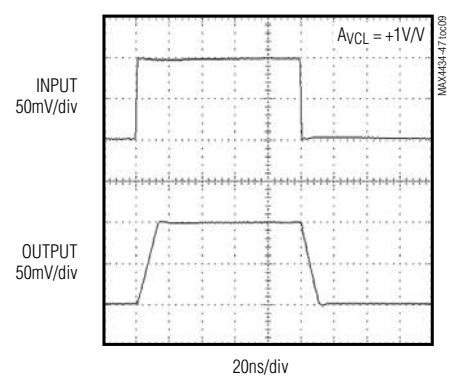

MAX4435/MAX4437
SMALL-SIGNAL PULSE RESPONSE

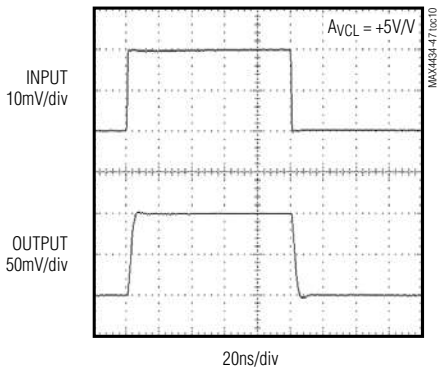

MAX4434/MAX4436
LARGE-SIGNAL PULSE RESPONSE

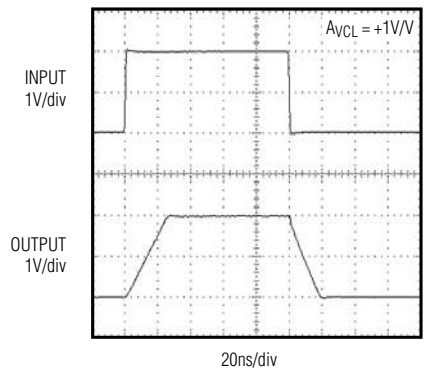

MAX4435/MAX4437
LARGE-SIGNAL PULSE RESPONSE

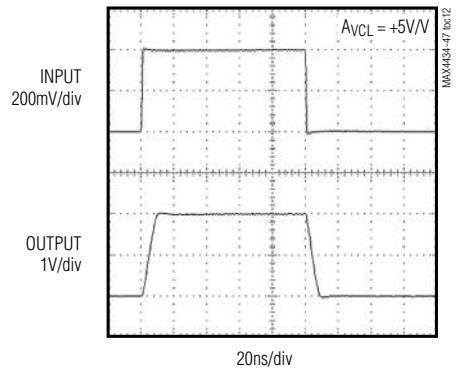

Single-Supply, 150MHz, 16-Bit Accurate, Ultra-Low Distortion Op Amps

Typical Operating Characteristics (continued)

($V_{CC} = +5V$, $V_{EE} = 0$, $R_L = 500\Omega$, $C_L = 0$, $T_A = +25^\circ C$, unless otherwise noted.)

**MAX4434/MAX4436
SMALL-SIGNAL PULSE RESPONSE**

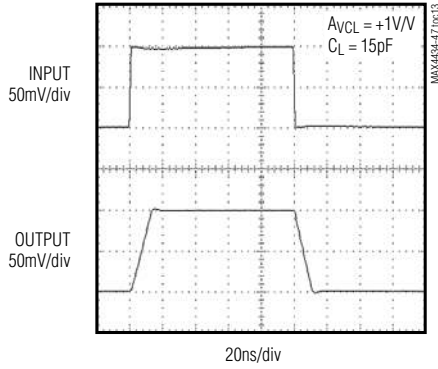

**MAX4435/MAX4437
SMALL-SIGNAL PULSE RESPONSE**

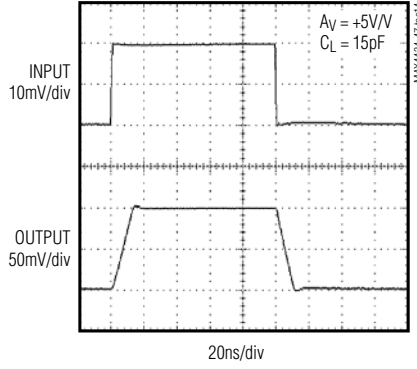

**MAX4434/MAX4436
LARGE-SIGNAL PULSE RESPONSE**

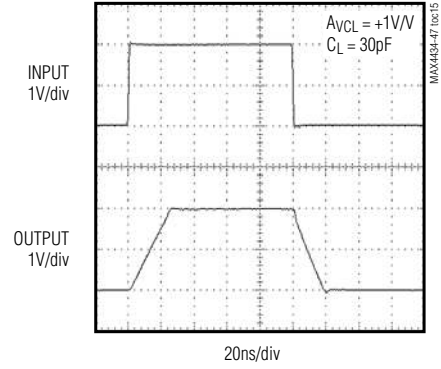

**MAX4435/MAX4437
LARGE-SIGNAL PULSE RESPONSE**

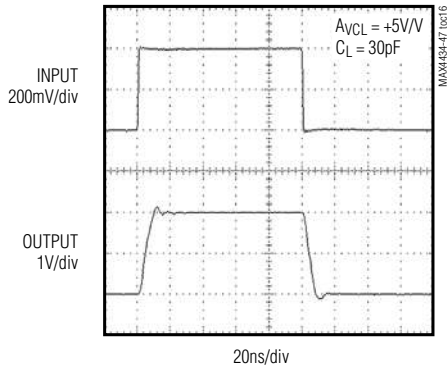

**POWER-SUPPLY REJECTION RATIO
vs. FREQUENCY**

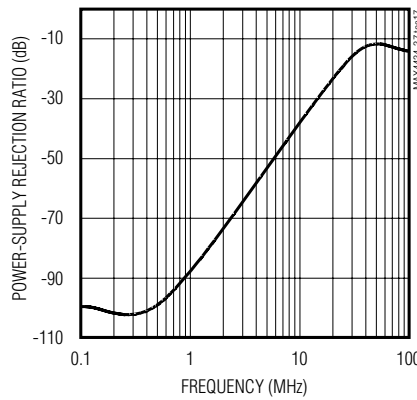

**COMMON-MODE REJECTION RATIO
vs. FREQUENCY**

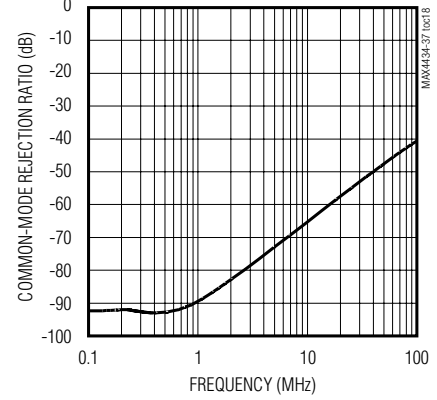

**OUTPUT ISOLATION RESISTANCE
vs. CAPACITIVE LOAD**

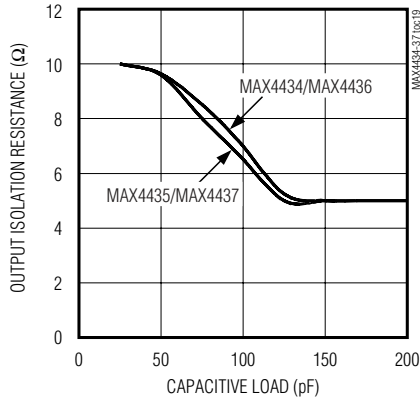

**CLOSED-LOOP OUTPUT IMPEDANCE
vs. FREQUENCY**

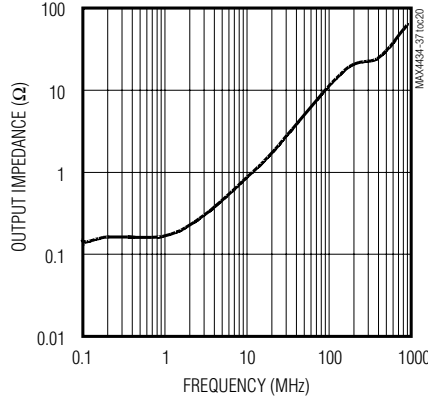

GAIN AND PHASE vs. FREQUENCY

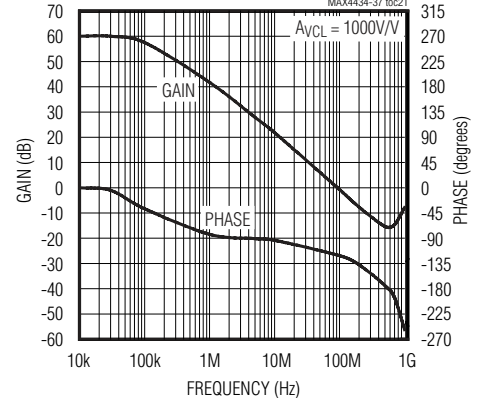

Single-Supply, 150MHz, 16-Bit Accurate, Ultra-Low Distortion Op Amps

MAX4434-MAX4437

Typical Operating Characteristics (continued)

($V_{CC} = +5V$, $V_{EE} = 0$, $R_L = 500\Omega$, $C_L = 0$, $T_A = +25^\circ C$, unless otherwise noted.)

HARMONIC DISTORTION vs. FREQUENCY

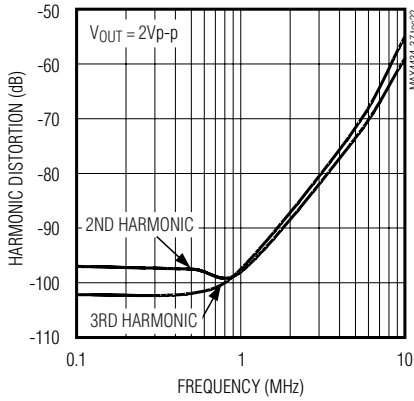

HARMONIC DISTORTION vs. OUTPUT SWING

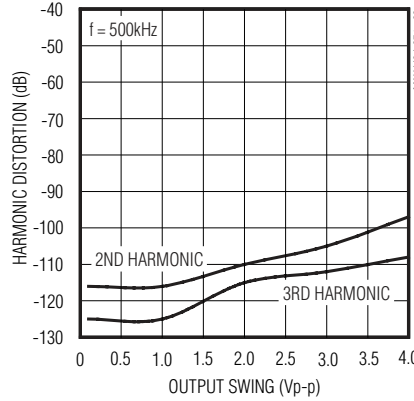

HARMONIC DISTORTION vs. RESISTIVE LOAD

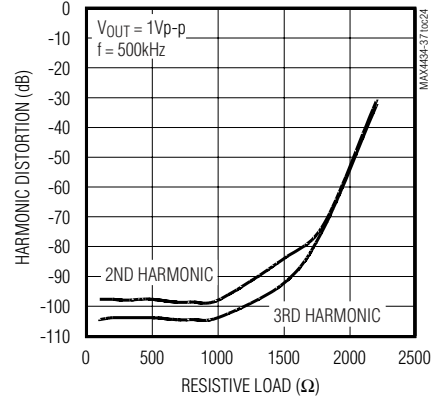

INPUT VOLTAGE NOISE vs. FREQUENCY

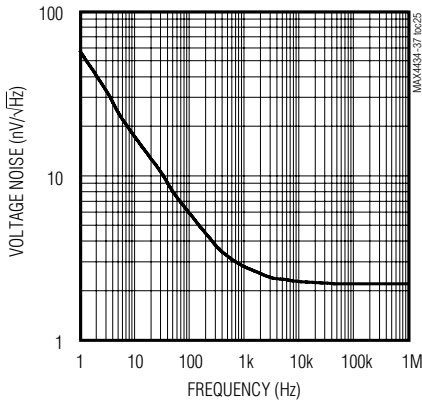

INPUT CURRENT NOISE DENSITY vs. FREQUENCY

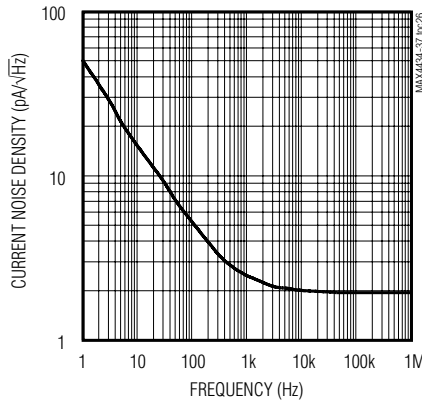

MAX4436/MAX4437 CROSSTALK vs. FREQUENCY

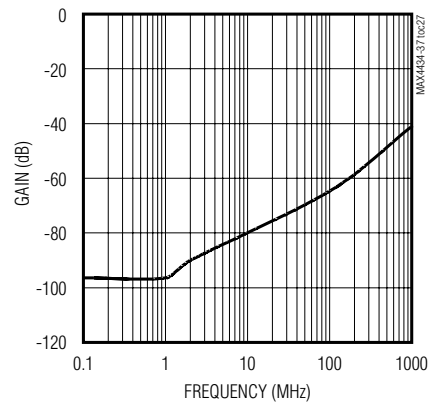

QUIESCENT CURRENT PER AMPLIFIER vs. TEMPERATURE

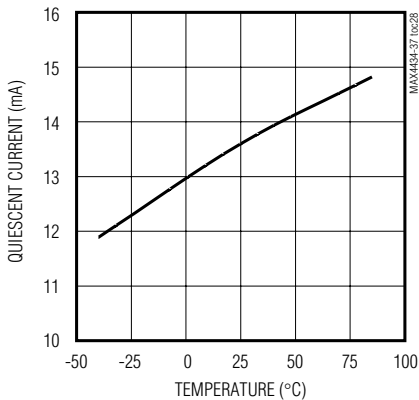

BIAS CURRENT vs. TEMPERATURE

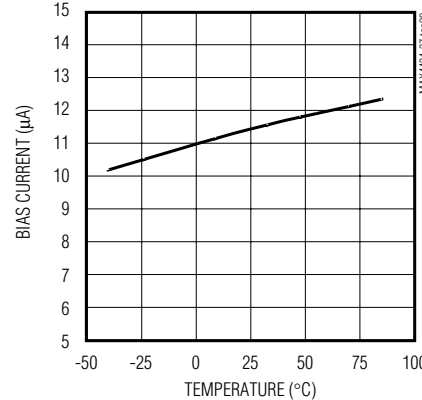

OFFSET VOLTAGE vs. TEMPERATURE

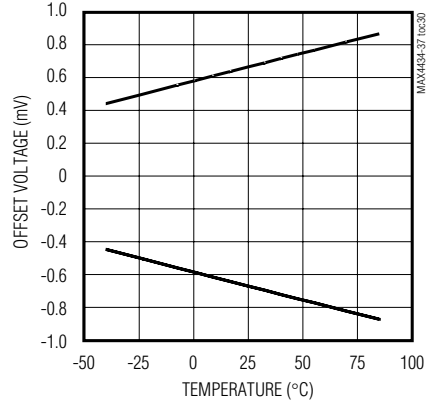

Single-Supply, 150MHz, 16-Bit Accurate, Ultra-Low Distortion Op Amps

Typical Operating Characteristics (continued)

($V_{CC} = +5V$, $V_{EE} = 0$, $R_L = 500\Omega$, $C_L = 0$, $T_A = +25^\circ C$, unless otherwise noted.)

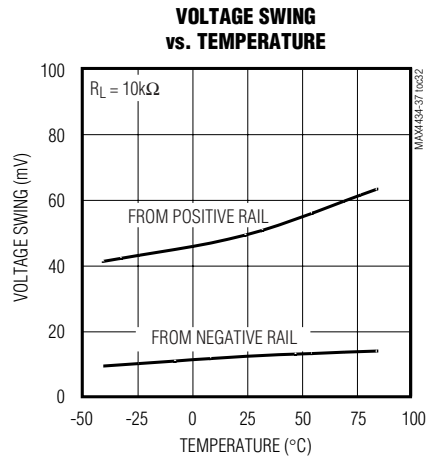
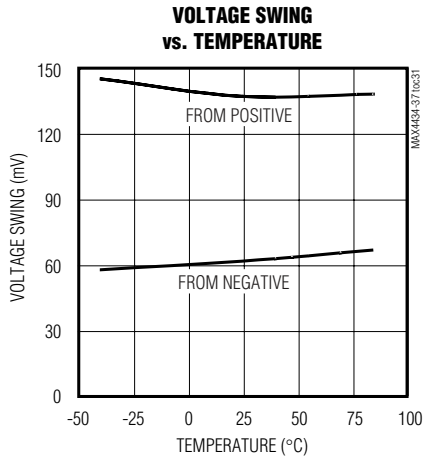

Pin Description

PIN		NAME	FUNCTION
MAX4434/MAX4435			
SOT23	SO		
1	6	OUT	Output
2	4	V_{EE}	Ground
3	3	IN+	Noninverting Input
4	2	IN-	Inverting Input
5	7	V_{CC}	Positive Power Supply
—	1, 5, 8	N.C.	No Connection. Not internally connected.

PIN		NAME	FUNCTION
MAX4436/MAX4437			
SO/ μ MAX			
1		OUTA	Amplifier A Output
2		INA-	Amplifier A Inverting Input
3		INA+	Amplifier A Noninverting Input
4		V_{EE}	Ground
5		INB+	Amplifier A Noninverting Input
6		INB-	Amplifier A Inverting Input
7		OUTB	Amplifier A Output
8		V_{CC}	Positive Power Supply

Single-Supply, 150MHz, 16-Bit Accurate, Ultra-Low Distortion Op Amps

Detailed Description

The MAX4434–MAX4437 are wide-bandwidth, ultra-low-distortion, voltage-feedback amplifiers. The MAX4434/MAX4436 are internally compensated for unity gain. The MAX4435/MAX4437 are internally compensated for gains of +5V/V or greater.

These amplifiers have ultra-fast 35ns (MAX4434/MAX4436) 16-bit settling times, -97dB SFDR at 1MHz, and 4Vp-p output swing with minimum 115dB open-loop gain.

High-Speed ADC Input Driver Application

The MAX4434–MAX4437 op amps are ideal for driving high-speed 14- to 16-bit ADCs. In most cases, these ADCs operate with a charge balance scheme, with capacitive loads internally switched on and off from the input. The driver used must withstand these changing capacitive loads while holding the signal amplitude stability consistent with the ADC's resolution and, at the same time, have a frequency response compatible with the sampling speed of the ADC (Figure 1).

Inverting and Noninverting Configurations

The circuits typically used for the inverting and non-inverting configurations of the MAX4434–MAX4437 are shown in Figures 2a and 2b. The minimum unconditionally stable gain values are 1 for the MAX4434/MAX4436

and 5 for the MAX4435/MAX4437. Use care in selecting the value for the resistor marked R_S in both circuits. From dynamic stability considerations (based on the part's frequency response and the input capacitance of the MAX4434–MAX4437), the maximum recommended value for R_S is 500 Ω . In general, lower R_S values will yield a higher bandwidth and better dynamic stability, at the cost of higher power consumption, higher power dissipation in the IC, and reduced output drive availability. For a minimum R_S value, take into consideration that the current indicated as I_F is supplied by the output stage and must be discounted from the maximum output current to calculate the maximum current available to the load. I_F can be found using the following equation:

$$I_F = V_{IN(MAX)} / R_S$$

If DC thermal stability is an important design concern, the Thevenin resistance seen by both inputs at DC must be balanced. This includes the resistance of the signal source and termination resistors if the amplifier signal input is fed from a transmission line. The capacitance associated with the feedback resistors must also be considered as a possible limitation to the available bandwidth or to the dynamic stability. Only resistors with small parallel capacitance specifications should be considered.

Applications Information

Layout and Power-Supply Bypassing

The MAX4434–MAX4437 have wide bandwidth and consequently require careful board layout. To realize the full AC performance of these high-speed amplifiers, pay careful attention to power-supply bypassing and board layout. The PC board should have a large low-impedance ground plane that is as free of voids as possible. Do not use commercial breadboards. Keep signal lines as short and straight as possible. Observe high-frequency bypassing techniques to maintain the amplifier's accuracy and stability. In general, use sur-

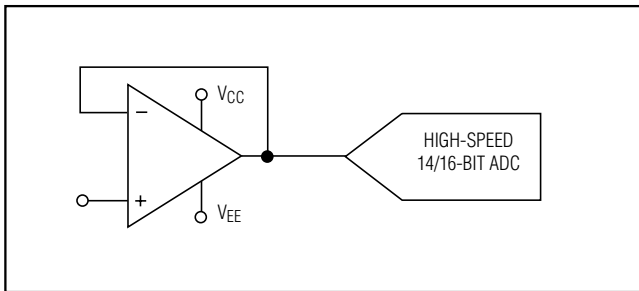

Figure 1. Typical Application Circuit

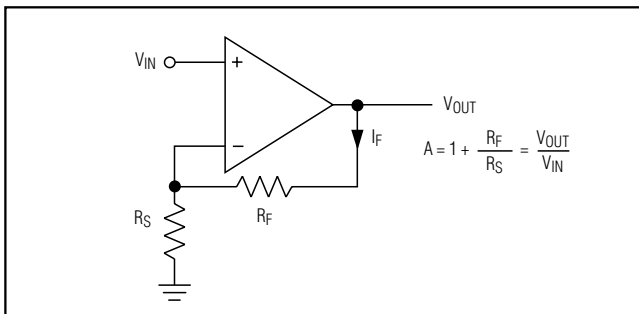

Figure 2a. Noninverting Configuration

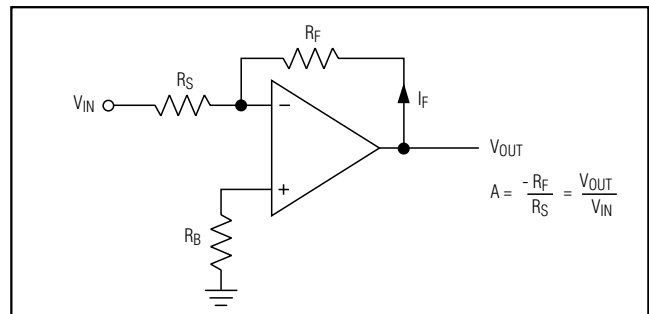

Figure 2b. Inverting Configuration

Single-Supply, 150MHz, 16-Bit Accurate, Ultra-Low Distortion Op Amps

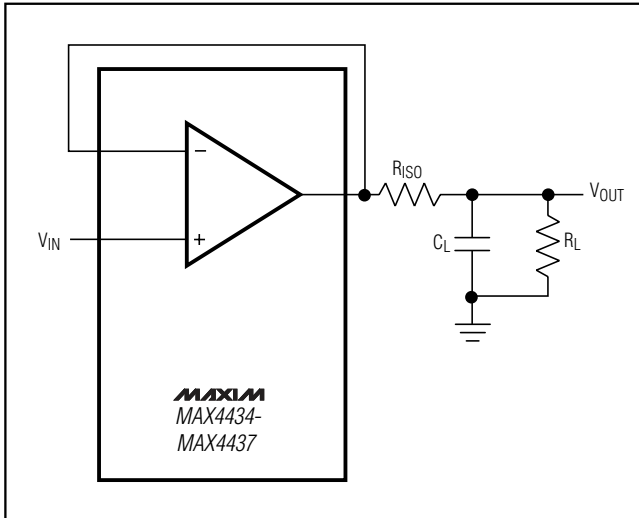

Figure 3. Capacitive-Load Driving Circuit

face-mount components since they have shorter bodies and lower parasitic reactance. This will result in improved performance over through-hole components. The bypass capacitors should include 1nF and/or 0.1μF surface-mount ceramic capacitors between VCC and the ground plane, located as close to the package as possible. Place a 10μF tantalum capacitor at the power supply's point of entry to the PC board to ensure the integrity of the incoming supplies. Input termination resistors and output back-termination resistors, if used, should be surface-mount types and should be placed as close to the IC pins as possible.

Driving Capacitive Loads

The MAX4434-MAX4437 can drive capacitive loads. However, excessive capacitive loads may cause ringing or instability at the output as phase margin is reduced. Adding a small isolation resistor in series with the output capacitive load helps reduce the ringing but slightly increases gain error (see *Typical Operating Characteristics* and Figure 3).

Selector Guide

PART	AMPS	MIN GAIN STABLE (V/V)	BW (MHz)	SETTLING TIME TO 0.0015% (ns)
MAX4434	1	+1	150	35
MAX4435	1	+5	150	23
MAX4436	2	+1	150	35
MAX4437	2	+5	150	23

Pin Configurations (continued)

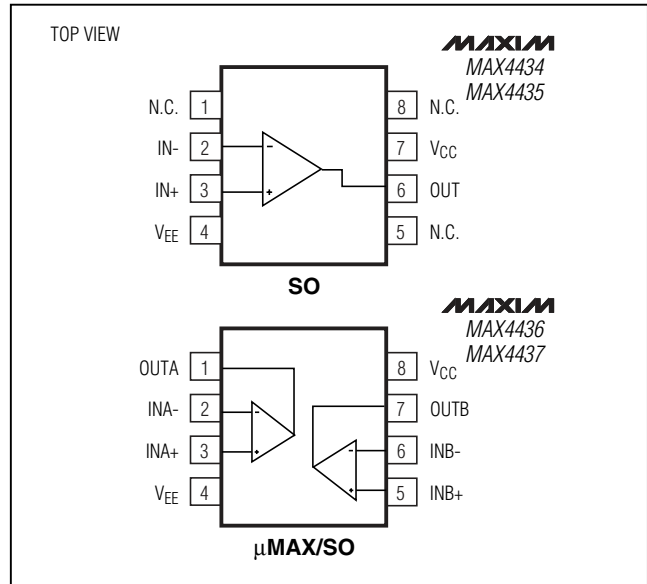

Chip Information

MAX4434/MAX4435 TRANSISTOR COUNT: 141

MAX4436/MAX4437 TRANSISTOR COUNT: 318

Single-Supply, 150MHz, 16-Bit Accurate, Ultra-Low Distortion Op Amps

Package Information

(For the latest package outline information and land patterns, go to www.maxim-ic.com/packages.)

PACKAGE TYPE	PACKAGE CODE	DOCUMENT NO.
5 SOT23	U5-1	21-0057
8 SO	S8-2	21-0036
8 μ MAX	U8-1	21-0041

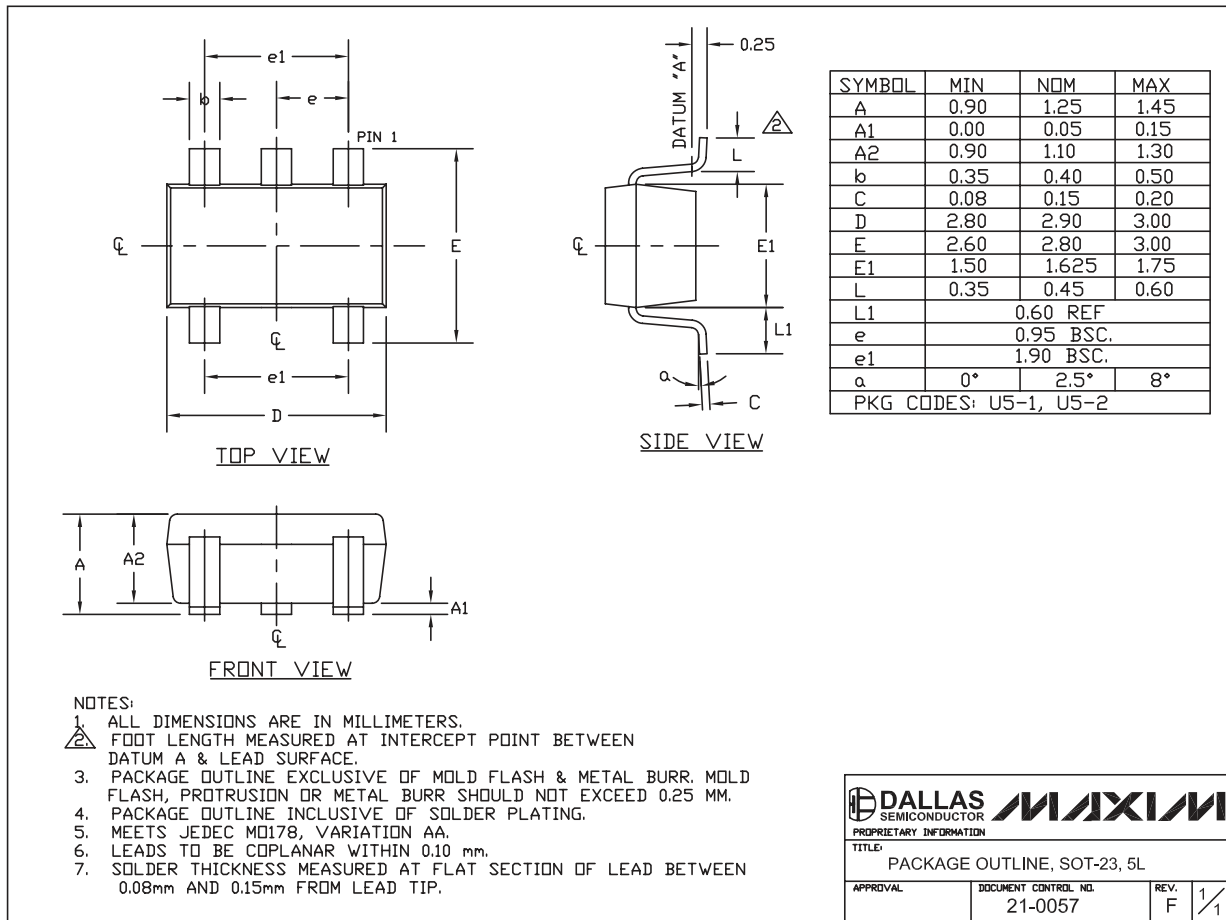

SOT-23 5L EFS

MAX4434-MAX4437

Single-Supply, 150MHz, 16-Bit Accurate, Ultra-Low Distortion Op Amps

Package Information (continued)

(For the latest package outline information and land patterns, go to www.maxim-ic.com/packages.)

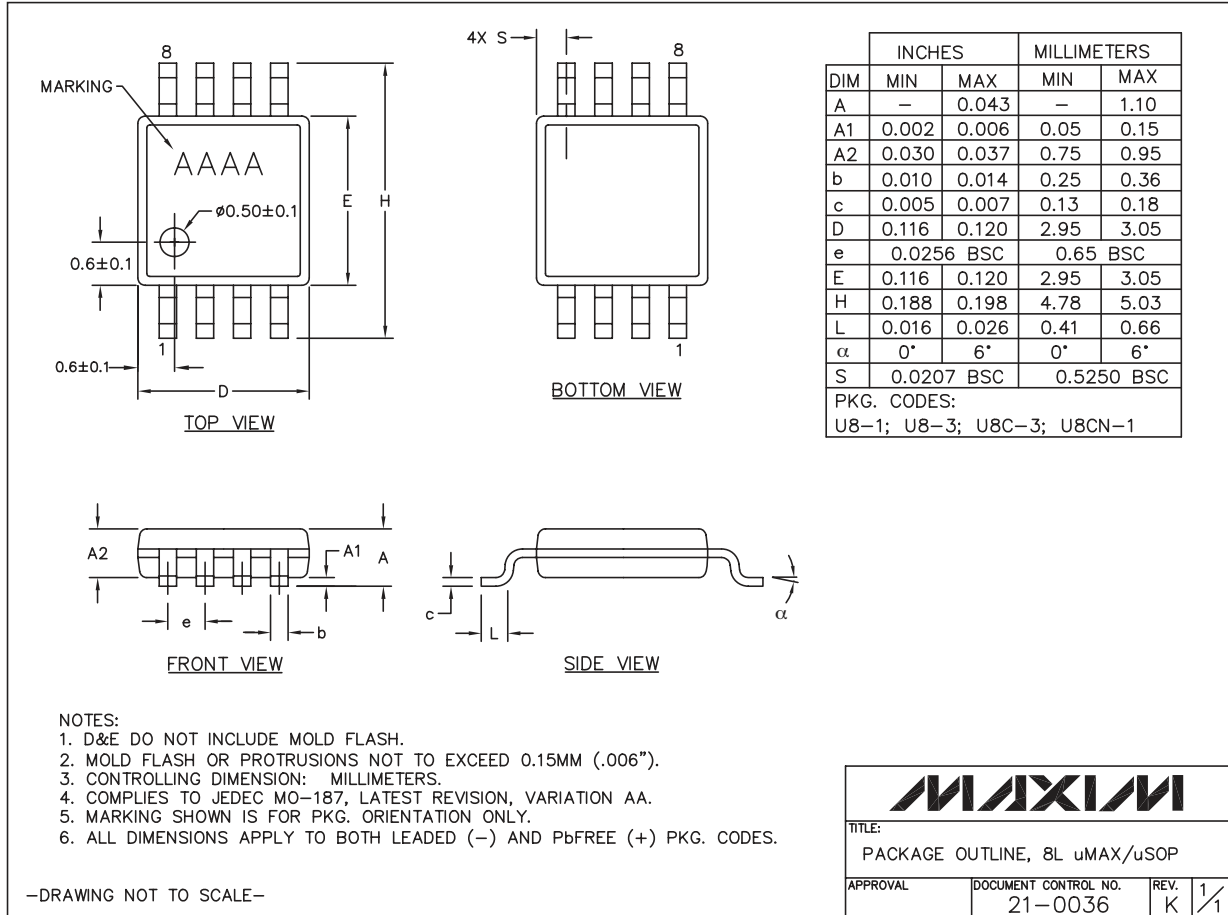

8LUMAXDEPS

Single-Supply, 150MHz, 16-Bit Accurate, Ultra-Low Distortion Op Amps

Package Information (continued)

(For the latest package outline information and land patterns, go to www.maxim-ic.com/packages.)

MAX4434-MAX4437

TOP VIEW

FRONT VIEW

SIDE VIEW

NOTES:

1. D&E DO NOT INCLUDE MOLD FLASH.
2. MOLD FLASH OR PROTRUSIONS NOT TO EXCEED 0.15mm (.006").
3. LEADS TO BE COPLANAR WITHIN 0.10mm (.004").
4. CONTROLLING DIMENSION: MILLIMETERS.
5. MEETS JEDEC MS012.
6. N = NUMBER OF PINS.

DIM	INCHES		MILLIMETERS	
	MIN	MAX	MIN	MAX
A	0.053	0.069	1.35	1.75
A1	0.004	0.010	0.10	0.25
B	0.014	0.019	0.35	0.49
C	0.007	0.010	0.19	0.25
e	0.050 BSC		1.27 BSC	
E	0.150	0.157	3.80	4.00
H	0.228	0.244	5.80	6.20
L	0.016	0.050	0.40	1.27

VARIATIONS:

DIM	INCHES		MILLIMETERS		N	MS012
	MIN	MAX	MIN	MAX		
D	0.189	0.197	4.80	5.00	8	AA
D	0.337	0.344	8.55	8.75	14	AB
D	0.386	0.394	9.80	10.00	16	AC

PROPRIETARY INFORMATION

TITLE: PACKAGE OUTLINE, .150" SOIC

APPROVAL: _____ DOCUMENT CONTROL NO. 21-0041 REV. B 1/1

Single-Supply, 150MHz, 16-Bit Accurate, Ultra-Low Distortion Op Amps

Revision History

REVISION NUMBER	REVISION DATE	DESCRIPTION	PAGES CHANGED
0	10/01	Initial release	—
1	12/08	Added automotive part number	1

Maxim cannot assume responsibility for use of any circuitry other than circuitry entirely embodied in a Maxim product. No circuit patent licenses are implied. Maxim reserves the right to change the circuitry and specifications without notice at any time.

14 _____ **Maxim Integrated Products, 120 San Gabriel Drive, Sunnyvale, CA 94086 408-737-7600**