

PART NUMBER SEE SHEET 2

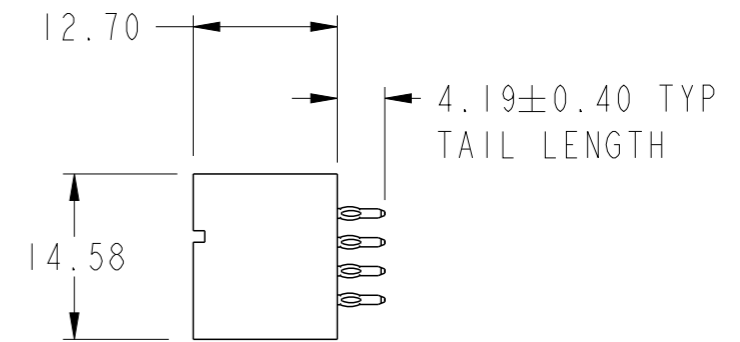

spec ref	*	dr	Xie Bob	2013/10/09	projection	MM	size	A3	scale	3:2
tolerance std	ASME Y14.5	eng	Eddy Zeng	2013/12/03			ecn no		-	
TOLERANCES UNLESS OTHERWISE SPECIFIED		chr	Li-He	2013/12/02			product family		PwrBlade+	rel level
surface	<input checked="" type="checkbox"/> linear <input type="checkbox"/> angular	appr	Pei-Ming Zheng	2013/12/03				cat. no. 2HP + 16S + 2HP VERTICAL PF HEADER		dwg no 10106129-4004001 rev A
ASME Y14.5	linear: 0.X ±0.5, 0.XX ±0.25, 0.XXX ±0.10 angular: 0° ±2°	www.fci.com			Product - Customer Drw			sheet 1 of 3		

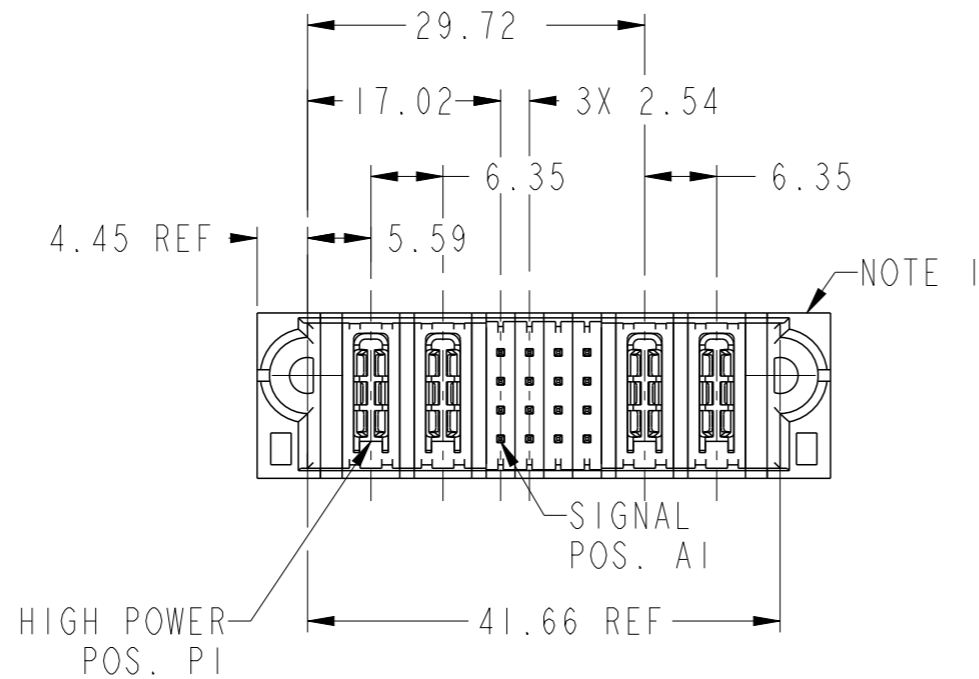
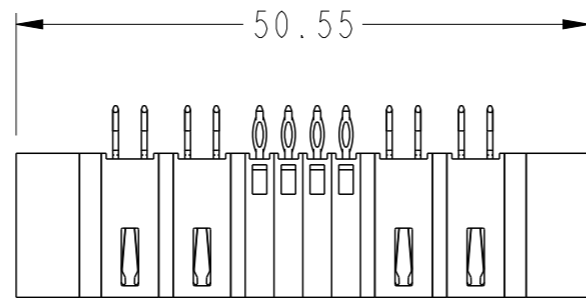
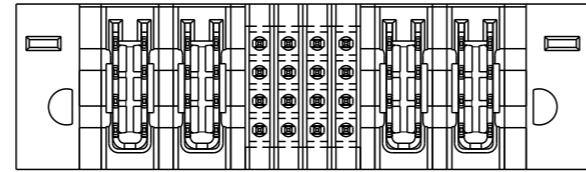

Copyright FCI.

PRODUCT NO. 10106129-4004001LF	ROWS DCBA	HP		SIGNAL				HP		E2
		E1	P1	P2	1	2	3	4	P3	

CODE	DESCRIPTION
G	STD SIGNAL CONTACT'
H4	STD POWER CONTACT'

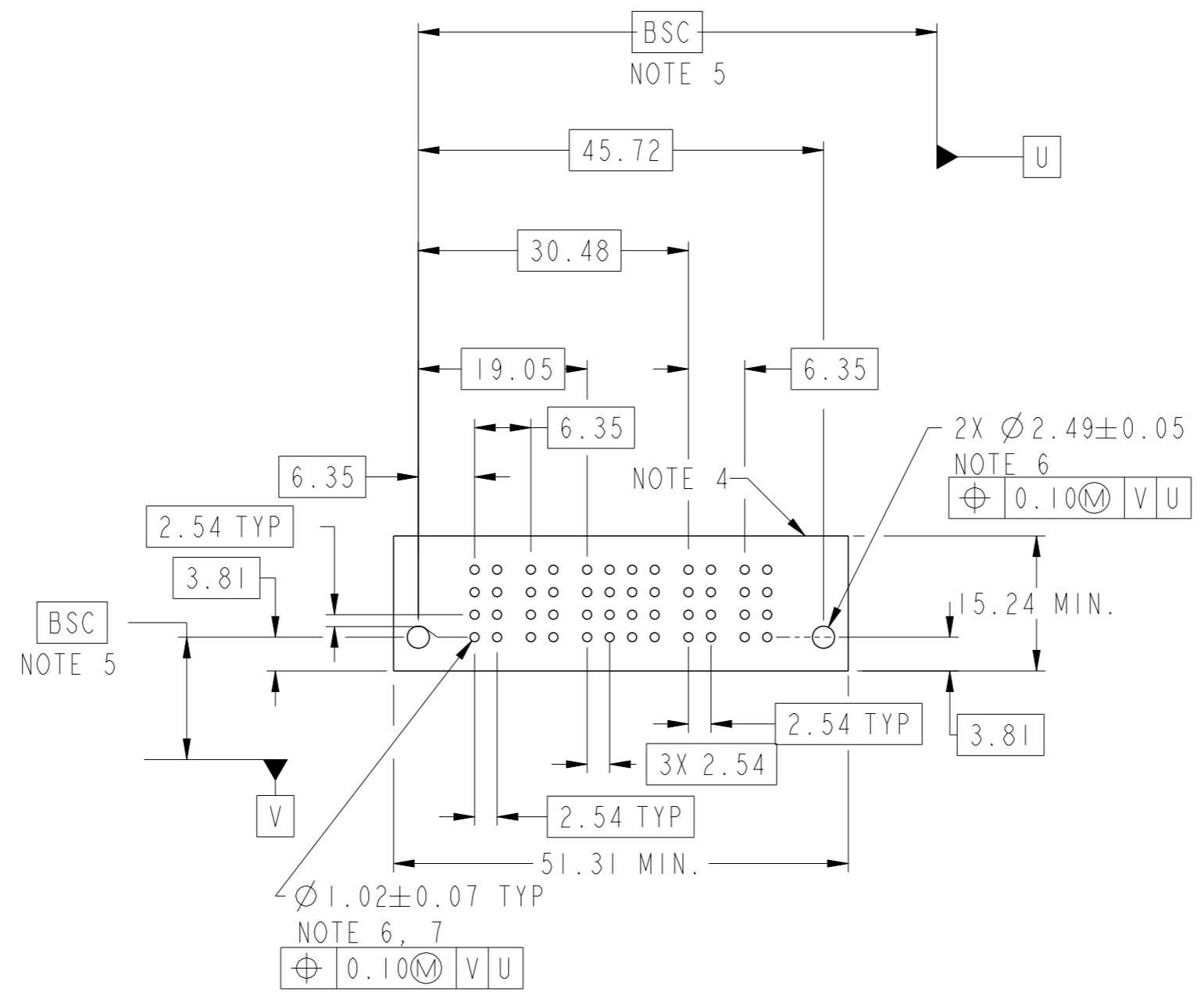

Copyright FCI.

dr	Xie Bob	2013/10/09	projection	MM	size	A3	scale	3:2
eng	Eddy Zeng	2013/12/03			ecn no	-		
chr	Li-He	2013/12/02	product family	PwrBlade+	rel level			
appr	Pei-Ming Zheng	2013/12/03			Released			
		title 2HP + 16S + 2HP VERTICAL PF HEADER			dwg no 10106129-4004001	rev A		
www.fci.com		cat. no.		Product - Customer Drw			sheet 2 of 3	

A

B

C

D

A

B

C



D

NOTES:

- 1) "FCI", PART NUMBER AND DATE CODE TO BE MARKED ON THIS SURFACE.
THE MARK CAN BE OMITTED IF THERE IS NOT ENOUGH SPACE ON THIS SURFACE.
- 2) MATERIALS:
-HOUSING - GLASS FILLED WITH HIGH TEMP THERMOPLASTIC, UL94V-0.
-SIGNAL CONTACT - COPPER ALLOY.
-POWER CONTACT - HIGH CONDUCTIVITY COPPER ALLOY.
- 3) PLATING SPECIFICATION REFER TO FCI 10116351
- 4) DENOTES CONNECTOR KEEP OUT ZONE.
- 5) DATUM AND BASIC DIMENIONS WERE ESTABLISHED BY CUSTOMER.
- 6) ALL HOLE DIAMETERS ARE FINISHED HOLE SIZES.
- 7) 1.15 ± 0.025 MM DRILLED HOLE PLATED WITH 0.00762MM MIN Sn
OVER 0.0254-0.0762MM Cu PLATING TO ACHIEVE A 1.02 ± 0.07 MM HOLE.
- 8) PRODUCT SPECIFICATION REFER TO FCI GS-12-658.
APPLICATION SPECIFICATION REFER TO FCI GS-20-141.
PRODUCT PACKAGED IN TRAYS, REFER TO FCI GS-14-1502.

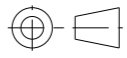
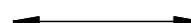

Copyright FCI.

dr	Xie Bob	2013/10/09	projection 	MM 	size	A3	scale	3:2
eng	Eddy Zeng	2013/12/03			ecn no	-		
chr	Li-He	2013/12/02			product family	PwrBlade+	rel level	Released
appr	Pei-Ming Zheng	2013/12/03			 title 2HP + 16S + 2HP VERTICAL PF HEADER		dwg no 10106129-4004001	rev A
www.fci.com		cat. no.	Product - Customer Drw		sheet 3 of 3			