

THIS DRAWING IS UNPUBLISHED. RELEASED FOR PUBLICATION 20  
 © COPYRIGHT 20 BY - ALL RIGHTS RESERVED.

REVISIONS				
P	LTR	DESCRIPTION	DATE	APVD
	E12	REVISED PER ECO-13-016361	19OCT2013	KH MM

1 MATERIALS AND FINISH  
 HOUSING: PA 6-6, UL 94-V0, COLOR: GREEN.  
 CLAMP: BRASS, NICKEL PLATED.  
 CONTACT SPRING : PHOSPHOR BRONZE, TIN PLATED.  
 CLAMPING SCREW: M3, BRASS, NICKEL PLATED.

2. WIRE SIZE RANGE: 12 - 30 AWG

3 NOT CUMULATIVE TOLERANCE.

4 CHARACTERS MARKED IN PERMANENT WHITE COLOR.

5 PARTS SHOWN WITH INTEGRATED KEYING FEATURE LOCATED AS SHOWN.

6 CHARACTERS MARKED IN PERMANENT BLACK COLOR.

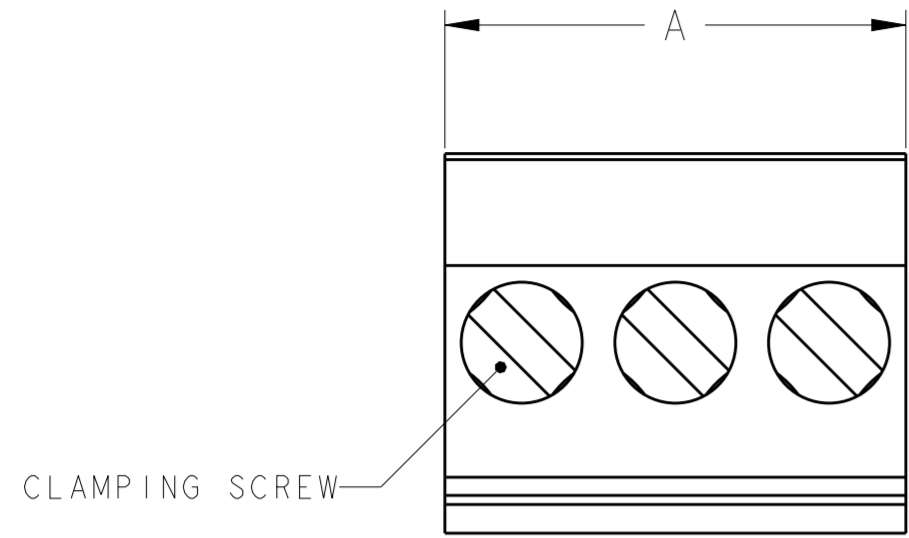

CLAMPING SCREW

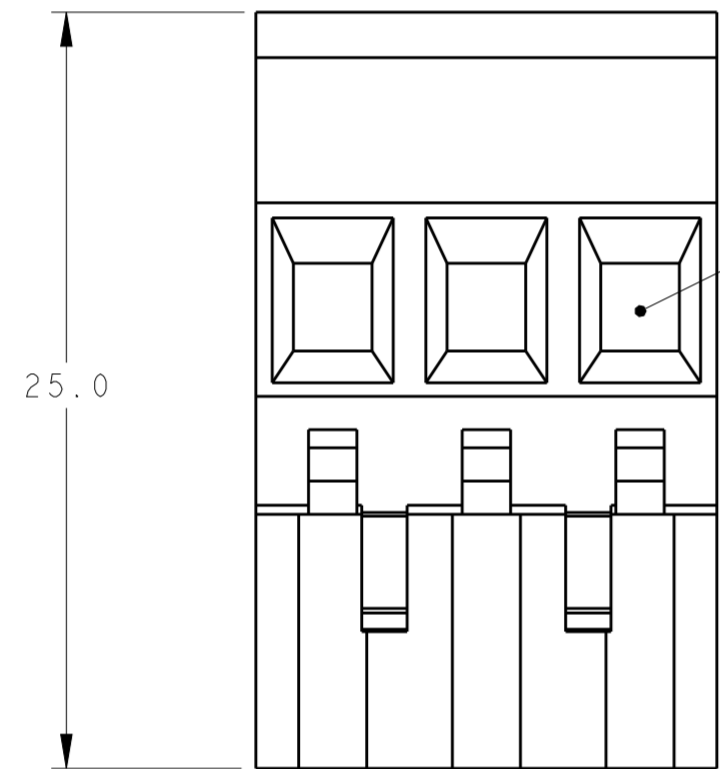

WIRE ENTRY

RETENTION LATCH

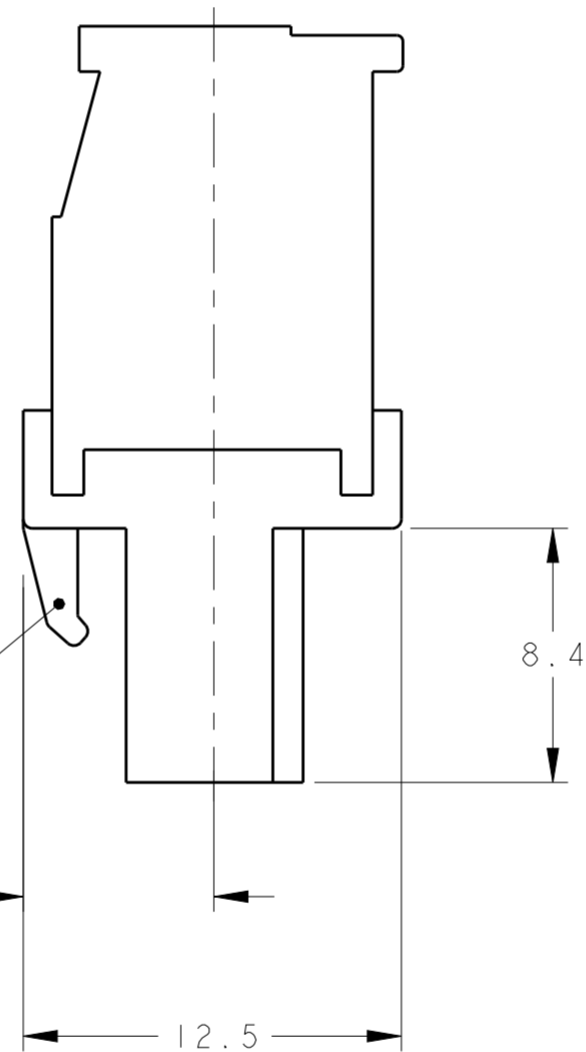

POLARIZATION KEY SLOT

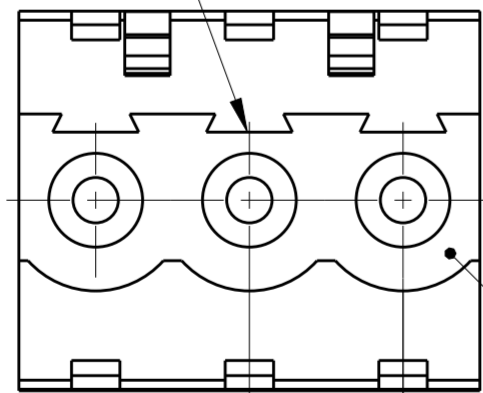

MATING FACE

2.54 REF TYP

3  
 5.08±0.05 TYP

SEE DETAIL A-D	106.68	21	4-284047-1
SEE DETAIL A-C	106.68	21	4-284047-0
SEE DETAIL A-B	76.20	15	3-284047-9
SEE DETAIL A-A	76.20	15	3-284047-8
SEE DETAIL Z	121.92	24	3-284047-7
5 SEE DETAIL X	81.28	16	3-284047-6
5 SEE DETAIL W	81.28	16	3-284047-5
5 SEE DETAIL V	60.96	12	3-284047-4
5 SEE DETAIL U	60.96	12	3-284047-3
5 SEE DETAIL T	121.92	24	3-284047-2
5 SEE DETAIL S	121.92	24	3-284047-1
5 SEE DETAIL R	91.44	18	3-284047-0
5 SEE DETAIL P	91.44	18	2-284047-9
SEE DETAIL N	24.40	5	2-284047-8
SEE DETAIL M	20.32	4	2-284047-7
SEE DETAIL L	10.16	2	2-284047-6
-	127.00	25	2-284047-5
-	121.92	24	2-284047-4
-	116.84	23	2-284047-3
-	111.76	22	2-284047-2
-	106.68	21	2-284047-1
-	101.60	20	2-284047-0
-	96.52	19	1-284047-9
-	91.44	18	1-284047-8
-	86.36	17	1-284047-7
-	81.28	16	1-284047-6
-	76.20	15	1-284047-5
-	71.12	14	1-284047-4
-	66.04	13	1-284047-3
-	60.96	12	1-284047-2
-	55.88	11	1-284047-1
-	50.80	10	1-284047-0
-	45.72	9	284047-9
-	40.64	8	284047-8
-	35.56	7	284047-7
-	30.48	6	284047-6
-	25.40	5	284047-5
-	20.32	4	284047-4
-	15.24	3	284047-3
-	10.16	2	284047-2

MARKING A NO OF POSN PART NUMBER

THIS DRAWING IS A CONTROLLED DOCUMENT.		DWN S. WELDON 05FEB2003
DIMENSIONS: mm		CHK C. RICHARD 05FEB2003
TOLERANCES UNLESS OTHERWISE SPECIFIED:		APVD C. RICHARD 05FEB2003
0 PLC ±-	±3	PRODUCT SPEC
1 PLC ±.3	±.25	APPLICATION SPEC
2 PLC ±-	±-	WEIGHT
3 PLC ±-	±-	CUSTOMER DRAWING
4 PLC ±-	±2	SCALE 1:1
ANGLES	±2	SHEET 1 OF 8
FINISH		REV E12

**STE** TE Connectivity

NAME: TERMINAL BLOCK, VERTICAL PLUG, STACKING, RIGHT HAND, 5.08mm PITCH

SIZE: A2 CAGE CODE: 0779 DRAWING NO: C-284047

THIS DRAWING IS UNPUBLISHED. RELEASED FOR PUBLICATION 20  
 © COPYRIGHT 20 BY - ALL RIGHTS RESERVED.

REVISIONS				
P	LTR	DESCRIPTION	DATE	APVD
-		SEE SHEET 1	-	-

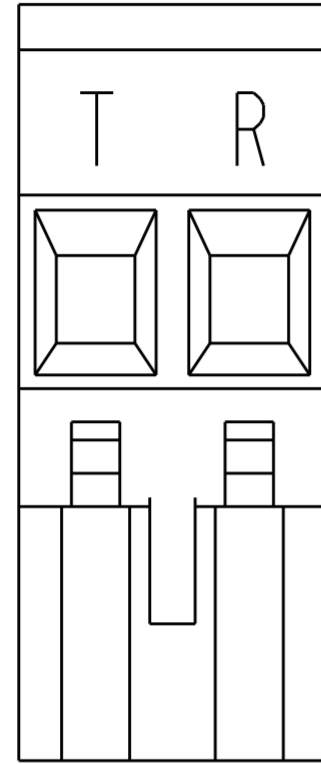

SEE DETAIL L  
 4

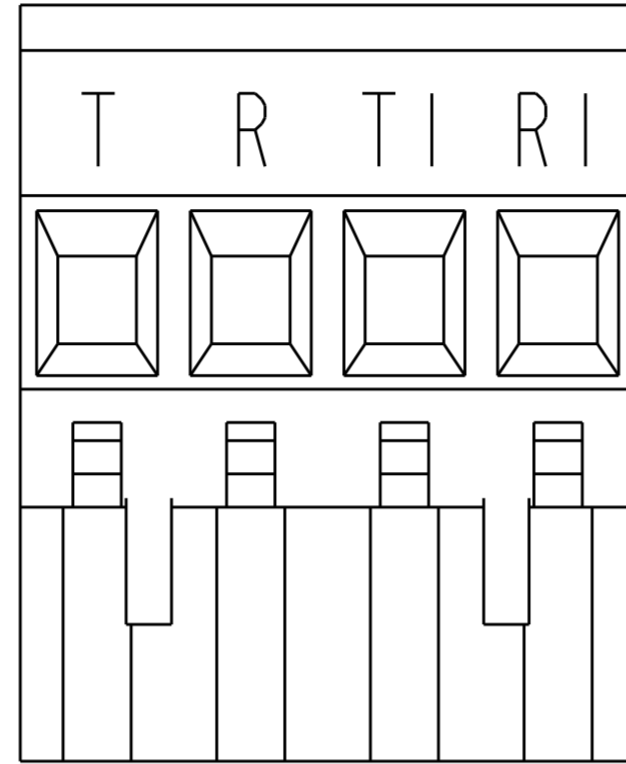

SEE DETAIL M  
 4

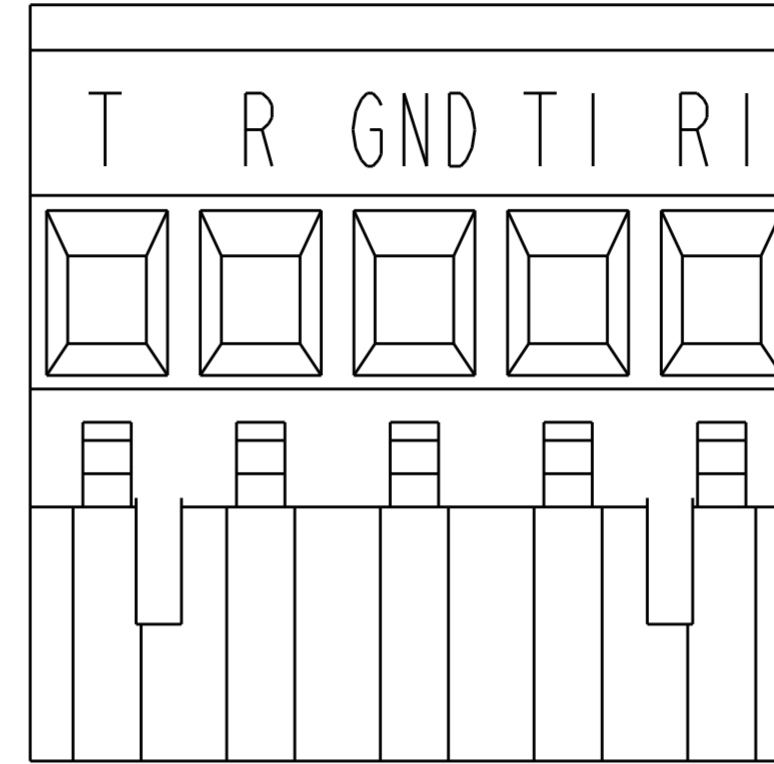

SEE DETAIL N  
 4

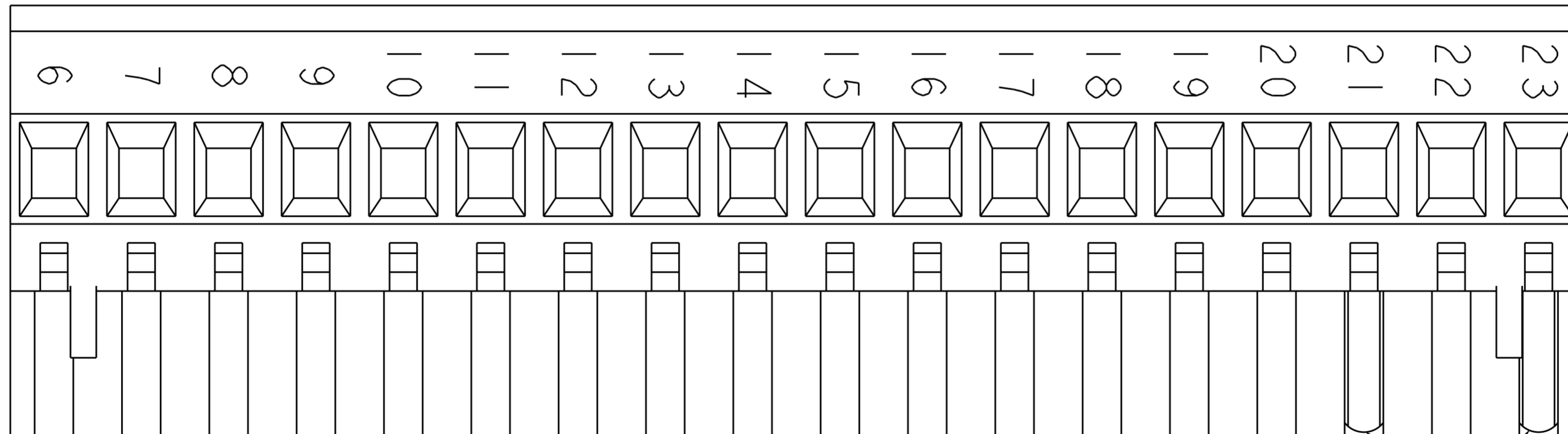

SEE DETAIL P  
 6

CODING KEY

THIS DRAWING IS A CONTROLLED DOCUMENT.		DWN S. WELDON 05FEB2003	TE Connectivity
DIMENSIONS: mm		CHK C. RICHARD 05FEB2003	
TOLERANCES UNLESS OTHERWISE SPECIFIED:		APVD C. RICHARD 05FEB2003	
0 PLC ±- 1 PLC ±.3 2 PLC ±.25 3 PLC ±- 4 PLC ±- ANGLES ±2 FINISH -		PRODUCT SPEC - APPLICATION SPEC - WEIGHT -	
MATERIAL -		NAME TERMINAL BLOCK, VERTICAL PLUG, STACKING, RIGHT HAND, 5.08mm PITCH SIZE A20779 CAGE CODE C-284047 DRAWING NO. RESTRICTED TO - SCALE 1:1 SHEET 2 OF 8 REV E12	
		CUSTOMER DRAWING	

THIS DRAWING IS UNPUBLISHED. RELEASED FOR PUBLICATION 20  
 © COPYRIGHT 20 BY - ALL RIGHTS RESERVED.

REVISIONS				
P	LTR	DESCRIPTION	DATE	APVD
-	-	SEE SHEET 1	-	-

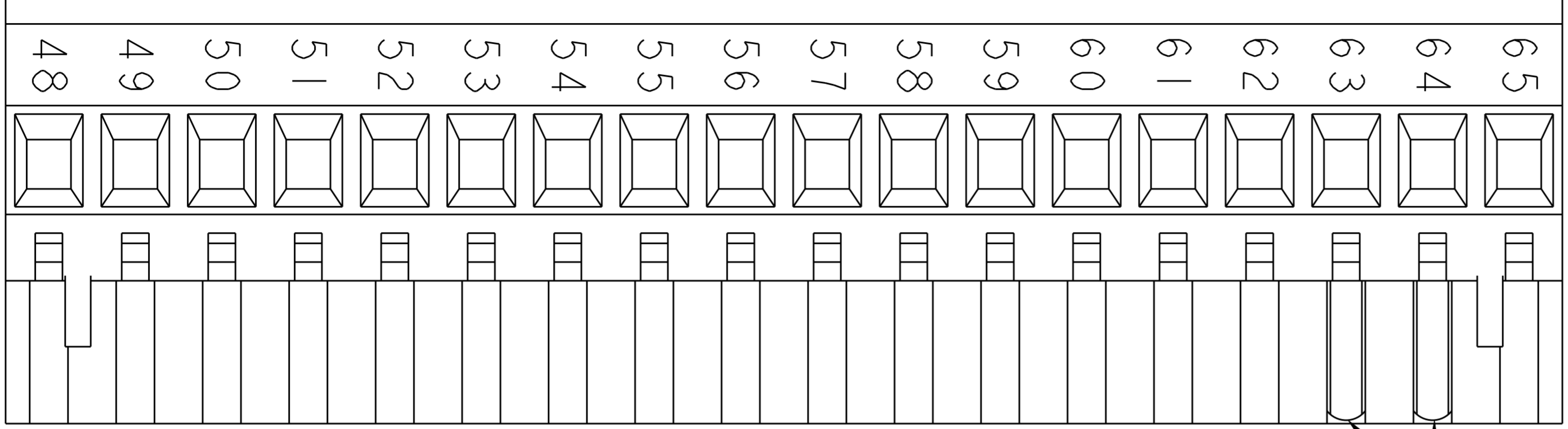

SEE DETAIL R

CODING KEY

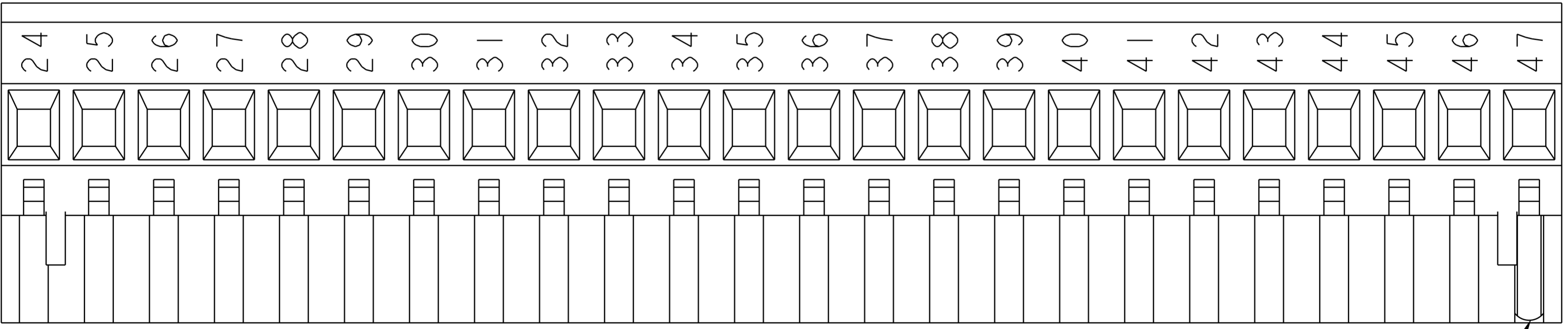

SEE DETAIL S

CODING KEY

THIS DRAWING IS A CONTROLLED DOCUMENT.		DWN S. WELDON 05FEB2003	TE Connectivity	NAME TERMINAL BLOCK, VERTICAL PLUG, STACKING, RIGHT HAND, 5.08mm PITCH
DIMENSIONS:		CHK C. RICHARD 05FEB2003		
mm		APVD C. RICHARD 05FEB2003		
		PRODUCT SPEC		
TOLERANCES UNLESS OTHERWISE SPECIFIED:		APPLICATION SPEC	SIZE	RESTRICTED TO
0 PLC ±-		WEIGHT	A20779	CAGE CODE C-284047
1 PLC ±.3		CUSTOMER DRAWING	SCALE 1:1	
2 PLC ±.25		SCALE 1:1	SHEET 3 OF 8	REV E12
3 PLC ±-				
4 PLC ±-				
ANGLES ±2				
FINISH				

THIS DRAWING IS UNPUBLISHED. RELEASED FOR PUBLICATION 20  
 © COPYRIGHT 20 BY - ALL RIGHTS RESERVED.

REVISIONS				
P	LTR	DESCRIPTION	DATE	APVD
-		SEE SHEET 1	-	-

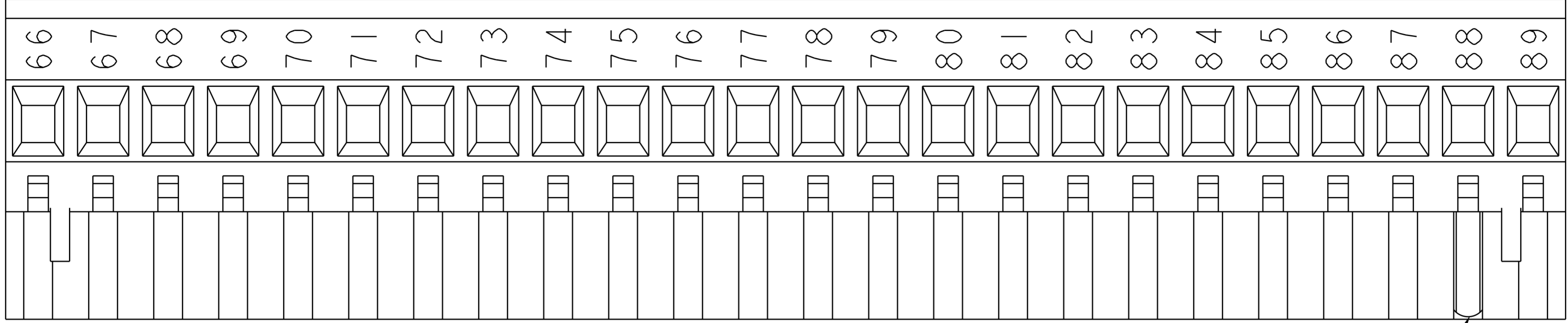

SEE DETAIL T  
 △<sub>6</sub>

CODING KEY

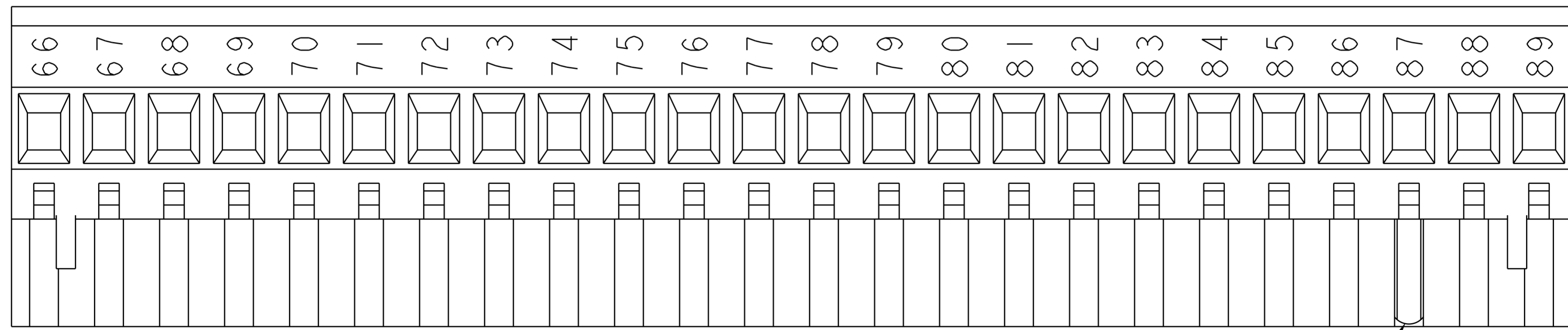

SEE DETAIL Z  
 △<sub>6</sub>

CODING KEY

THIS DRAWING IS A CONTROLLED DOCUMENT.		DWN S. WELDON 05FEB2003	TE Connectivity	
		CHK C. RICHARD 05FEB2003		
		APVD C. RICHARD 05FEB2003	NAME TERMINAL BLOCK, VERTICAL PLUG, STACKING, RIGHT HAND, 5.08mm PITCH	
DIMENSIONS: mm 		PRODUCT SPEC -	SIZE A20779	CAGE CODE C-284047
TOLERANCES UNLESS OTHERWISE SPECIFIED: 0 PLC ±- 1 PLC ±.3 2 PLC ±.25 3 PLC ±- 4 PLC ±- ANGLES ±- FINISH -		APPLICATION SPEC -	DRAWING NO -	RESTRICTED TO -
MATERIAL -		WEIGHT -	SCALE 1:1 SHEET 4 OF 8 REV E12	
CUSTOMER DRAWING				

THIS DRAWING IS UNPUBLISHED. RELEASED FOR PUBLICATION 20  
 © COPYRIGHT 20 BY - ALL RIGHTS RESERVED.

REVISIONS				
P	LTR	DESCRIPTION	DATE	APVD
-		SEE SHEET 1	-	-

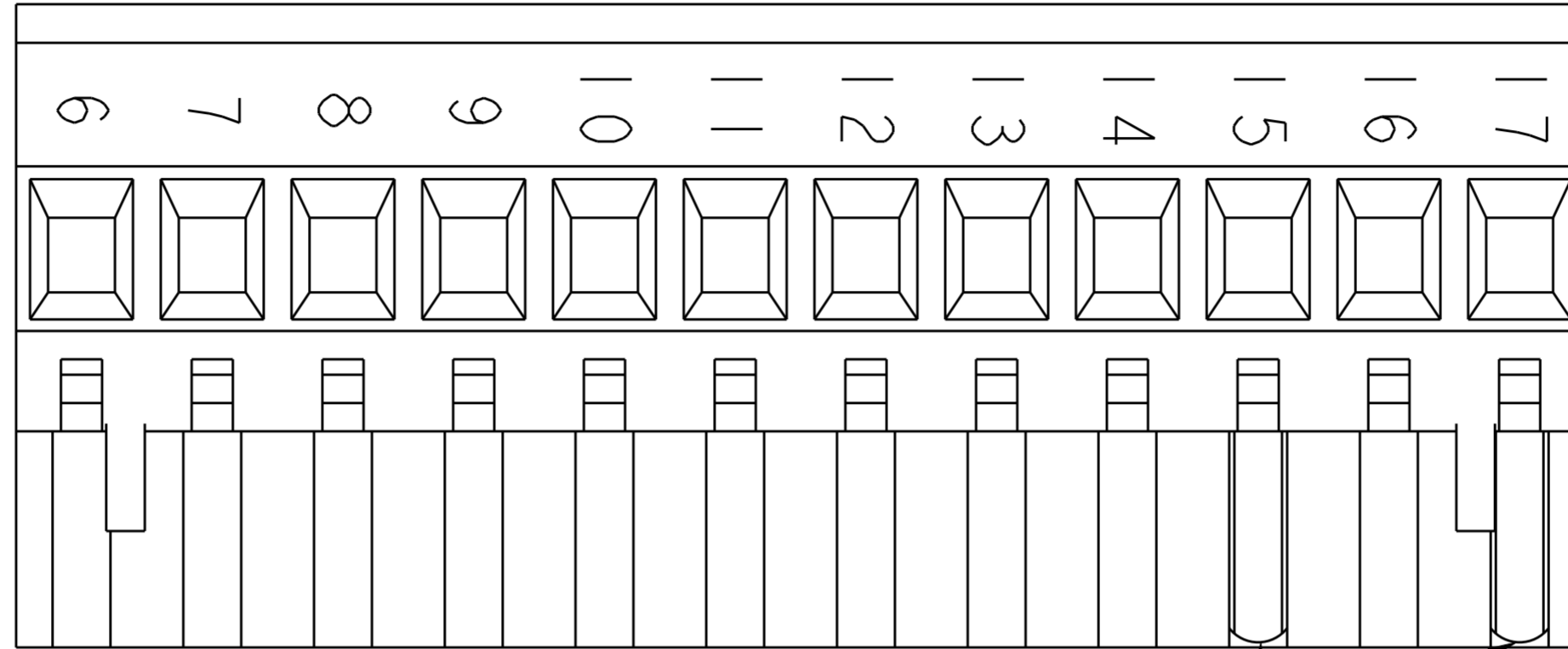

SEE DETAIL U



CODING KEY

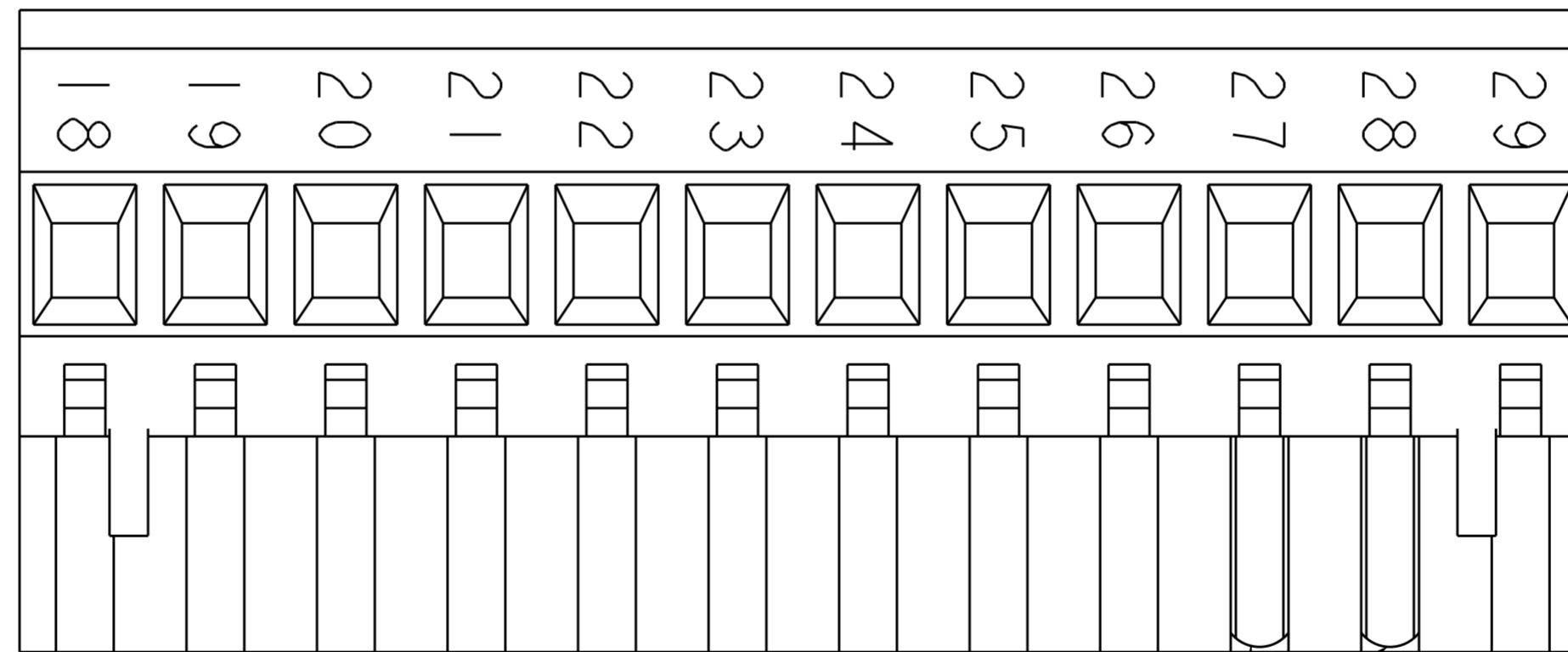

SEE DETAIL V



CODING KEY

THIS DRAWING IS A CONTROLLED DOCUMENT.		DWN S. WELDON 05FEB2003	TE Connectivity
		CHK C. RICHARD 05FEB2003	
		APVD C. RICHARD 05FEB2003	
		PRODUCT SPEC	
DIMENSIONS:		NAME	
mm	TOLERANCES UNLESS OTHERWISE SPECIFIED:	TERMINAL BLOCK, VERTICAL PLUG, STACKING, RIGHT HAND, 5.08mm PITCH	
	0 PLC ±-	SIZE	RESTRICTED TO
	1 PLC ±.3	A20779	-
	2 PLC ±.25	CAGE CODE	DRAWING NO
	3 PLC ±-	C-284047	SCALE
	4 PLC ±-	WEIGHT	1:1
	ANGLES ±2	CUSTOMER DRAWING	SHEET
	FINISH		5 OF 8
MATERIAL			REV
			E12

THIS DRAWING IS UNPUBLISHED. RELEASED FOR PUBLICATION 20  
 © COPYRIGHT 20 BY - ALL RIGHTS RESERVED.

REVISIONS				
P	LTR	DESCRIPTION	DATE	APVD
-	-	SEE SHEET 1	-	-

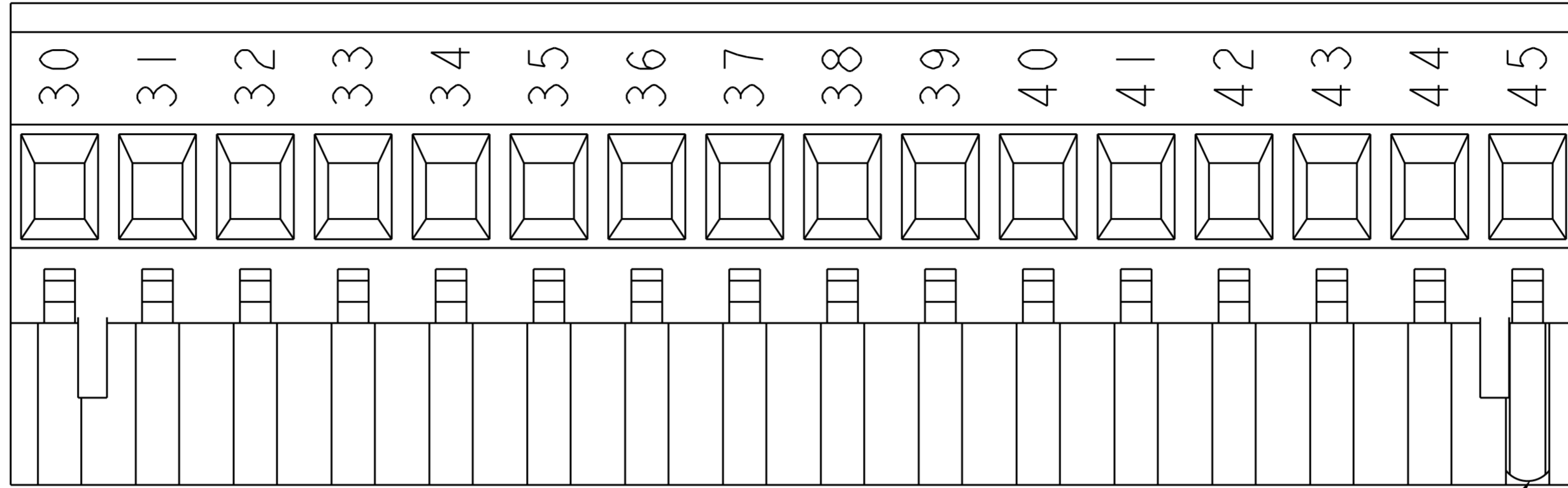

SEE DETAIL W



CODING KEY

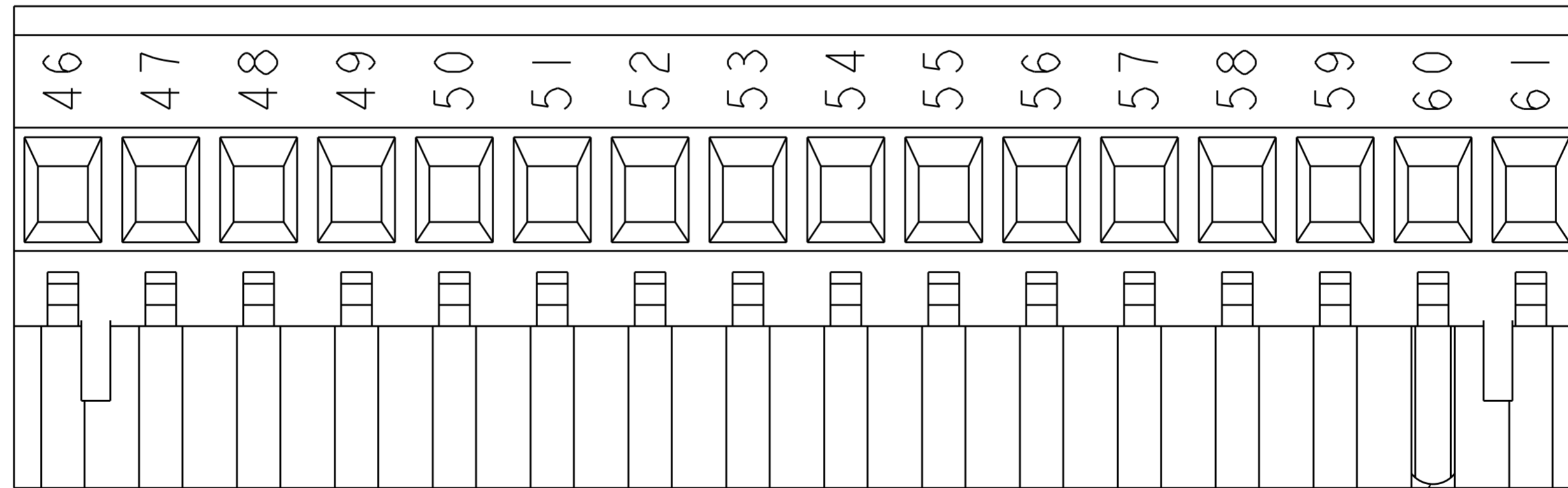

SEE DETAIL X

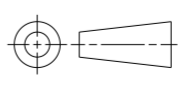

CODING KEY

THIS DRAWING IS A CONTROLLED DOCUMENT.		DWN S. WELDON 05FEB2003	 TE Connectivity
DIMENSIONS:		CHK C. RICHARD 05FEB2003	
TOLERANCES UNLESS OTHERWISE SPECIFIED:		APVD C. RICHARD 05FEB2003	
mm		PRODUCT SPEC	
		APPLICATION SPEC	NAME TERMINAL BLOCK, VERTICAL PLUG, STACKING, RIGHT HAND, 5.08mm PITCH
MATERIAL	0 PLC ±- 1 PLC ±.3 2 PLC ±.25 3 PLC ±- 4 PLC ±- ANGLES ±2 FINISH	WEIGHT	SIZE CAGE CODE DRAWING NO RESTRICTED TO A20779 C-284047 -
-	-	CUSTOMER DRAWING	SCALE 1:1 SHEET 6 OF 8 REV E12

THIS DRAWING IS UNPUBLISHED. RELEASED FOR PUBLICATION 20  
 © COPYRIGHT 20 BY - ALL RIGHTS RESERVED.

REVISIONS				
P	LTR	DESCRIPTION	DATE	APVD
-		SEE SHEET 1	-	-

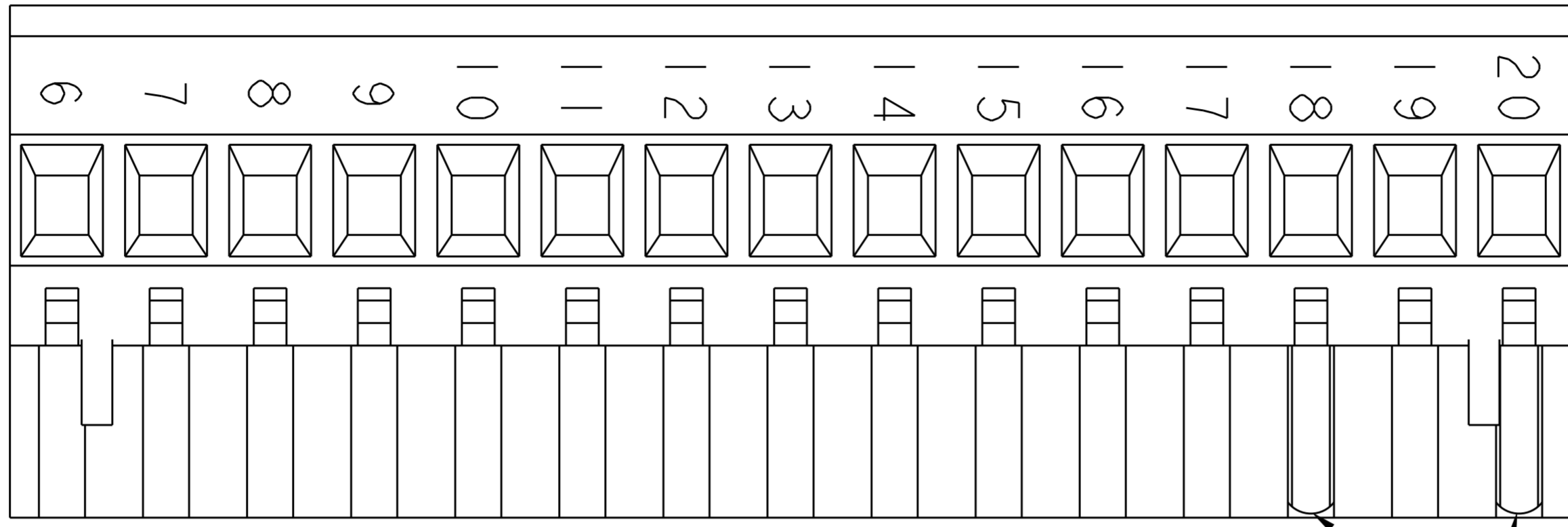

SEE DETAIL A-A



CODING KEY

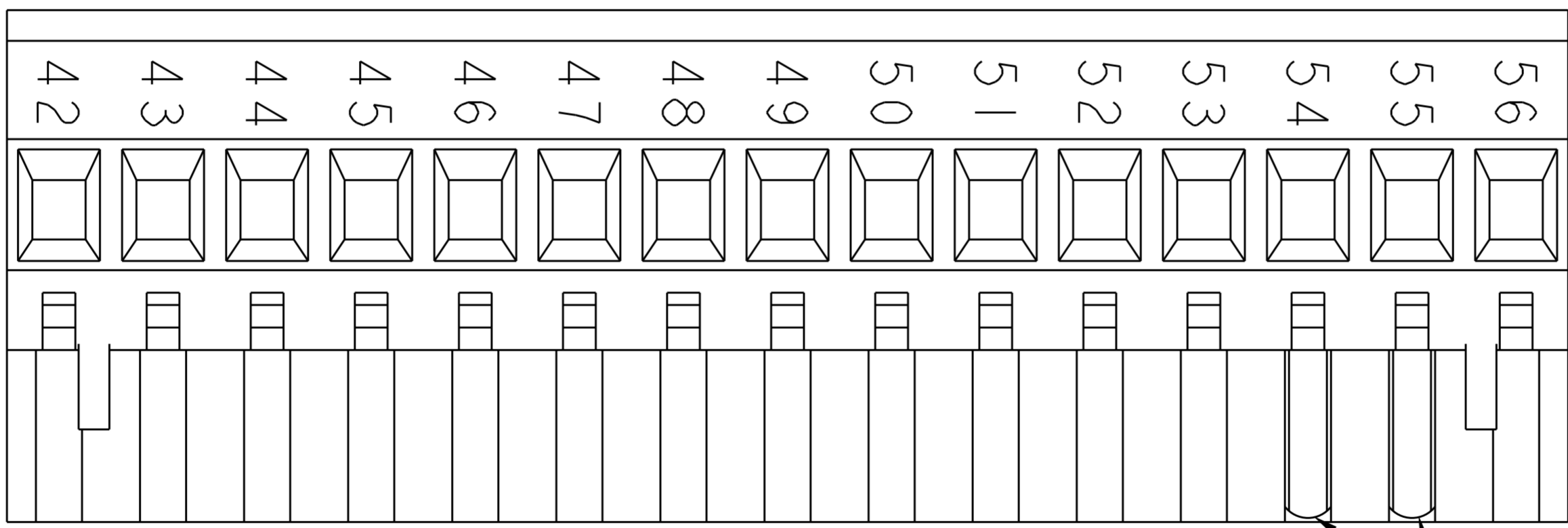

SEE DETAIL A-B



CODING KEY

THIS DRAWING IS A CONTROLLED DOCUMENT.		DWN S. WELDON 05FEB2003	TE Connectivity	
DIMENSIONS: mm		CHK C. RICHARD 05FEB2003		
TOLERANCES UNLESS OTHERWISE SPECIFIED:		APVD C. RICHARD 05FEB2003	NAME TERMINAL BLOCK, VERTICAL PLUG, STACKING, RIGHT HAND, 5.08mm PITCH	
0 PLC ±- 1 PLC ±.3 2 PLC ±.25 3 PLC ±- 4 PLC ±- ANGLES ±2 FINISH -		PRODUCT SPEC -	SIZE A20779	DRAWING NO C-284047
MATERIAL -		APPLICATION SPEC -	RESTRICTED TO -	SCALE 1:1
		WEIGHT -	SHEET 7 OF 8	
		CUSTOMER DRAWING	REV E12	

THIS DRAWING IS UNPUBLISHED. RELEASED FOR PUBLICATION 20  
 © COPYRIGHT 20 BY - ALL RIGHTS RESERVED.

REVISIONS				
P	LTR	DESCRIPTION	DATE	APVD
-		SEE SHEET 1	-	-

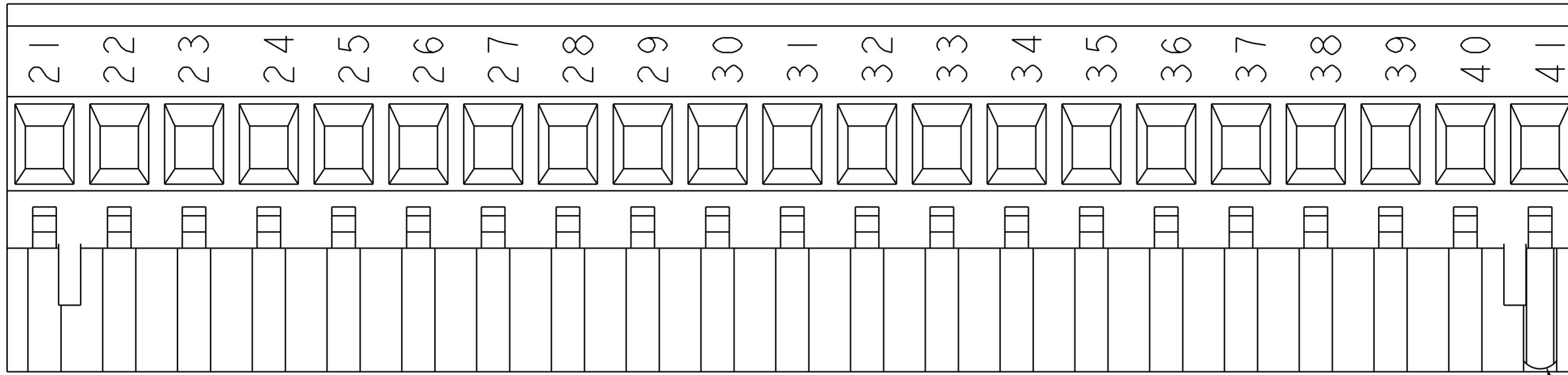

SEE DETAIL A-C



CODING KEY

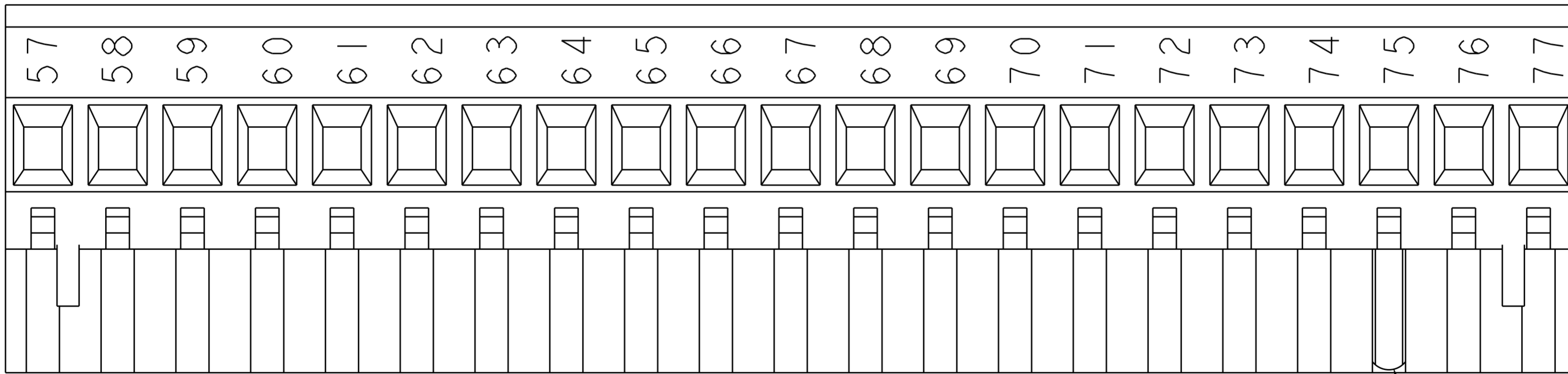

SEE DETAIL A-D



CODING KEY

THIS DRAWING IS A CONTROLLED DOCUMENT.		DWN S. WELDON 05FEB2003	 TE Connectivity	NAME		
DIMENSIONS:		CHK C. RICHARD 05FEB2003		TERMINAL BLOCK, VERTICAL PLUG,		
mm		APVD C. RICHARD 05FEB2003		STACKING, RIGHT HAND,		
		PRODUCT SPEC		5.08mm PITCH		
TOLERANCES UNLESS OTHERWISE SPECIFIED:		APPLICATION SPEC	SIZE	CAGE CODE	DRAWING NO	RESTRICTED TO
0 PLC ±-		WEIGHT	A2	0779	C-284047	-
1 PLC ±.3		CUSTOMER DRAWING	SCALE	1:1	SHEET	8 OF 8
2 PLC ±.25					REV	E12
3 PLC ±-						
4 PLC ±-						
ANGLES ±2						
FINISH						