

75 Watts

- Ultra Slim Design - 32 mm
- 150% Peak Load for 3 seconds
- Ambient Operation from -25 °C to +70 °C
- Full Load at 60 °C
- High Efficiency - Up to 91%
- Volt-Free Contact for DC OK
- Selectable Parallel Operation
- 85 to 264 VAC Operation
- 3 Year Warranty



Dimensions:

DSR75:

1.26 x 4.88 x 4.69" (32.0 x 124.0 x 119.0 mm)

Models & Ratings

Output Voltage	Output Power	Output Voltage Trim ⁽³⁾	Output Current	Peak Current ⁽²⁾	Typical Efficiency ⁽¹⁾	Model Number
12 V	75 W	12.0-14.0 V	6.3 A	9.45 A	88%	DSR75PS12
24 V	75 W	24.0-28.0 V	3.2 A	4.80 A	91%	DSR75PS24
48 V	75 W	48.0-56.0 V	1.6 A	2.40 A	91%	DSR75PS48

Notes

1. Typical efficiency at 230 VAC and full load.
2. Peak current is for a maximum of 3 s, see Application Notes. Average power is not to exceed nominal output power.
3. Output current should be limited so that nominal output power is not exceeded.

Mechanical Details

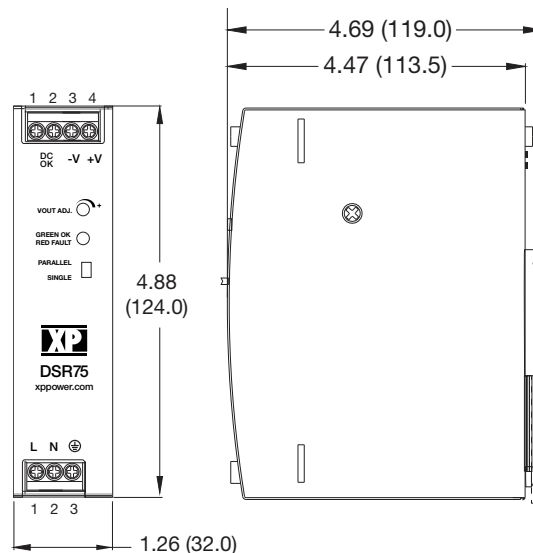

Pin Connector		
Conn	Pin	Designation
AC I/P	1	L
	2	N
	3	Ground
DC O/P	1	DC OK
	2	DC OK
	3	-Vout
	4	+Vout

Notes

1. All dimensions in inches (mm)
2. Weight: 1.06 lbs (480g)
3. Tolerance: ±0.02 in (±0.5 mm)

Input

Characteristic	Minimum	Typical	Maximum	Units	Notes & Conditions
Input Voltage - Operating	85		264	VAC	
Input Frequency	47	50/60	63	Hz	
Power Factor		0.95			At 230 VAC. Conforms to EN61000-3-2 Class A
Input Current - Full Load		0.8/0.4		A	115/230 VAC
Inrush Current			30/60	A	At 115/230 VAC. Cold start, 25 °C
Earth Leakage Current			1.0	mA	At 264 VAC, 60 Hz
Input Protection	T5.0 A / 250 V internal in-line fuse				

Output

Characteristic	Minimum	Typical	Maximum	Units	Notes & Conditions
Output Voltage - V1	12		48	VDC	See Models and Ratings table
Initial Set Accuracy			±1	%	At 100% load
Output Voltage Adjustment				%	See Models and Ratings table
Minimum Load	0			A	No minimum load required
Start Up Delay			500	ms	At 100 VAC
Hold Up Time	20			ms	At full load
Line Regulation			±0.5	%	
Load Regulation			±1	%	
Transient Response - V1			5	%	Recovery within 1% in less than 200 µs for a 50% step load change at 0.2 A/µs
Ripple & Noise			100/120/240	mV pk-pk	12 V/24 V/48 V models. Measured at 20 MHz bandwidth 0-70°C
			200/240/240		12 V/24 V/48 V models. Measured at 20 MHz bandwidth -25-0°C
Overvoltage Protection	15		20	V	12 V model, at 115/230 VAC input
	29		40	V	24 V model, at 115/230 VAC input
	58		65	V	48 V model
Overload Protection	110		150	%	Trip & restart. See application note.
Short Circuit Protection					Trip & restart (hiccup mode), auto recovery
Thermal Protection		110 ±10		°C	Measured internally, recycle AC to reset
Temperature Coefficient			0.03	%/°C	
Parallel Operation	See application notes				

General

Characteristic	Minimum	Typical	Maximum	Units	Notes & Conditions
Efficiency		91		%	See Models & Ratings table
Isolation: Input to Output Input to Ground Output to Ground	3000			VAC	
	2500			VAC	
	500			VAC	
Switching Frequency		65		kHz	PFC, fixed
	60		400	kHz	Main converter, variable, at 115/230 VAC input
DC OK Signal	Volt free contacts rated at 60 VDC/0.3 A, 30 VDC/1.0 A or 30 VAC/0.3 A (resistive load)				
Output LED	Green LED to indicate output on.				
Mean Time Between Failure	300			kHrs	MIL-HDBK-217F, +25 °C GB
Weight		1.06 (480)		lb (g)	

Environmental

Characteristic	Minimum	Typical	Maximum	Units	Notes & Conditions
Operating Temperature	-25		+70	°C	See derating curve in Application Notes
Storage Temperature	-40		+85	°C	
Cooling					Natural convection
Operating Humidity	20		95	%RH	Non-condensing
Operating Altitude			5000	m	
Shock		4		g	IEC68-2-27, 22 ms half sine, 3 times in each of 6 axes
Vibration		2		g	IEC68-2-6, 10-500 Hz, 10 mins/sweep. 60 mins for each of 3 axes

EMC: Emissions

Phenomenon	Standard	Test Level	Criteria	Notes & Conditions
Conducted	EN55032	Class B		
Radiated	EN55032	Class B		
Harmonic Current	EN61000-3-2	Class A		
Voltage Fluctuations	EN61000-3-3			

EMC: Immunity

Phenomenon	Standard	Test Level	Criteria	Notes & Conditions
ESD Immunity	EN61000-4-2	6 kV	A	Contact
		8 kV		Air Discharge
Radiated Immunity	EN61000-4-3	10 V/m	A	
EFT/Burst	EN61000-4-4	3	A	
Surges	EN61000-4-5	Installation class 3	A	
Conducted	EN61000-4-6	10 V	A	
Magnetic Fields	EN61000-4-8	4	A	
Dips and Interruptions	EN55035	Dip: 30%, 10 ms	A	
		Dip: 60%, 100 ms	A/B	High Line/Low Line
		Dip: 100%, 5000 ms	B	

Safety Approvals

Safety Agency	Safety Standard	Notes & Conditions
UL	UL508/UL60950	Industrial Control Equipment/Information Technology
TUV	EN62368-1	Information Technology
CE	Meets all applicable directives	
UKCA	Meets all applicable legislation	

Mechanical Details

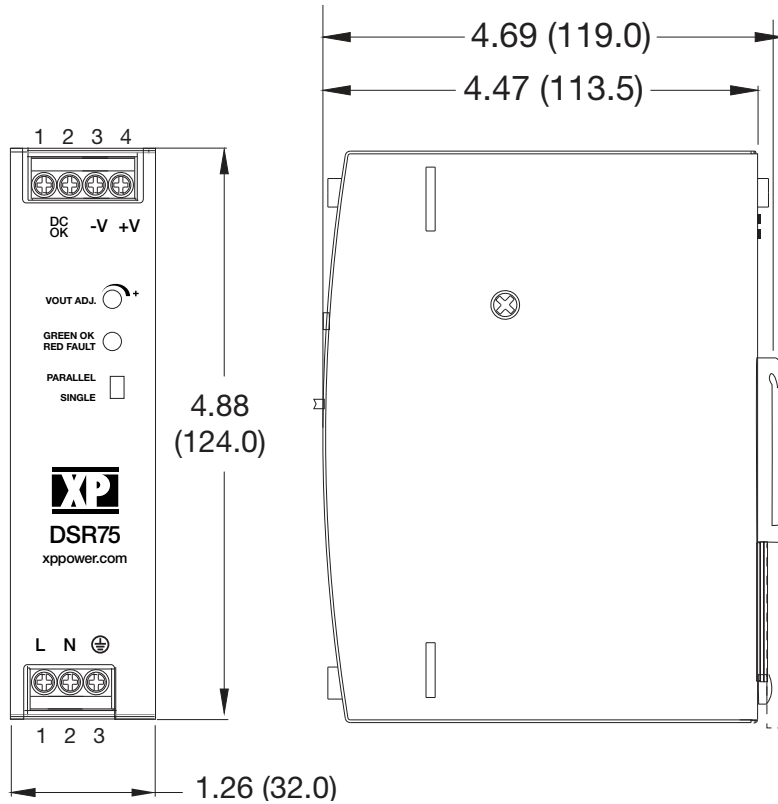

Pin Connector		
Conn	Pin	Designation
AC I/P	1	L
	2	N
	3	Ground
DC O/P	1	DC OK
	2	DC OK
	3	-Vout
	4	+Vout

Notes

- All dimensions in inches (mm)
- Weight: 1.06 lbs (480 g)
- Tolerance: ± 0.02 in (± 0.5 mm)

Application Notes

Derating Curves

DSR75PS12

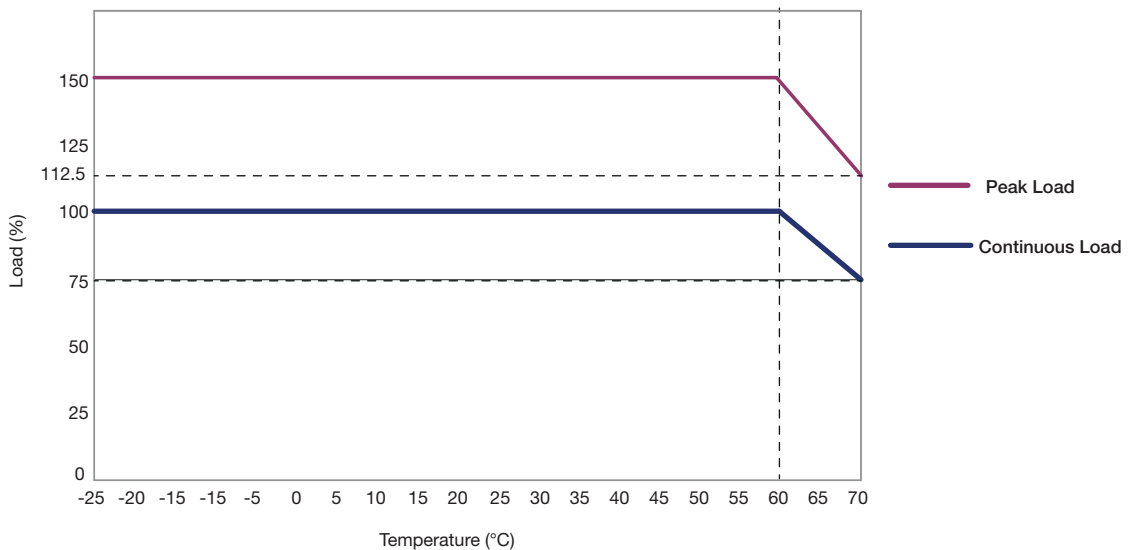

Application Notes

Derating Curves

DSR75PS24

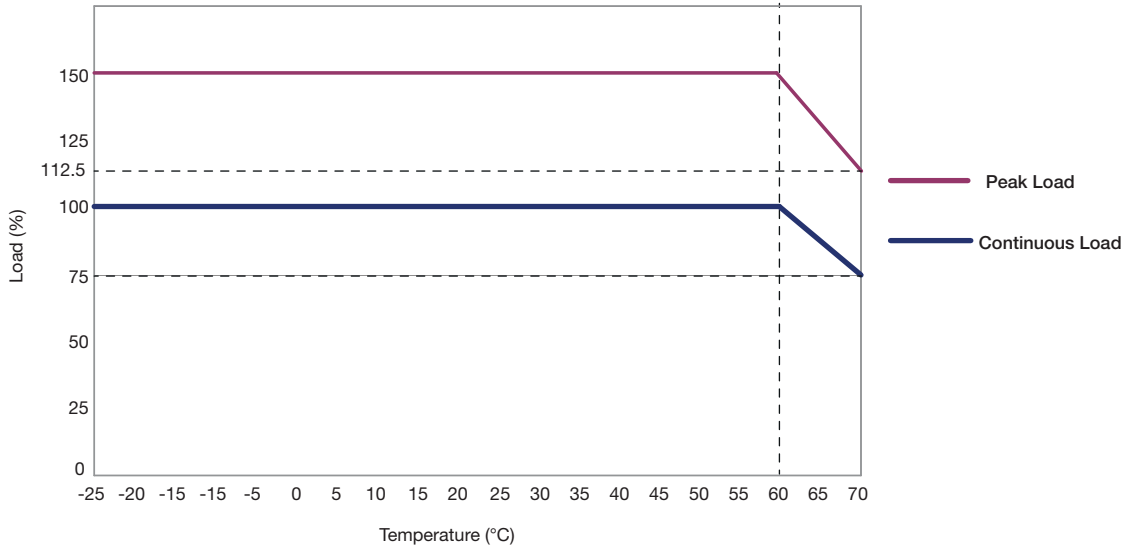

DSR75PS48

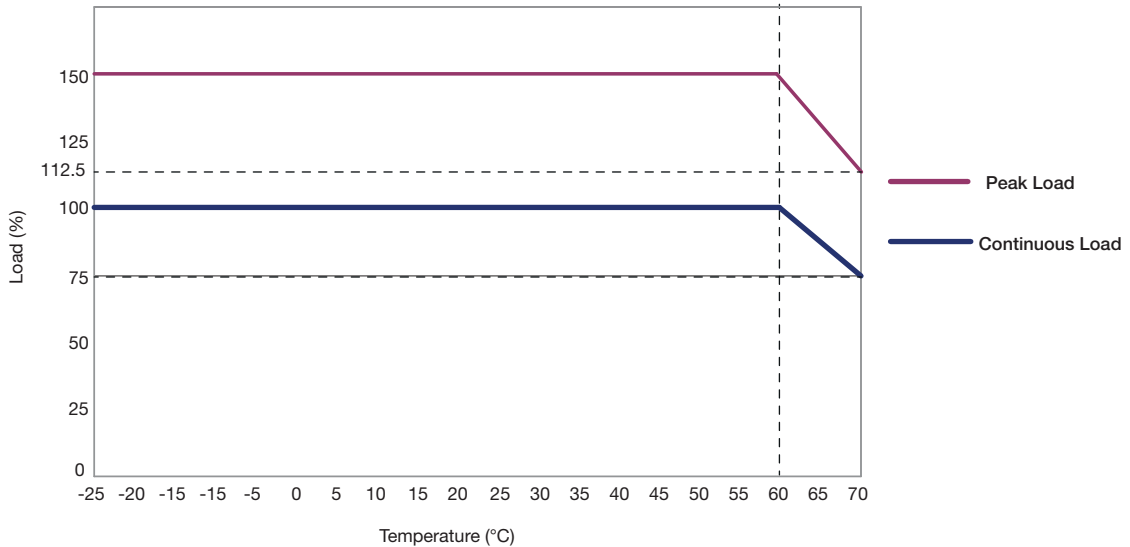

DC OK

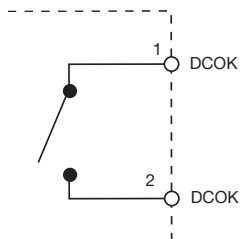

Open = Output fail, if voltage drops below 80% of nominal
 Closed = Output good

Contact Rating: 0.3 A at 60 VDC, 1.0 A at 30 VDC, 0.5 A at 30 VAC.
 500 VDC isolation to output.

Application Notes

Parallel and Redundant Operation

To increase the available power the DSR75 can be used in parallel configuration with other matching DSR75 power supplies.

Up to five DSR75 power supplies can be connected in parallel without the need of a redundancy module or isolating diode.

- 1) Each power supply should be separately fused on the AC input.
- 2) Set output voltages to the same level within $\pm 100\text{mV}$ based on same loading.
- 3) Enable switch from "Single" to "Parallel" on the front panel of each power supply.
- 4) Check individual DSR75 status via green "OK" LED
- 5) Enable and disable all power supplies simultaneously.

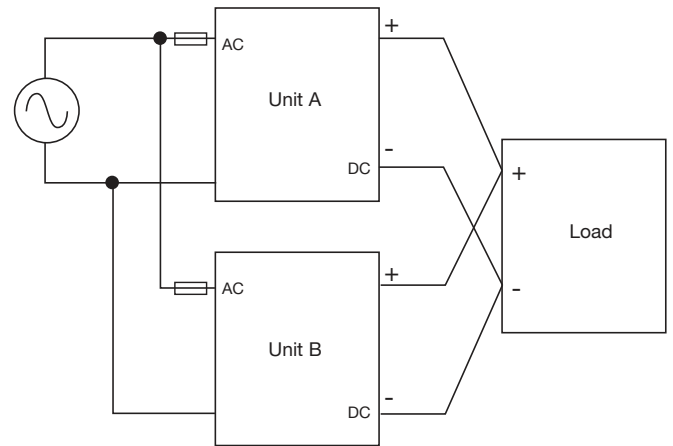

Notes:

- a. Simple parallel configuration will potentially overload individual units in the event of unit disconnect or failure.
- b. For higher system integrity DSR75 outputs should each be protected by an isolating diode or circuit breaker.
- c. Redundant configuration can be used for higher system reliability. In this configuration of 1+1 to share loading the outputs must be protected from each other.

Peak Load and Overload

A peak load can be used for a certain period after which the output goes into overload mode. Overload operation is trip and restart. The peak load duration depends on the value of the load, e.g. a peak load of 150% can be taken for approximately 3s. After this time the output will turn off for approximately 7s before turning back on.

If the load has reduced to 100% or less than normal operation is resumed. If the load remains at 150% then the output is maintained for a further 3s before turning off for 7s. See example plot below.

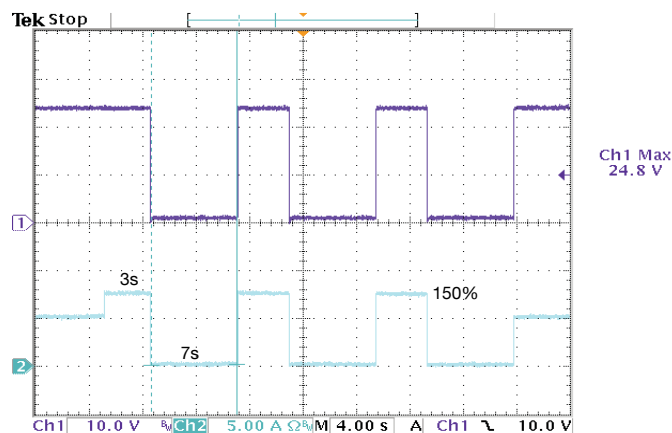

If the peak load is less than 150%, the duration of the peak can be longer than 3s before the output turns off, for example, a peak load of 130% could typically be taken for up to 13s and a peak load of 140% could typically be taken for up to 5s. The off duration is always approximately 7s.

Average power is not to exceed nominal output power.