

Electro-pneumatic control valves



Visit our website for further information www.crouzet.com



Miniature solenoid valves

- Terminals
- Wires
- Connector

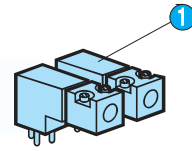

LED indicators

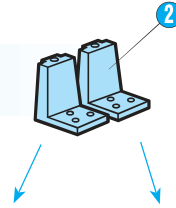

Valve modules

- **Poppet valve**
 - 3/2 monostable (17.5 mm)
 - 4/2 monostable (17.5 mm)
- **With slide valve**
 - 4/2 bistable (35 mm)
 - 4/2 spring monostable (35 mm)

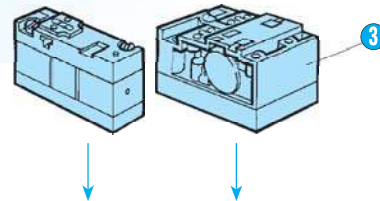

Modular sub-bases

- Single
- Double
- End bases
- Intermediate supply module

For valve modules

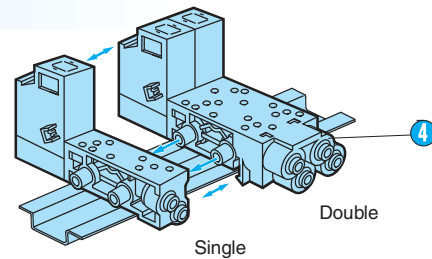

Complete product

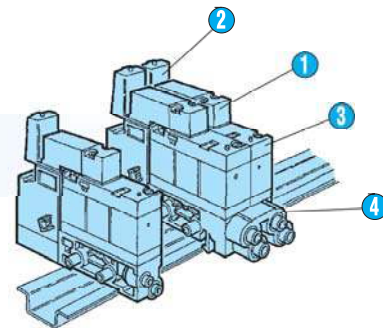

Our assemblies are certified category 2



Miniature solenoid valves

LCIE notification
no. LCIE 03 ATEX Q8002

EC Type Examination Certificate LCIE 02 ATEX 6122X
Conforming to the Low Voltage Directive 73/23/EEC
modified by Directive 93/68/EEC

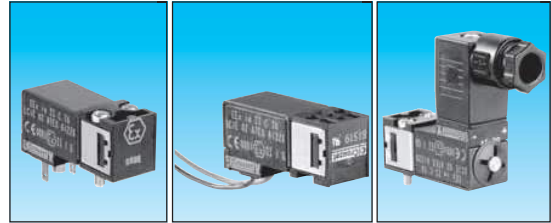

Type	Terminal	Wire	Connector
Degree of protection (CEI 529)	IP 20		IP 65
Classification	CE Ex II 1 G Ex ia II CT6		CE Ex II 1 GD Ex ia II CT6 Ex ia D20T80°C
Manual override	Without		
U nominale	12 Vdc		
Power source (barrier or interface output) between 5 and 18 Vdc	Max. power consumption	0.70 W	
U nominale	24 Vdc		
Power source (barrier or interface output) between 12 and 28 Vdc	Max. power consumption	0.70 W	
Function	3/2 NC		

Symbols



Characteristics

Permitted fluids	Wiretered 50 µ, lubricated (ASTM2) or no	air or inert gases		
Working pressure	bars	1 → 7		
Orifice diameter	mm	0.5		
Flow at 6 bars	NL/mn	12		
Flow rate	KV	0.12		
Operating temperature	°C	- 10 at + 50		
Switching time	ms	8 at 15		
Mechanical life (at 4 bars and 20°C)	operations	≤ 1.5 · 10 ⁷		
Construction	st. steel, NBR brass, PA 66			
Duty factor		100% ED		
Insulation class	CEI 85	F		
Weight	g	35	38	45

Pneumatic connections

On Valve modules	types 81 513 196 /234 /612
	types 81 516 107 /208

Electrical connections

	2 Terminals	2 Wires	Connector
With 4 possible positions	●	●	●
Via modular sub-bases	81 513 075 /076	—	—
Via wires - 300 mm long - cross-section 0.22 mm ²	81 517 106 /206	—	—

Dimensions

Terminals
81 519 034
81 519 334
81 519 634

81 519 035
81 519 335
81 519 635

Wires
81 519 037

Connectors
81 519 047
81 519 347
81 519 647

81 519 048
81 519 348
81 519 648

15 x 15 mm footprint

According to CNOMO E 06-36-120V

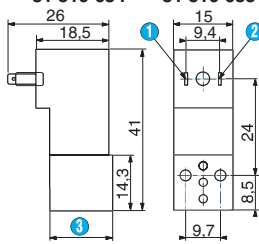

- ① 2.8 x 0.5 terminal ⊕
- ② 2.8 x 0.5 terminal ⊖
- ③ 16 mm or 21 mm with manual override

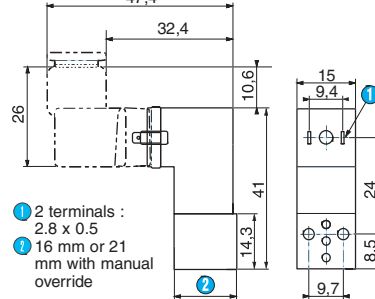
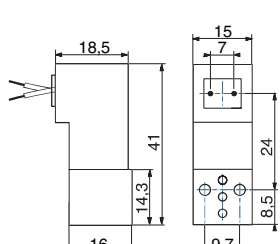

- ① 2 terminals : 2.8 x 0.5
- ② 16 mm or 21 mm with manual override

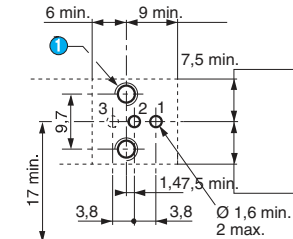

- ① 2 x M3 - depth 6
- 1 - Supply
- 2 - Output
- 3 - Exhaust

Other information

Note:
Our IP20 miniature solenoid valves (except for those using wire connections) have a location-coding pin, which prevents them from being mounted on our standard sub-bases. They must only be used with the sub-bases mentioned on page 8 of this catalogue.
If they are being installed with a separate electrical connector, only our 81 516 082 connector should be used in order to comply with safety level EEx ia II CT6.

To order an product, you must complete the form on page 53.

Important

These ATEX miniature solenoid valves must be connected individually to an approved safety barrier. Placed in a safe zone, these safety barriers can be used to supply power to ATEX miniature solenoid valves installed in a hazardous zone.

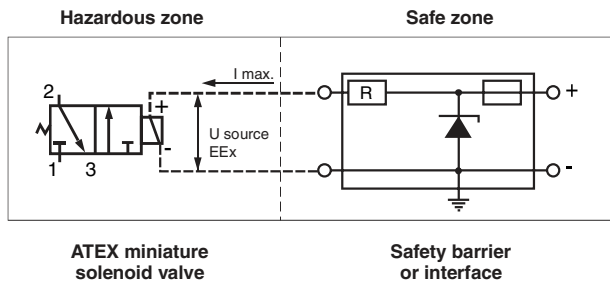

Specifications for loop calculation

	12 Vdc	24 Vdc
	81519034 81519047	81519035 81519037 81519048
	81519334 81519347	81519335 81519348
	81519634 81519647	81519635 81519648
U source EEx	< 18 V	< 28 V
I _{max} / coil	< 74 mA	< 37 mA
C _{int}	0	0
R at + 20° C	147 Ohm +/- 7 %	580 Ohm +/- 7 %
R at - 10° C	> 119 Ohm	> 476 Ohm
R at + 50° C	< 174 Ohm	< 690 Ohm

U source EEx = intrinsically safe power source at the terminals of the miniature solenoid valve
 I_{max}/coil = maximum current through the coil
 C_{int} = internal capacity of the solenoid valve
 R = internal resistance of the solenoid valve

The electrical connection between the safety barrier (or interface) and the miniature solenoid valve can be made using ordinary wires or cables. The inductance of the connecting line between the safety barrier and the miniature solenoid valve must be less than 0.5 mH.

Recommended barriers and interfaces

These safety barriers and interfaces, recommended by CROUZET, should be obtained from one of the manufacturers indicated below, specifying that they are to be used to supply power to miniature solenoid valves Type 81 519, CE 0081 Ⓔ II 1 G, approval no. LCIE 02 ATEX 6122 X OR type 81 519, CE 0081 Ⓔ II 1 GD, approval no. LCIE 02 ATEX 6122 X.

Crouzet product	Barriers / Interface	Group of Gas	Part number	Manufacturer	Certificate	Um (V)	I _{cc} (mA)	C (nC)	L (mH)	Loop calculation	Barrier supply voltage
12 Vdc	Barriers	IIC	BZC13/100/1/179	Georgin	O1ATEX 6070X	17.6	124	300	2.2	conforms	12 Vdc +/-10%
	Barriers	IIC	MTL 7715+	MTL	BASO1ATEX 7217	15	150	580	1.45	conforms	12 Vdc+10% : -15%
24 Vdc	Barriers	IIC	24/50/1/A1	Georgin	O1ATEX 6070X	28	93	83	4.4	conforms	24 Vdc +/-10%
	Barriers	IIC	MTL 7728+	MTL	BASO1ATEX 7217	28	93	83	1.82	conforms	20 to 26,6 Vdc
	Interface	IIC	BXNE 09	Georgin	O2ATEX 6104X	23.5	64	13200	9	conforms	24 dc +/-10%

CAUTION: When being used in zone 0 a system certificate supplied by an approved body must be obtained. In zones 1 and 2, the system integrity should be checked with a loop calculation; given that our product C = 0, cable C must be less than barrier C.



Valve modules in potentially explosive atmospheres ATEX Directive 94/9/EC

FILE No. C.PN.HOM.00004.FR
 INERIS No. 17564/04
 for 81 516 107 and 81 516 208

FILE No. C.PN.HOM.00005.FR
 INERIS No. 17567/04
 for 81 513 196, 81 513 612 and 81 513 234

Equipment intended for use in potentially explosive atmospheres conforming to Directive 94/9/EC



Type	3/2 NC monostable	3/2 NO monostable	4/2 monostable	4/2 bistable	4/2 monostable
Classification	81 513 196	81 513 612	81 513 234	81 516 208	81 516 107
	CE II 2 GD c II B 55°C T6X				CE II 2 G c II B 55 °CT6X

Symbol

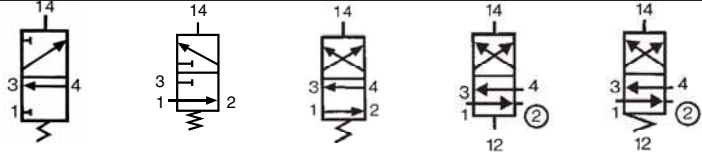

Characteristics

Width	mm	17.5	17.5	17.5	35	35
Working pressure	bars	3-8	3-8	3-8	2-8	3.5-8
Orifice diameter	mm	3	3	3	4	4
Flow at 6 bars	with Ø 4 mm sub-base (page 44)	200	200	200	300	300
	with Ø 6 mm sub-base (page 44)	300	300	300	400	400
Flow Rate	with Ø 4 mm sub-base (page 44)	2.2	2.2	2.2	4	4
	with Ø 6 mm sub-base (page 44)	2.5	2.5	4	5	5
Operating temperature	° C	-10 at +50	-10 at +50	-10 at +50	-10 at +50	-10 at +50
Switching time for the valve only	ms	15	15	15	50	50
Mechanical life	operations	1.5 x 10 ⁷	1.5 x 10 ⁷	1.5 x 10 ⁷	10 ⁷	10 ⁷
Weight	g	38	38	38	106	106

Valve module footprint (pitch 17.5 mm)

81 513 196 - 81 513 234 - 81 513 612

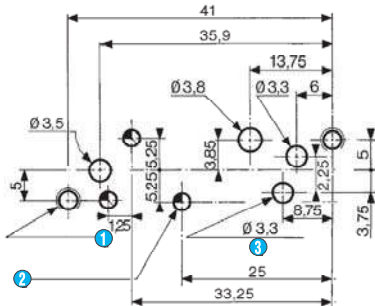

- 1 2 M4 holes – depth of thread: 10 mm min.
- 2 3 Ø 2.8 holes - depth: 3
- 3 4/2 only

Valve module footprint (pitch 35 mm)

81 516 107 - 81 516 208

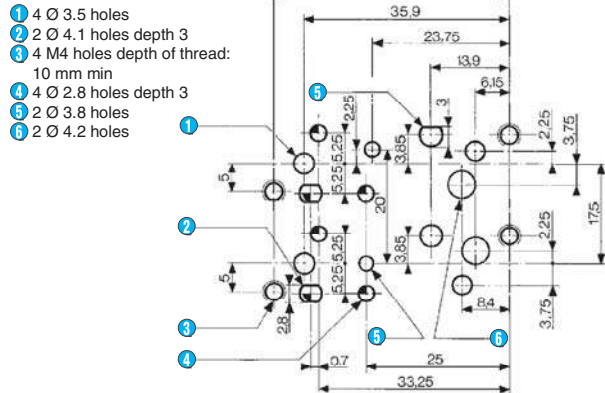

- 1 4 Ø 3.5 holes
- 2 2 Ø 4.1 holes depth 3
- 3 4 M4 holes depth of thread: 10 mm min
- 4 4 Ø 2.8 holes depth 3
- 5 2 Ø 3.8 holes
- 6 2 Ø 4.2 holes

Dimensions

81 513

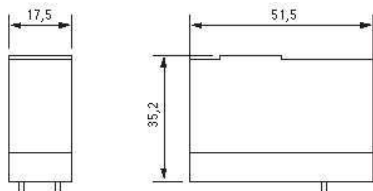

81 516

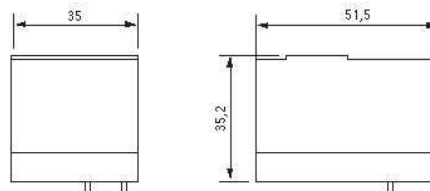

Other information

If mounted in a bank, this should consist of no more than four 81 516 107/208 products or no more than eight 81 513 196/234/612 products

To order an product, you must complete the form on page 53.



Sub and end bases for miniature solenoid valves and valve modules

LCIE notification

no. LCIE 03 ATEX Q8002

Sub-base for use with miniature solenoid valves conforming to CE type examination certificate LCIE 02 ATEX 6122X

FILE No. C.PN.HOM.00004.FR

INERIS No. 17564/04

for 81 513 040 and 81 513 039

Equipment intended for use in potentially explosive atmospheres conforming to Directive 94/9/EC

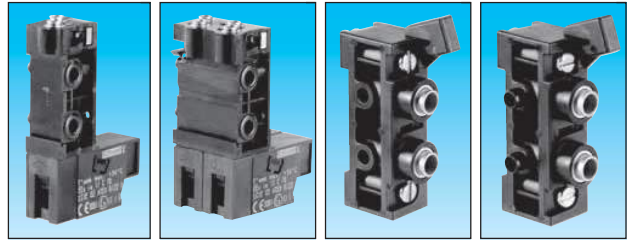

Type		17.5 sub-base	35 sub-base	17.5 end bases	17.5 intermediate supply module
Outer tube Ø	4 mm	81 513 075	81 517 106	—	—
	6 mm	81 513 076	81 517 206	—	81 513 039
Width	mm	17.5	35	2 x 17.5	17.5
Classification		CE II 1 G Ex ia II C T6		CE II 2 GD c II B T6X	

Characteristics

Permitted fluids	lubricated (ASTM2) or not	Air or inert gases			
Working pressure	(bars)	3 at 8			
Temperature	operating (°C)	- 10 at + 50			
	fluid (°C)	-10 at + 30			
Sub-base fixing		Clips		Screws	
Fixing	on support using rail EN 50022 - 35 mm wide	●	●	●	●
Construction	NBR, flame-retarded PA 66, brass	●	●	●	●
Weight	(g)	55	110	86	44
Degree of protection		IP20			

Connections

Pneumatic



- 2 - Output active when de-energized for 3/2 NO or 4/2 17.5 mm
- 4 - Output active when energized for 3/2 NC or 4/2 17.5 mm

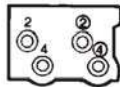

- ② - Output active when de-energized for 4/2 35 mm
- ④ - not used in this case

81 513 040 - 81 513 039

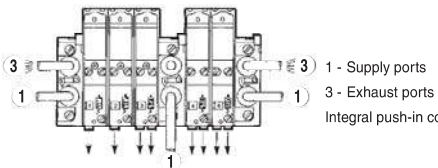

- 1 - Supply ports
 - 3 - Exhaust ports
- Integral push-in connectors

Note:

Each sub-base can be fitted with:
 - 81 513 075-076 sub-base: one 3/2 or 4/2 valve, 17.5 mm wide.
 - 81 517 106-206 sub-base: one 4/2 bistable valve, 35 mm wide or two 3/2 or 4/2 valves, 17.5 mm wide.

Electrical



- A1 - Control signal
- A2 - Common

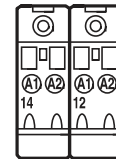

- A1 - Operated control signal (14)
- A2 - Common
- A1 - Rest control signal (12)
- A2 - Common

These sub-bases must be connected individually to an approved safety barrier (see recommended barriers and interfaces page 7).

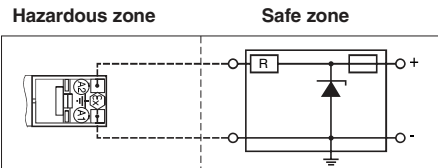

- A1 = - terminal
- A2 = + terminal

Sub-base for intrinsic safety miniature solenoid valve

Dimensions

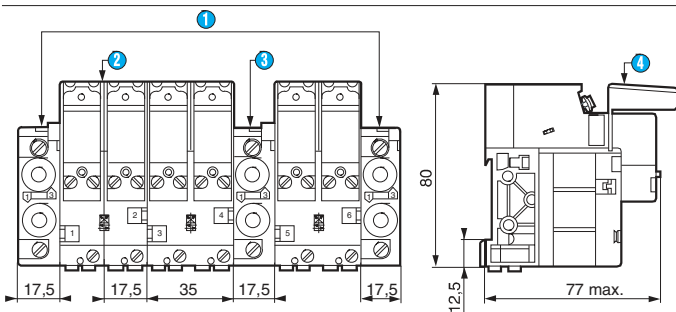

- 1 End bases - one pairs
- 2 Assembly of solenoid valve + valve module
- 3 Intermediary supply module
- 4 Display module

To order an Ex product, you must complete the form on page 53.

Accessories

→ For LED indicator and connector:

LCIE notification
no. LCIE 03 ATEX Q8002

Equipment for use with miniature solenoid valves according to
CE Type Examination Certificate LCIE 02 ATEX 6122X

FILE No. C.PN.HOM.00004.FR
INERIS No. 17564/04
for 79 453 569 and 81 516 093

Equipment intended for use in potentially explosive
atmospheres conforming to Directive 94/9/EC

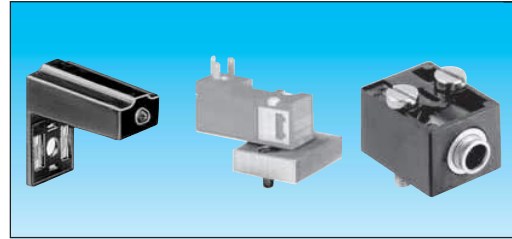

Type		LED indicator	CNOMO adapter	Pneumatic pilot
Power supply	24 V - 50-60 Hz ~	81 513 052	—	—
Electrical connection for solenoid valve		—	—	—
CNOMO 05-8 footprint		—	79 453 569	—
Push-in connector Ø 4 ext.		—	—	81 516 093
Classification		CE Ex II 1 GD Ex ia CT6	—	CE Ex II 2 GD c II BT6X

Diagram

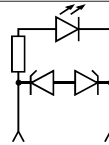

Characteristics

For mounting between the pilot solenoid valve and the module body		•	—	—
Sold in packs	of 5 pieces	•	—	—
	of 10 pieces	—	—	—
Fixing		—	2 M4x10 screws	2 M3x16 screws
Weight	(g)	6	5	5
Operating temperature	(°C)	-5 +50	-5 +50	-5 +50

Dimensions

81 513 052

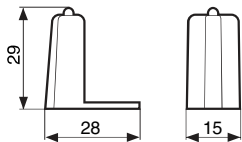

81 516 093

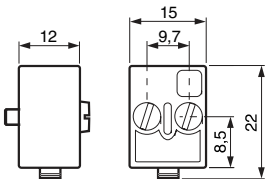

79 453 569

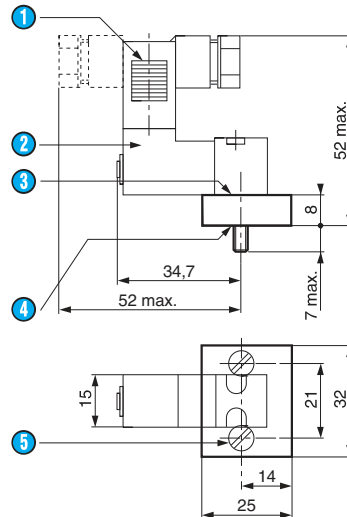

- ① Connector part no. 81 516 082 (with 4 possible positions)
- ② Miniature solenoid valve 81 519 etc
- ③ CNOMO E 06-36-12ON footprint for mounting miniature solenoid valve 81 519
- ④ Mounting on CNOMO 06-05-80/NF E 49-066 footprint

To order an Ex product, you must complete the form on page 53.