

BSS123LT1

Preferred Device

Power MOSFET 170 mAmps, 100 Volts

N-Channel SOT-23

Features

- Pb-Free Packages are Available

MAXIMUM RATINGS

Rating	Symbol	Value	Unit
Drain-Source Voltage	V_{DSS}	100	Vdc
Gate-Source Voltage	V_{GS}	± 20	Vdc
– Continuous	V_{GS}	± 40	Vpk
– Non-repetitive ($t_p \leq 50 \mu s$)			
Drain Current	I_D	0.17	Adc
– Continuous (Note 1)	I_{DM}	0.68	
– Pulsed (Note 2)			

Maximum ratings are those values beyond which device damage can occur. Maximum ratings applied to the device are individual stress limit values (not normal operating conditions) and are not valid simultaneously. If these limits are exceeded, device functional operation is not implied, damage may occur and reliability may be affected.

THERMAL CHARACTERISTICS

Characteristic	Symbol	Max	Unit
Total Device Dissipation FR-5 Board (Note 3) $T_A = 25^\circ C$ Derate above $25^\circ C$	P_D	225 1.8	mW mW/ $^\circ C$
Thermal Resistance, Junction-to-Ambient	$R_{\theta JA}$	556	$^\circ C/W$
Junction and Storage Temperature	T_J, T_{stg}	-55 to +150	$^\circ C$

- The Power Dissipation of the package may result in a lower continuous drain current.
- Pulse Width $\leq 300 \mu s$, Duty Cycle $\leq 2.0\%$.
- FR-5 = $1.0 \times 0.75 \times 0.062$ in.



ON Semiconductor®

<http://onsemi.com>

170 mAmps
100 VOLTS

$R_{DS(on)} = 6 \Omega$

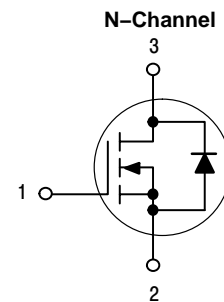

MARKING DIAGRAM

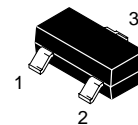

SOT-23
CASE 318
STYLE 21

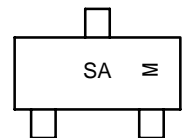

SA = Device Code
M = Date Code

PIN ASSIGNMENT

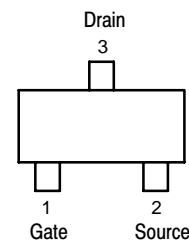

ORDERING INFORMATION

See detailed ordering and shipping information in the package dimensions section on page 2 of this data sheet.

Preferred devices are recommended choices for future use and best overall value.

BSS123LT1

ELECTRICAL CHARACTERISTICS ($T_A = 25^\circ\text{C}$ unless otherwise noted)

Characteristic	Symbol	Min	Typ	Max	Unit
OFF CHARACTERISTICS					
Drain–Source Breakdown Voltage ($V_{GS} = 0, I_D = 250 \mu\text{Adc}$)	$V_{(BR)DSS}$	100	–	–	Vdc
Zero Gate Voltage Drain Current ($V_{GS} = 0, V_{DS} = 100 \text{ Vdc}$)	I_{DSS}	–	–	15 60	μAdc
Gate–Body Leakage Current ($V_{GS} = 20 \text{ Vdc}, V_{DS} = 0$)	I_{GSS}	–	–	50	nAdc

ON CHARACTERISTICS (Note 4)

Gate Threshold Voltage ($V_{DS} = V_{GS}, I_D = 1.0 \text{ mAdc}$)	$V_{GS(th)}$	0.8	–	2.8	Vdc
Static Drain–Source On–Resistance ($V_{GS} = 10 \text{ Vdc}, I_D = 100 \text{ mAdc}$)	$r_{DS(on)}$	–	5.0	6.0	Ω
Forward Transconductance ($V_{DS} = 25 \text{ Vdc}, I_D = 100 \text{ mAdc}$)	g_{fs}	80	–	–	mmhos

DYNAMIC CHARACTERISTICS

Input Capacitance ($V_{DS} = 25 \text{ Vdc}, V_{GS} = 0, f = 1.0 \text{ MHz}$)	C_{iss}	–	20	–	pF
Output Capacitance ($V_{DS} = 25 \text{ Vdc}, V_{GS} = 0, f = 1.0 \text{ MHz}$)	C_{oss}	–	9.0	–	pF
Reverse Transfer Capacitance ($V_{DS} = 25 \text{ Vdc}, V_{GS} = 0, f = 1.0 \text{ MHz}$)	C_{rss}	–	4.0	–	pF

SWITCHING CHARACTERISTICS(4)

Turn–On Delay Time	($V_{CC} = 30 \text{ Vdc}, I_C = 0.28 \text{ Adc},$ $V_{GS} = 10 \text{ Vdc}, R_{GS} = 50 \Omega$)	$t_{d(on)}$	–	20	–	ns
Turn–Off Delay Time		$t_{d(off)}$	–	40	–	ns

REVERSE DIODE

Diode Forward On–Voltage ($I_D = 0.34 \text{ Adc}, V_{GS} = 0 \text{ Vdc}$)	V_{SD}	–	–	1.3	V
----------------------------------------------------------------------------------	----------	---	---	-----	---

4. Pulse Test: Pulse Width $\leq 300 \mu\text{s}$, Duty Cycle $\leq 2.0\%$.

ORDERING INFORMATION

Device	Package	Shipping†
BSS123LT1	SOT–23	3,000 Tape & Reel
BSS123LT1G	SOT–23 (Pb–Free)	3,000 Tape & Reel
BSS123LT3	SOT–23	10,000 Tape & Reel
BSS123LT3G	SOT–23 (Pb–Free)	10,000 Tape & Reel

†For information on tape and reel specifications, including part orientation and tape sizes, please refer to our Tape and Reel Packaging Specifications Brochure, BRD8011/D.

BSS123LT1

TYPICAL ELECTRICAL CHARACTERISTICS

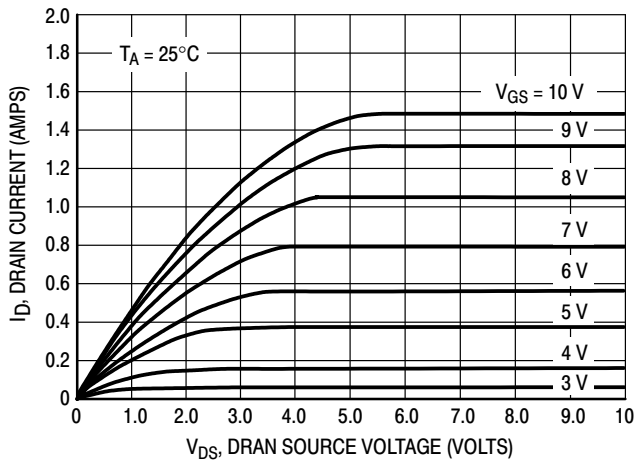

Figure 1. Ohmic Region

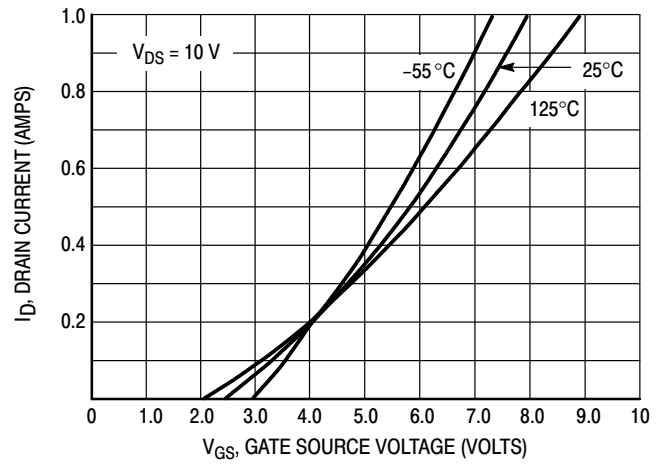

Figure 2. Transfer Characteristics

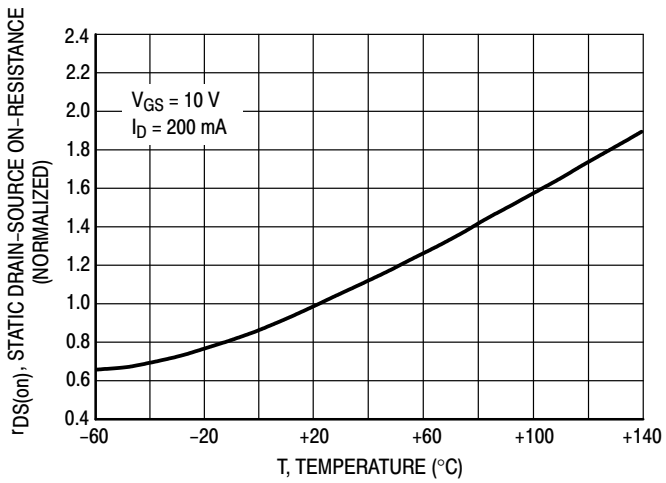

Figure 3. Temperature versus Static Drain-Source On-Resistance

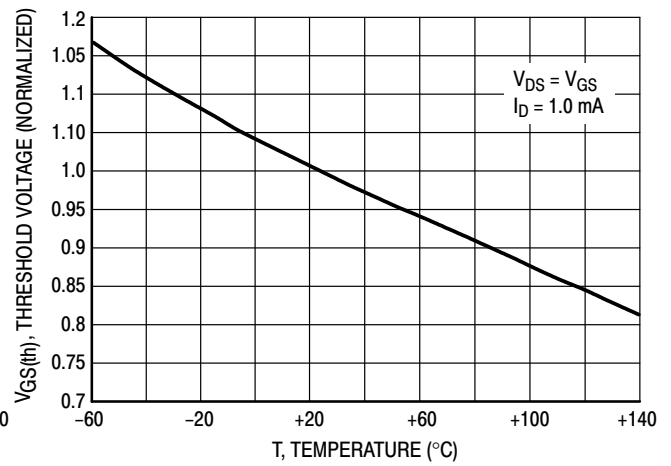
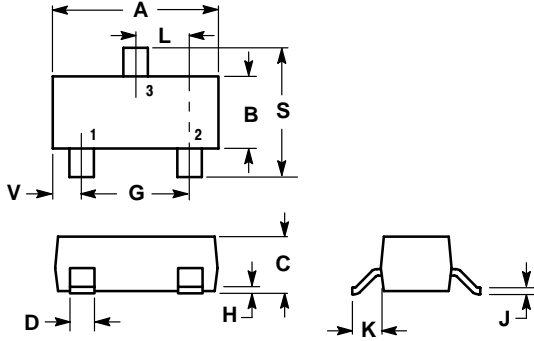

Figure 4. Temperature versus Gate Threshold Voltage

BSS123LT1

PACKAGE DIMENSIONS

**SOT-23
(TO-236)
CASE 318-08
ISSUE AK**



NOTES:

1. DIMENSIONING AND TOLERANCING PER ANSI Y14.5M, 1982.
2. CONTROLLING DIMENSION: INCH.
3. MAXIMUM LEAD THICKNESS INCLUDES LEAD FINISH THICKNESS. MINIMUM LEAD THICKNESS IS THE MINIMUM THICKNESS OF BASE MATERIAL.
4. 318-01 THRU -07 AND -09 OBSOLETE, NEW STANDARD 318-08.

DIM	INCHES		MILLIMETERS	
	MIN	MAX	MIN	MAX
A	0.1102	0.1197	2.80	3.04
B	0.0472	0.0551	1.20	1.40
C	0.0350	0.0440	0.89	1.11
D	0.0150	0.0200	0.37	0.50
G	0.0701	0.0807	1.78	2.04
H	0.0005	0.0040	0.013	0.100
J	0.0034	0.0070	0.085	0.177
K	0.0140	0.0285	0.35	0.69
L	0.0350	0.0401	0.89	1.02
S	0.0830	0.1039	2.10	2.64
V	0.0177	0.0236	0.45	0.60

STYLE 21:

1. GATE
2. SOURCE
3. DRAIN

SOLDERING FOOTPRINT*

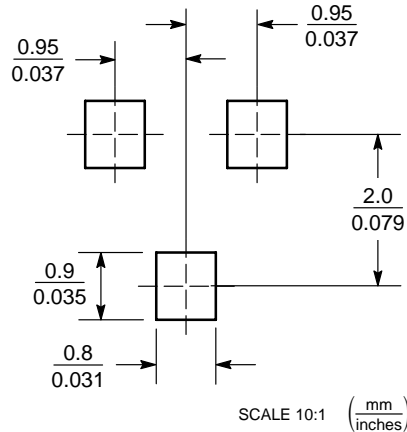

*For additional information on our Pb-Free strategy and soldering details, please download the ON Semiconductor Soldering and Mounting Techniques Reference Manual, SOLDERRM/D.

ON Semiconductor and  are registered trademarks of Semiconductor Components Industries, LLC (SCILLC). SCILLC reserves the right to make changes without further notice to any products herein. SCILLC makes no warranty, representation or guarantee regarding the suitability of its products for any particular purpose, nor does SCILLC assume any liability arising out of the application or use of any product or circuit, and specifically disclaims any and all liability, including without limitation special, consequential or incidental damages. "Typical" parameters which may be provided in SCILLC data sheets and/or specifications can and do vary in different applications and actual performance may vary over time. All operating parameters, including "Typicals" must be validated for each customer application by customer's technical experts. SCILLC does not convey any license under its patent rights nor the rights of others. SCILLC products are not designed, intended, or authorized for use as components in systems intended for surgical implant into the body, or other applications intended to support or sustain life, or for any other application in which the failure of the SCILLC product could create a situation where personal injury or death may occur. Should Buyer purchase or use SCILLC products for any such unintended or unauthorized application, Buyer shall indemnify and hold SCILLC and its officers, employees, subsidiaries, affiliates, and distributors harmless against all claims, costs, damages, and expenses, and reasonable attorney fees arising out of, directly or indirectly, any claim of personal injury or death associated with such unintended or unauthorized use, even if such claim alleges that SCILLC was negligent regarding the design or manufacture of the part. SCILLC is an Equal Opportunity/Affirmative Action Employer. This literature is subject to all applicable copyright laws and is not for resale in any manner.

PUBLICATION ORDERING INFORMATION

LITERATURE FULFILLMENT:

Literature Distribution Center for ON Semiconductor
P.O. Box 611312, Phoenix, Arizona 85082-1312 USA
Phone: 480-829-7710 or 800-344-3860 Toll Free USA/Canada
Fax: 480-829-7709 or 800-344-3867 Toll Free USA/Canada
Email: orderlit@onsemi.com

N. American Technical Support: 800-282-9855 Toll Free USA/Canada

Japan: ON Semiconductor, Japan Customer Focus Center
2-9-1 Kamimeguro, Meguro-ku, Tokyo, Japan 153-0051
Phone: 81-3-5773-3850

ON Semiconductor Website: <http://onsemi.com>

Order Literature: <http://www.onsemi.com/litorder>

For additional information, please contact your local Sales Representative.