

Transfer or duplication of this document as well as the utilisation or communication of its content are not permitted unless express consent is granted. Violations give rise to claims for damages. All rights reserved in case of patent, utility model or design patent registrations.

- Technical data**
- Nominal voltage: 300V/15A
PITCH:5.08mm
 - Connection capacity:
AWG 22-12
 - Insulation Withstanding Voltage:
AC 1600V/MIN
 - Insulation Resistance:
1000MΩ or more at DC500V
 - Tightening torque:
4.3 Lb-in (0.5N.m/5.0kgf.cm)
 - Screw thread: M2.5
 - Stripping length: 8-9mm
 - Operating temperature range:-40°C ~ 115°C
 - Undimensioned Tolerances:

Dim.L=Px5.08		
Dim.B=(P-1)x5.08		
P= number of poles(2-24)		
0-30mm	±0.15	±0.20
over 30mm-60mm	±0.20	±0.25
over 60mm-90mm	±0.25	±0.30
over 90mm	±0.30	±0.40

10.Safety approval:

11.RoHS Compliance

Part No.: **OSTVMXX5550**

No. of Poles	COLOR
02 2 Poles	0: Black
03 3 Poles	2: Red
...	3: Orange
24 24 Poles	4: Yellow
	5: Green (Standard)
	6: Blue
	8: Grey

ITEM	NAME OF PART	MATERIAL	NOTES	Q"TY		
6	PRESS BLOCK	STEEL	Nonstandard colors Mins could apply	Zn PLATED P		
5	CAGE	STEEL		M2.5x0.45, Zn Plated P		
4	SCREW	STEEL		M2.5x0.45, Zn Plated P		
3	WIRE GUARD	BRONZE (PhBz)		TIN PLATED P		
2	COVER	PA66 UL94V-0		ALL COLOR 1		
1	BODY	PA66 UL94V-0		ALL COLOR 1		
DWG	Marvin Zhang	DATE	2017.05.31	UNITS: MM	SHEET: 1 OF 1	Tolerance
CHK.	Marvin Zhang	DATE	2018.04.16	SCALE: NONE 2:1 (:)	REV.: B	X. ±0.50
APP.		DATE		TITLE: OSTVM 5.08 Series "-" slot Screw W/o flange		X.X ±0.30
				PART NO. OSTVMXX5550		X* ±1.0
				DWG NO. OSTVMXX5550.dwg		±1°

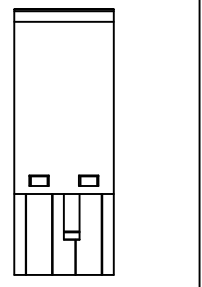
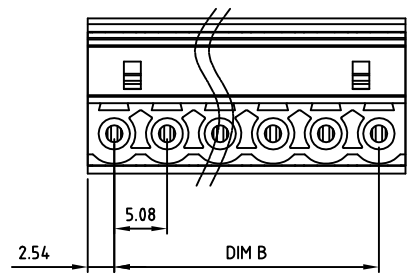
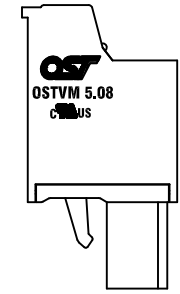
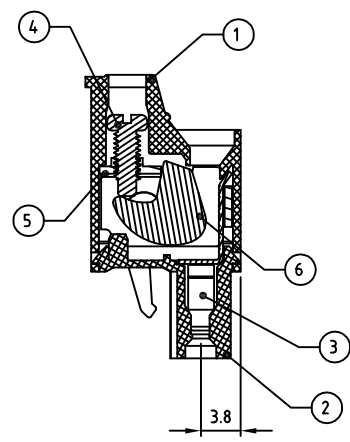
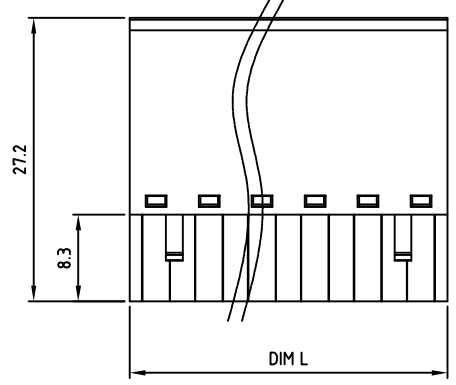
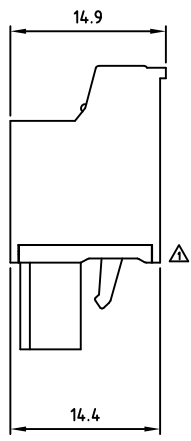
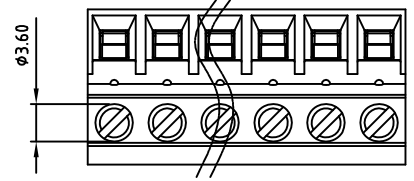

2p Hook

	移出台阶，变更为低背式。	WF.Z	4/16'18
SIGN	DESCRIPTION	CHK.	DATE



ON-SHORE TECHNOLOGY, INC. DWG NO. OSTVMXX5550.dwg