

Features and Benefits

- Compliant with ESA specifications 3401/072
- Standard and Haloring variant
- Ultra-light weight
- Solid fully machined aluminium alloy material
- Non-Magnetic
- EMI application

Typical Applications

- Space equipment
- Satellites harnesses

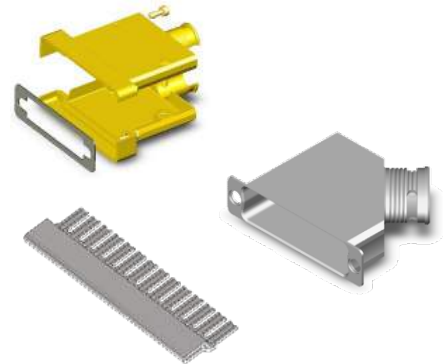

Specification

- High performance D-SUB Lightweight Backshell ESA qualified, for space applications.
- Compliant to ESCC 3401/072 Lightweight Backshells specification for rectangular connectors ESCC 3401/001 and ESCC 3401/002.
- Suitable for use in Space, and high performance military/ aerospace applications: Board to Cable or Cable to Cable applications.
- Shell sizes available: E, A, B, C, D and F
- 3 variants:
 - Standard Lightweight Backshell
 - Lightweight Backshell for EMI Application
 - Lightweight Backshell Haloring Compatible

Quality Level

- ESA/ESCC: code 3401 (Flying model).
- Qualification reviewed every 2 years.

Options

- Haloring – Be ordered separately.
- Male screwlock with clip - Be ordered separately.

Packaging

- Individual packaging.
- Traceability associated as per ESA/ESCC specifications.

Characteristics



CHARACTERISTIC	SPECIFICATION
Operating temperature range	-55/+125 °C
Storage temperature range	-55/+125 °C
Residual Magnetism Level	200 Gamma max.

MATERIALS & FINISHES

COMPONENT	MATERIAL	FINISH
Backshell	Aluminium Alloy 6061-T6	Code A174: 25.4 µm min. electroless Nickel No code: 0.7 µm min. Gold over 25.4 µm min. electroless Nickel
Haloring	Copper Alloy	5µm min. Silver
Screws	Brass	0.7 µm Gold over 1 µm min. Cu
EMI Gasket	Silicone conductive elastomer	None

PRODUCT LIST

STANDARD LIGHTWEIGHT BACKSHELL

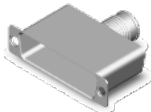
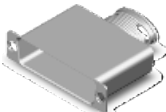
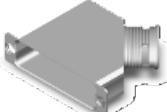
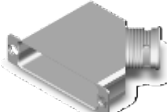
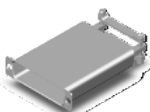
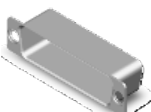
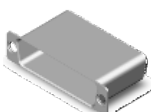
		
90° Circular Right Outlet Page 4	90° Circular Left Outlet Page 5	Top Circular Outlet Page 6
		
Top Elliptical Outlet Page 7	45° Elliptical Right Outlet Page 8	45° Elliptical Left Outlet Page 9
		
Saddle Clamp Top Outlet Page 10	Closed Extra Shorting Can Page 11	Closed Shorting Can Page 12

LIGHTWEIGHT BACKSHELL - EMI APPLICATION

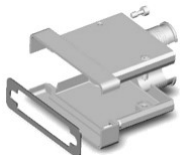
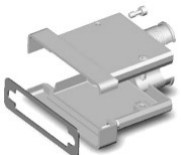
	
Top Cylindrical Outlet - Rear Mounting Page 14	Top Cylindrical Outlet - Front Mounting Page 16

LIGHTWEIGHT BACKSHELLS - HALORING COMPATIBLE AND HALORING

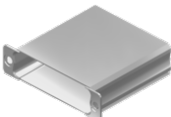
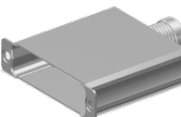
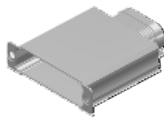
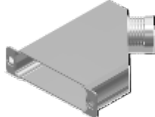
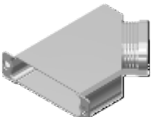
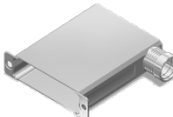
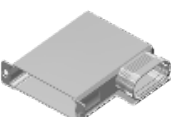
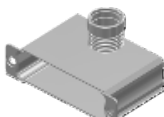
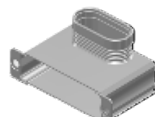
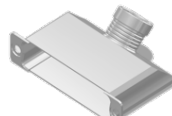
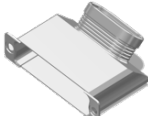
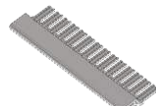
		
Closed Shorting Can Page 19	Top Circular Outlet Page 20	Top Elliptical Outlet Page 21
		
45° Circular Outlet Page 22	45° Elliptical Outlet Page 23	90° Circular Outlet Page 24
		
90° Elliptical Outlet Page 25	90° Top Circular Outlet Page 26	90° Top Elliptical Outlet Page 27
		
45° Top Circular Outlet Page 28	45° Top Elliptical Outlet Page 29	Haloring Page 30

STANDARD BACKSHELL LIGHTWEIGHT

D-Sub Lightweight Backshell
90° Circular - Right Outlet
(Our design accepts right or left mounting)

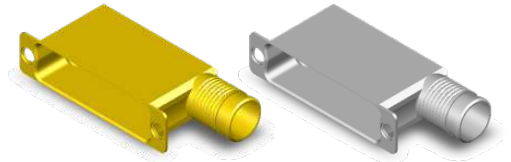

DIMENSIONS & WEIGHT

		Value							Weight (grams)
		A ±0.2	B ±0.15	C ±0.13	D ±0.50	E ±0.15	F ±0.15	G ±0.50	
Shell Size	E	30.68	12.50	24.99	40.60	7.00	9.00	25.40	7
	A	39.01	12.50	33.32	49.00	10.00	12.00	25.40	10
	B	52.91	12.50	47.04	62.70	10.50	12.50	25.40	13.5
	C	69.19	12.50	63.50	79.20	10.50	12.50	25.40	18
	D	66.80	15.30	61.11	76.70	13.30	15.30	25.40	23
	F	69.30	17.30	63.50	79.90	15.30	17.30	35.40	28

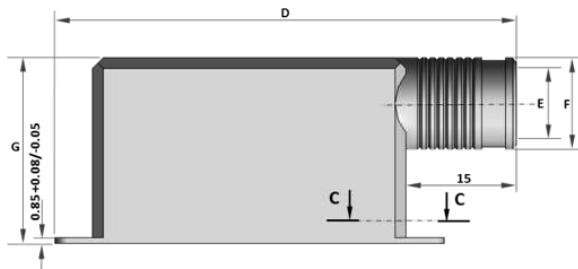

Detail B-B

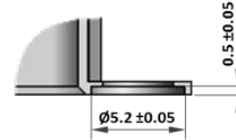

Configuration Sizes E-A-B-C-D

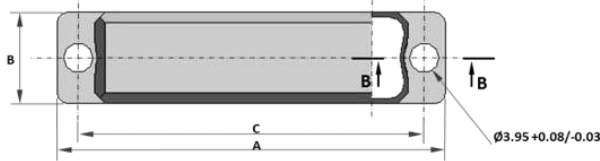

Detail A-A

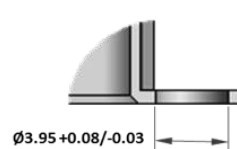

Configuration Size F

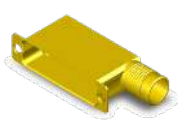

DESCRIPTION & PART NUMBERS

SHELL FINISH	SHELL SIZE	ESA/ESCC DESCRIPTION	C&K PART NUMBER
 Electroless Nickel	E	340107225B NMBA-A174	C115366-2606D
	A	340107226B NMBA-A174	C115366-2607D
	B	340107227B NMBA-A174	C115366-2608D
	C	340107228B NMBA-A174	C115366-2609D
	D	340107229B NMBA-A174	C115366-2610D
	F	340107276B NMB-A174	C115366-2691D
 Gold	E	340107225B NMBA	C115366-2606C
	A	340107226B NMBA	C115366-2607C
	B	340107227B NMBA	C115366-2608C
	C	340107228B NMBA	C115366-2609C
	D	340107229B NMBA	C115366-2610C
	F	340107276B NMB	C115366-2691C



Dimensions shown in: mm
 Specifications and dimensions subject to change

D-Sub Lightweight Backshell
90° Circular - Left Outlet
(Our design accepts right or left mounting)

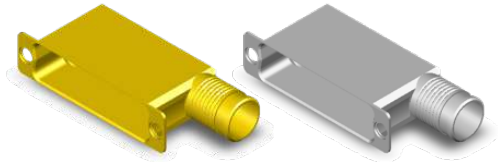

DIMENSIONS & WEIGHT

		Value							Weight (grams)
		A ±0.2	B ±0.15	C ±0.13	D ±0.50	E ±0.15	F ±0.15	G ±0.50	
Shell Size	E	30.68	12.50	24.99	40.60	7.00	9.00	25.40	7
	A	39.01	12.50	33.32	49.00	10.00	12.00	25.40	10
	B	52.91	12.50	47.04	62.70	10.50	12.50	25.40	13.5
	C	69.19	12.50	63.50	79.20	10.50	12.50	25.40	18
	D	66.80	15.30	61.11	76.70	13.30	15.30	25.40	23
	F	69.30	17.30	63.50	79.90	15.30	17.30	35.40	28

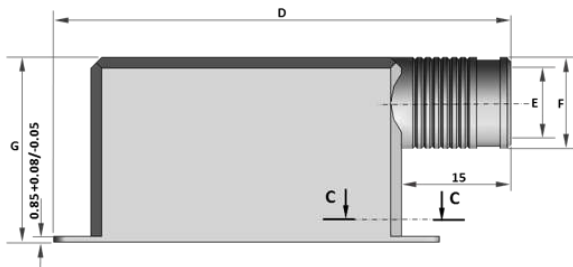

Configuration Sizes E-A-B-C-D

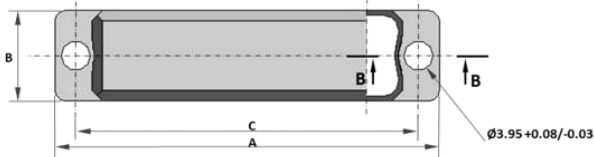

Configuration Size F



Detail B-B

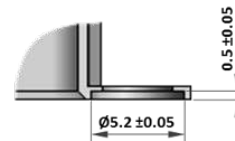

Detail A-A

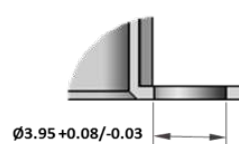

DESCRIPTION & PART NUMBERS

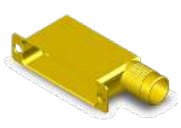
SHELL FINISH	SHELL SIZE	ESA/ESCC DESCRIPTION	C&K PART NUMBER
 Electroless Nickel	E	340107225B NMBA-A174	C115366-2606D
	A	340107226B NMBA-A174	C115366-2607D
	B	340107227B NMBA-A174	C115366-2608D
	C	340107228B NMBA-A174	C115366-2609D
	D	340107229B NMBA-A174	C115366-2610D
	F	340107276B NMB-A174	C115366-2691D
 Gold	E	340107225B NMBA	C115366-2606C
	A	340107226B NMBA	C115366-2607C
	B	340107227B NMBA	C115366-2608C
	C	340107228B NMBA	C115366-2609C
	D	340107229B NMBA	C115366-2610C
	F	340107276B NMB	C115366-2691C

Dimensions shown in: mm
 Specifications and dimensions subject to change

D-Sub Lightweight Backshell Top Circular Outlet

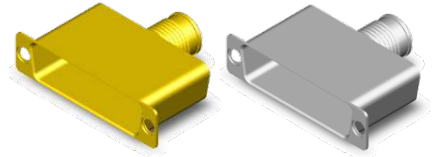

DIMENSIONS & WEIGHT

		Value					Weight (grams)
		A ±0.2	B ±0.15	C ±0.13	D ±0.20	E ±0.15	
Shell Size	E	30.68	12.50	24.99	7.00	9.00	6.5
	A	39.01	12.50	33.32	10.00	12.00	8.5
	B	52.91	12.50	47.04	10.50	12.50	11.5
	C	69.19	12.50	63.50	10.50	12.50	13.5
	D	66.80	15.30	61.11	13.30	15.30	14.5
	F	69.30	17.30	63.50	15.30	17.30	16.5

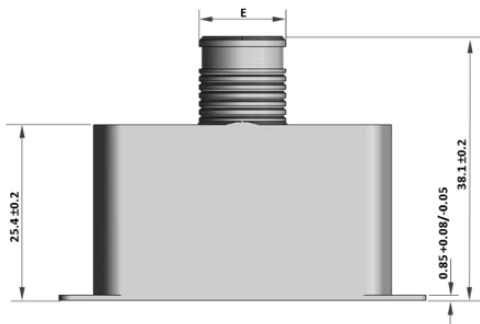

Configuration Sizes E-A-B-C-D

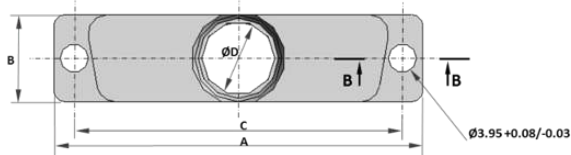

Configuration Size F

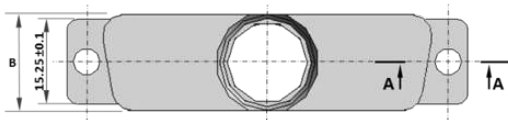

Detail B-B

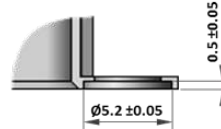

Detail A-A

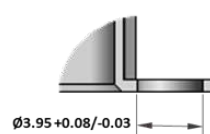

DESCRIPTION & PART NUMBERS

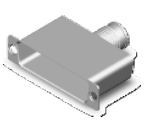
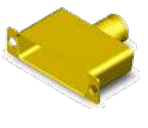
SHELL FINISH	SHELL SIZE	ESA/ESCC DESCRIPTION	C&K PART NUMBER
 Electroless Nickel	E	340107235B NMBA-A174	C115366-2616D
	A	340107236B NMBA-A174	C115366-2617D
	B	340107237B NMBA-A174	C115366-2618D
	C	340107238B NMBA-A174	C115366-2619D
	D	340107239B NMBA-A174	C115366-2620D
	F	340107277B NMB-A174	C115366-2692D
 Gold	E	340107235B NMBA	C115366-2616C
	A	340107236B NMBA	C115366-2617C
	B	340107237B NMBA	C115366-2618C
	C	340107238B NMBA	C115366-2619C
	D	340107239B NMBA	C115366-2620C
	F	340107277B NMB	C115366-2692C



Dimensions shown in: mm
Specifications and dimensions subject to change

D-Sub Lightweight Backshell Top Elliptical Outlet

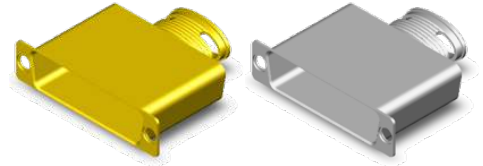

DIMENSIONS & WEIGHT

		Value					Weight (grams)
		A ±0.2	B ±0.15	C ±0.13	D ±0.38	E ±0.15	
Shell Size	E	30.68	12.50	24.99	12.70	9.50	8
	A	39.01	12.50	33.32	15.87	9.50	13
	B	52.91	12.50	47.04	19.05	9.50	18
	C	69.19	12.50	63.50	25.40	9.50	23
	D	66.80	15.30	61.11	22.22	12.30	28
	F	69.30	17.30	63.50	32.00	14.30	33

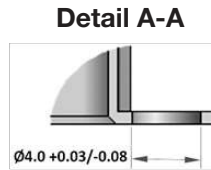
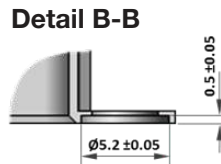
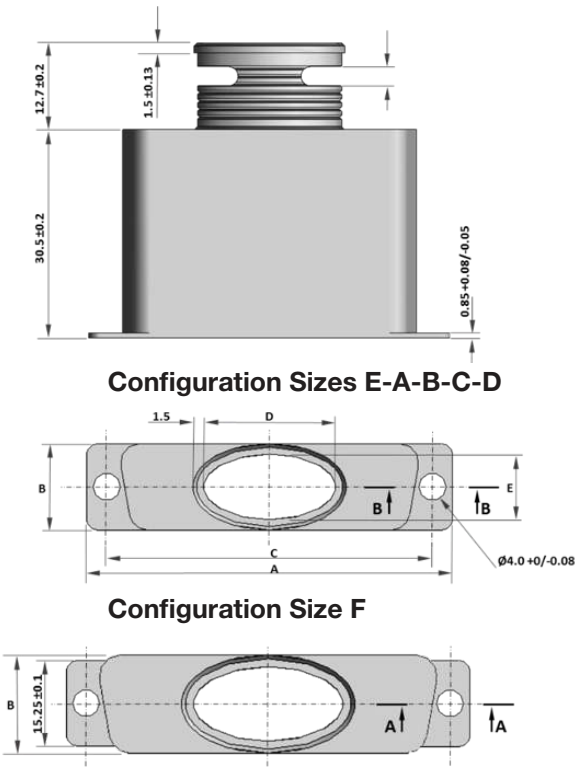

DESCRIPTION & PART NUMBERS

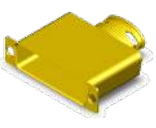
SHELL FINISH	SHELL SIZE	ESA/ESCC DESCRIPTION	C&K PART NUMBER
 Electroless Nickel	E	340107246B NMBA-A174	C115366-2622D
	A	340107247B NMBA-A174	C115366-2623D
	B	340107248B NMBA-A174	C115366-2624D
	C	340107249B NMBA-A174	C115366-2625D
	D	340107250B NMBA-A174	C115366-2626D
	F	340107278B NMB-A174	C115366-2693D
 Gold	E	340107246B NMBA	C115366-2622C
	A	340107247B NMBA	C115366-2623C
	B	340107248B NMBA	C115366-2624C
	C	340107249B NMBA	C115366-2625C
	D	340107250B NMBA	C115366-2626C
	F	340107278B NMB	C115366-2693C

Dimensions shown in: mm
Specifications and dimensions subject to change

D-Sub Lightweight Backshell
45° Elliptical - Right Outlet
(Our design accepts right or left mounting)

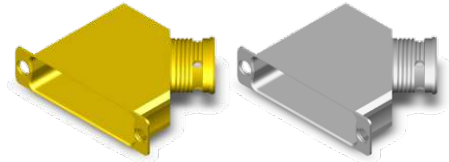

DIMENSIONS & WEIGHT

		Value					Weight (grams)
		A ±0.2	B ±0.15	C ±0.13	D ±0.38	E ±0.15	
Shell Size	E	30.68	12.50	24.99	12.70	9.50	10
	A	39.01	12.50	33.32	15.87	9.50	14
	B	52.91	12.50	47.04	19.05	9.50	20
	C	69.19	12.50	63.50	25.40	9.50	26
	D	66.80	15.30	61.11	22.22	12.30	33
	F	69.30	17.30	63.50	29.00	14.30	40

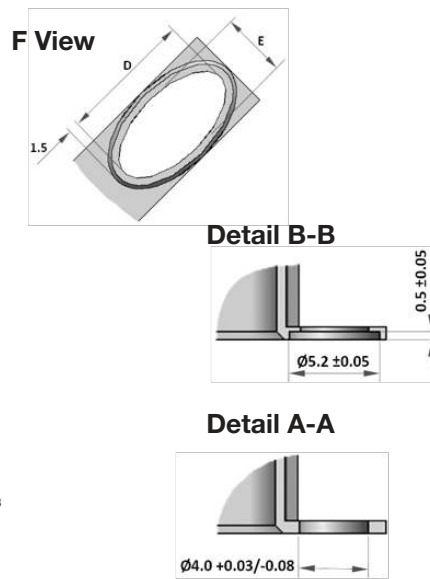
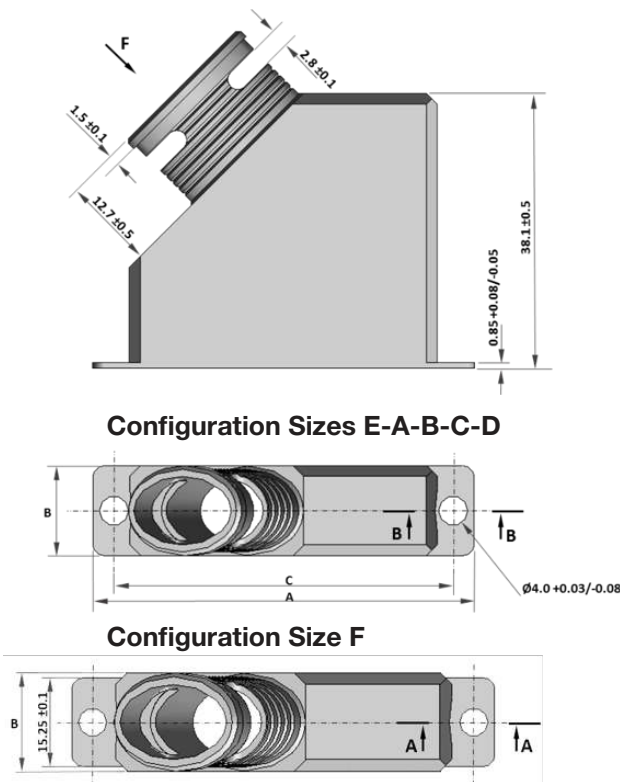

DESCRIPTION & PART NUMBERS

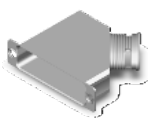
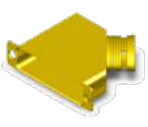
SHELL FINISH	SHELL SIZE	ESA/ESCC DESCRIPTION	C&K PART NUMBER
 Electroless Nickel	E	340107251B NMBA-A174	C115366-2627D
	A	340107252B NMBA-A174	C115366-2628D
	B	340107253B NMBA-A174	C115366-2629D
	C	340107254B NMBA-A174	C115366-2630D
	D	340107255B NMBA-A174	C115366-2631D
	F	340107279B NMB-A174	C115366-2694D
 Gold	E	340107251B NMBA	C115366-2627C
	A	340107252B NMBA	C115366-2628C
	B	340107253B NMBA	C115366-2629C
	C	340107254B NMBA	C115366-2630C
	D	340107255B NMBA	C115366-2631C
	F	340107279B NMB	C115366-2694C



*Dimensions shown in: mm
 Specifications and dimensions subject to change*

D-Sub Lightweight Backshell
45° Elliptical - Left Outlet
(Our design accepts right or left mounting)

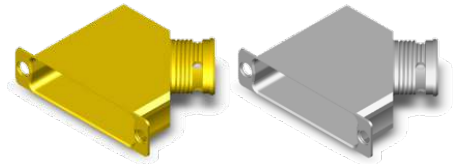

DIMENSIONS & WEIGHT

		Value					Weight (grams)
		A ±0.2	B ±0.15	C ±0.13	D ±0.38	E ±0.15	
Shell Size	E	30.68	12.50	24.99	12.70	9.50	10
	A	39.01	12.50	33.32	15.87	9.50	14
	B	52.91	12.50	47.04	19.05	9.50	20
	C	69.19	12.50	63.50	25.40	9.50	26
	D	66.80	15.30	61.11	22.22	12.30	33
	F	69.30	17.30	63.50	29.00	14.30	40

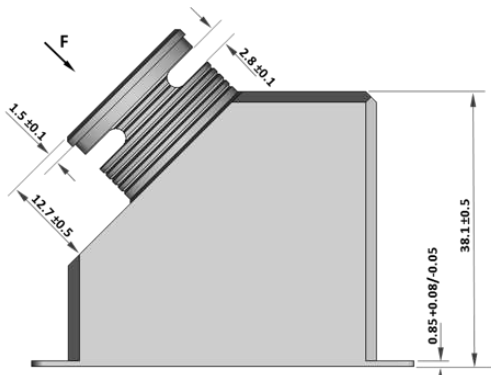

Configuration Sizes E-A-B-C-D

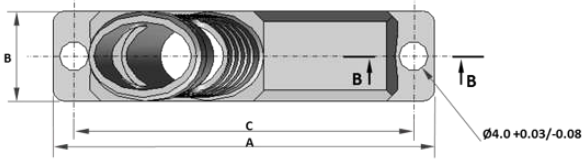

Configuration Size F

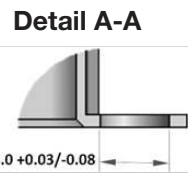
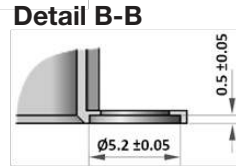
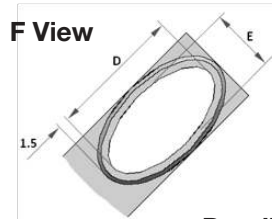
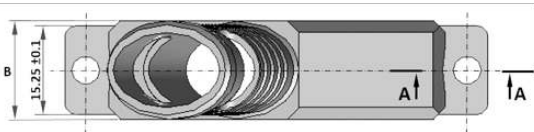

DESCRIPTION & PART NUMBERS

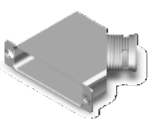
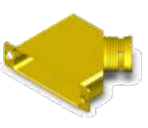
SHELL FINISH	SHELL SIZE	ESA/ESCC DESCRIPTION	C&K PART NUMBER
 Electroless Nickel	E	340107256B NMBA-A174	C115366-2632D
	A	340107257B NMBA-A174	C115366-2633D
	B	340107258B NMBA-A174	C115366-2634D
	C	340107259B NMBA-A174	C115366-2635D
	D	340107260B NMBA-A174	C115366-2636D
	F	340107279B NMB-A174	C115366-2694D
 Gold	E	340107256B NMBA	C115366-2632C
	A	340107257B NMBA	C115366-2633C
	B	340107258B NMBA	C115366-2634C
	C	340107259B NMBA	C115366-2635C
	D	340107260B NMBA	C115366-2636C
	F	340107279B NMB	C115366-2694C

Dimensions shown in: mm
 Specifications and dimensions subject to change



D-Sub Lightweight Backshell Saddle Clamp Top Outlet

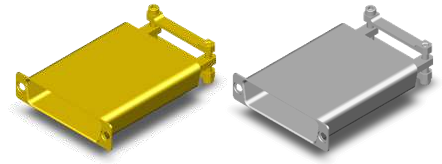

DIMENSIONS & WEIGHT

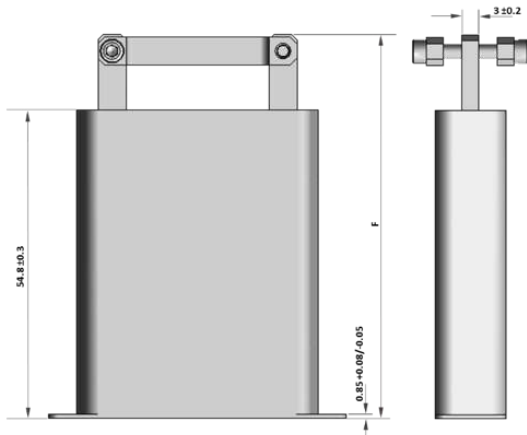

Configuration Sizes E-A-B-C-D

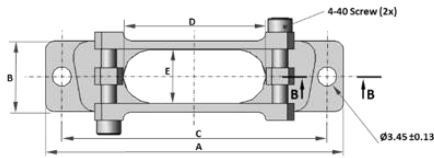

Configuration Size F

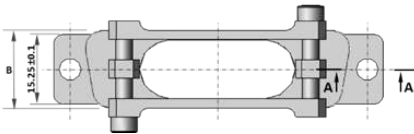

		Value						Weight (grams)
		A ±0.2	B ±0.15	C ±0.13	D ±0.30	E ±0.25	F ±0.5	
Shell Size	E	30.68	12.50	24.99	9.50	9.50	66.75	15.5
	A	39.01	12.50	33.32	18.10	9.50	66.75	19
	B	52.91	12.50	47.04	25.40	9.50	68.35	23
	C	69.19	12.50	63.50	34.90	9.50	68.35	29
	D	66.80	15.30	61.11	35.70	11.90	68.35	33
	F	69.30	17.30	63.50	47.00	13.90	68.35	37

Detail B-B

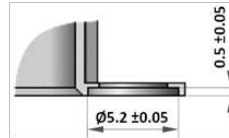

Detail A-A

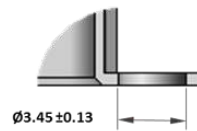

DESCRIPTION & PART NUMBERS

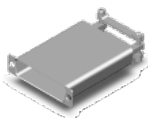
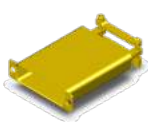
SHELL FINISH	SHELL SIZE	ESA/ESCC DESCRIPTION	C&K PART NUMBER
 Electroless Nickel	E	340107205B NMBA-A174	C115366-2586D
	A	340107206B NMBA-A174	C115366-2587D
	B	340107207B NMBA-A174	C115366-2588D
	C	340107208B NMBA-A174	C115366-2589D
	D	340107209B NMBA-A174	C115366-2590D
	F	340107272B NMB-A174	C115366-2687D
 Gold	E	340107205B NMBA	C115366-2586C
	A	340107206B NMBA	C115366-2587C
	B	340107207B NMBA	C115366-2588C
	C	340107208B NMBA	C115366-2589C
	D	340107209B NMBA	C115366-2590C
	F	340107272B NMB	C115366-2687C



Dimensions shown in: mm
Specifications and dimensions subject to change

D-Sub Lightweight Backshell Closed - Extra Shorting Can

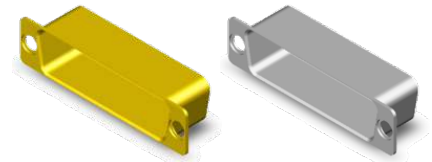

DIMENSIONS & WEIGHT

		Value			
		A ±0.2	B ±0.15	C ±0.13	Weight (grams)
Shell Size	E	30.68	12.50	24.99	8
	A	39.01	12.50	33.32	10
	B	52.91	12.50	47.04	14
	C	69.19	12.50	63.50	20
	D	66.80	15.30	61.11	26
	F	69.30	17.30	63.50	30



Configuration Sizes E-A-B-C-D

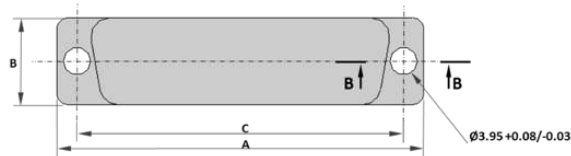

Configuration Size F



Detail B-B

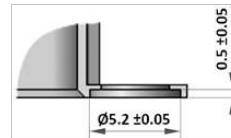

Detail A-A

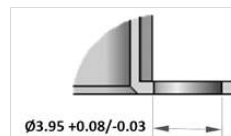

DESCRIPTION & PART NUMBERS

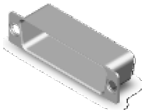
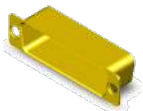
SHELL FINISH	SHELL SIZE	ESA/ESCC DESCRIPTION	C&K PART NUMBER
 Electroless Nickel	E	340107261B NMBA-A174	C115366-2637D
	A	340107262B NMBA-A174	C115366-2638D
	B	340107263B NMBA-A174	C115366-2639D
	C	340107264B NMBA-A174	C115366-2640D
	D	340107265B NMBA-A174	C115366-2641D
	F	340107280B NMB-A174	C115366-2695D
 Gold	E	340107261B NMBA	C115366-2637C
	A	340107262B NMBA	C115366-2638C
	B	340107263B NMBA	C115366-2639C
	C	340107264B NMBA	C115366-2640C
	D	340107265B NMBA	C115366-2641C
	F	340107280B NMB	C115366-2695C

Dimensions shown in: mm
Specifications and dimensions subject to change

D-Sub Lightweight Backshell Closed - Shorting Can

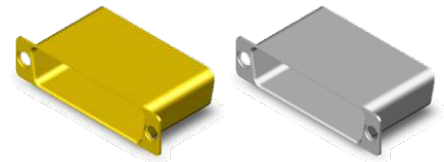

DIMENSIONS & WEIGHT

		Value			Weight (grams)
		A ±0.2	B ±0.15	C ±0.13	
Shell Size	E	30.68	12.50	24.99	8
	A	39.01	12.50	33.32	10
	B	52.91	12.50	47.04	14
	C	69.19	12.50	63.50	20
	D	66.80	15.30	61.11	26
	F	69.30	17.30	63.50	30



Configuration Sizes E-A-B-C-D

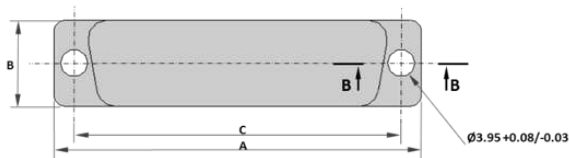

Configuration Size F



Detail B-B

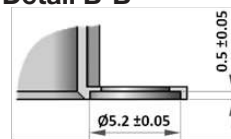

Detail A-A

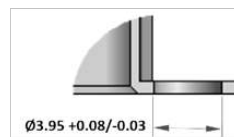

DESCRIPTION & PART NUMBERS

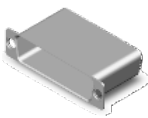
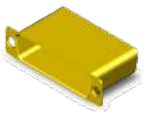
SHELL FINISH	SHELL SIZE	ESA/ESCC DESCRIPTION	C&K PART NUMBER
 Electroless Nickel	E	340107210B NMBA-A174	C115366-2591D
	A	340107211B NMBA-A174	C115366-2592D
	B	340107212B NMBA-A174	C115366-2593D
	C	340107213B NMBA-A174	C115366-2594D
	D	340107214B NMBA-A174	C115366-2595D
	F	340107273B NMB-A174	C115366-2688D
 Gold	E	340107210B NMBA	C115366-2591C
	A	340107211B NMBA	C115366-2592C
	B	340107212B NMBA	C115366-2593C
	C	340107213B NMBA	C115366-2594C
	D	340107214B NMBA	C115366-2595C
	F	340107273B NMB	C115366-2688C



Dimensions shown in: mm
Specifications and dimensions subject to change

EMI BACKSHELL LIGHTWEIGHT

**D-Sub Lightweight Backshell
Top Cylindrical Outlet - EMI Application
Rear Mounting**

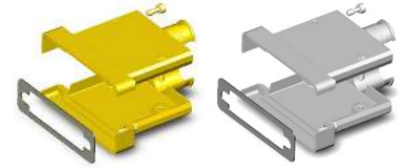

DIMENSIONS & WEIGHT

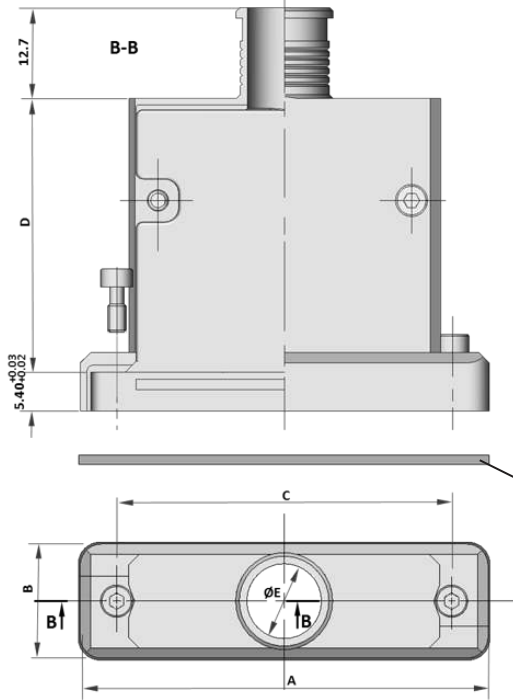

		Value					Weight (grams)
		A ±0.25	B ±0.25	C ±0.13	D ±0.30	E ±0.25	
Shell Size	E	35.03	15.98	24.99	32.70	6.73	21
	A	43.36	15.98	33.32	32.70	9.90	26
	B	57.25	15.98	47.04	38.30	10.54	30
	C	73.53	15.98	63.50	38.30	10.54	35
	D	71.14	18.75	61.11	38.30	13.33	40
	F	73.50	20.80	63.50	38.30	15.40	45

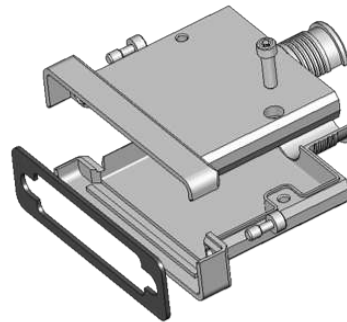

EMI Gaskets (3x):

- 1.40±0.1mm - to use with panel thickness within 0.77mm and 1.16mm
- 1.00±0.1mm - to use with panel thickness within 1.16mm and 1.55mm
- 0.60±0.1mm - to use with panel thickness within 1.55mm and 1.98mm

Backshell delivered with:

- 3 EMI gaskets to use according to panel thickness
- 2 Jackscrews 4-40 NC 2A Hexagonal Hole Head
- 2 screwlocks to fix the shells

DESCRIPTION & PART NUMBERS

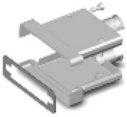
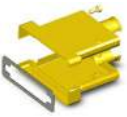
SHELL FINISH	SHELL SIZE	ESA/ESCC DESCRIPTION	C&K PART NUMBER
 Electroless Nickel	E	340107220B NMBA-A174	C115366-2601D
	A	340107221B NMBA-A174	C115366-2602D
	B	340107222B NMBA-A174	C115366-2603D
	C	340107223B NMBA-A174	C115366-2604D
	D	340107224B NMBA-A174	C115366-2605D
	F	340107275B NMB-A174	C115366-2690D
 Gold	E	340107220B NMBA	C115366-2601C
	A	340107221B NMBA	C115366-2602C
	B	340107222B NMBA	C115366-2603C
	C	340107223B NMBA	C115366-2604C
	D	340107224B NMBA	C115366-2605C
	F	340107275B NMB	C115366-2690C



Dimensions shown in: mm
Specifications and dimensions subject to change

D-Sub Lightweight Backshell
Top Cylindrical Outlet - EMI Application
Rear Mounting

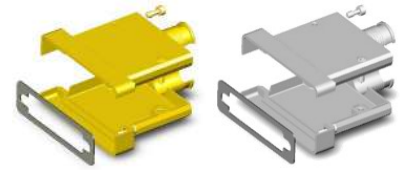

MOUNTING RECOMMENDATION - Panel Thickness within 0.77mm and 1.16mm

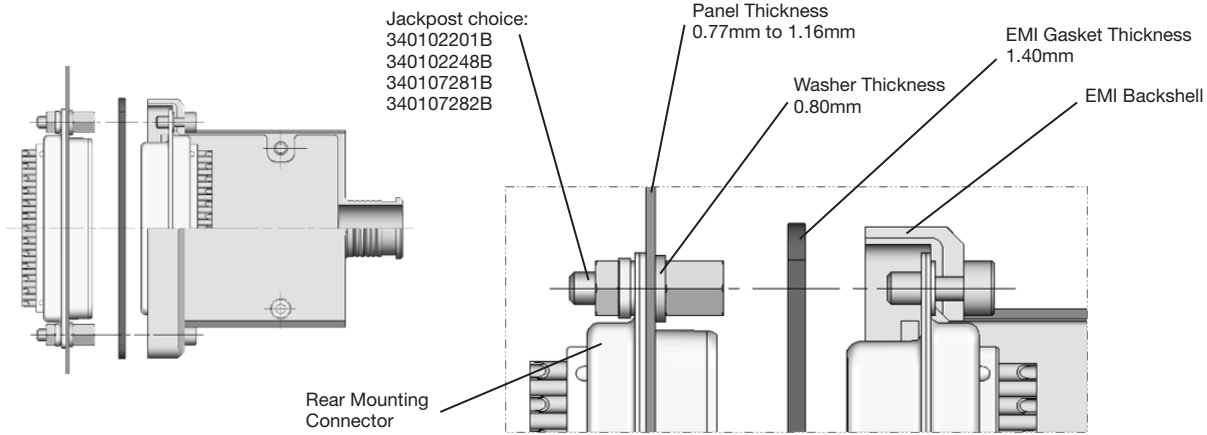

MOUNTING RECOMMENDATION - Panel Thickness within 1.16mm and 1.55mm

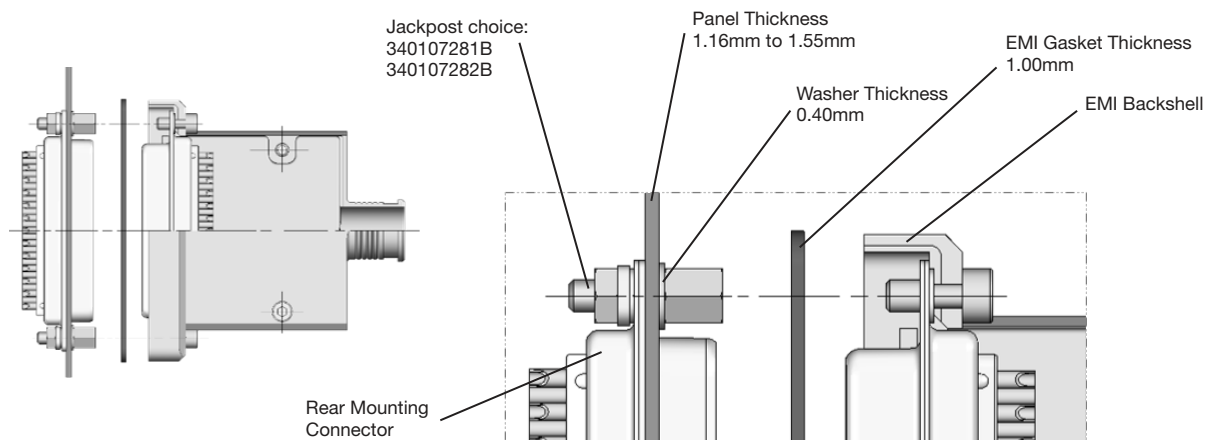

MOUNTING RECOMMENDATION - Panel Thickness within 1.55mm and 1.98mm

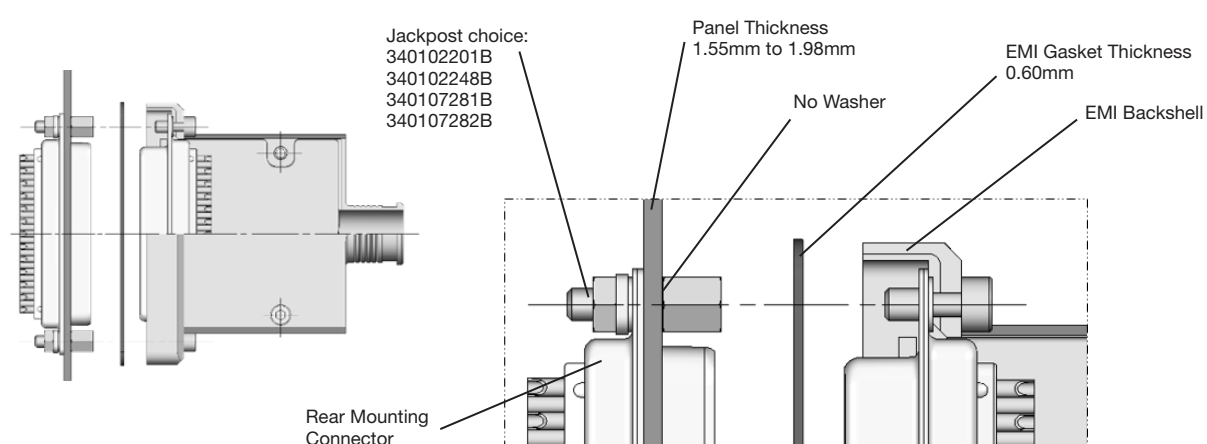

Dimensions shown in: mm
 Specifications and dimensions subject to change

**D-Sub Lightweight Backshell
Top Cylindrical Outlet - EMI Application
Front Mounting**

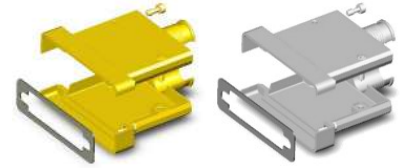

DIMENSIONS & WEIGHT

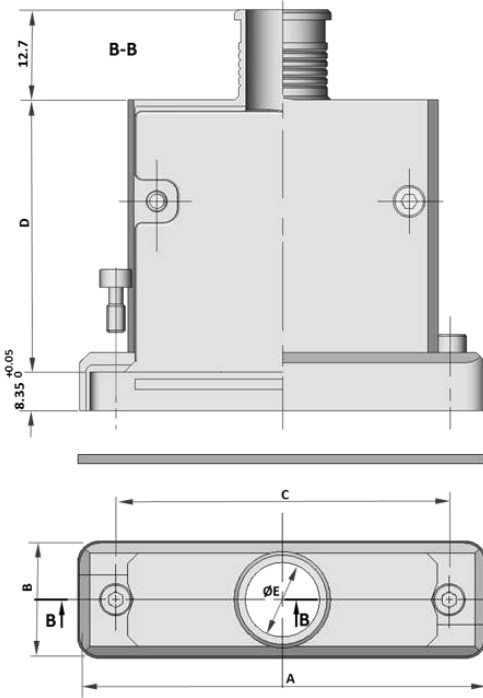

		Value					Weight (grams)
		A ±0.25	B ±0.25	C ±0.13	D ±0.30	E ±0.25	
Shell Size	E	35.03	15.98	24.99	32.70	6.73	21
	A	43.36	15.98	33.32	32.70	9.90	26
	B	57.25	15.98	47.04	38.30	10.54	30
	C	73.53	15.98	63.50	38.30	10.54	35
	D	71.14	18.75	61.11	38.30	13.33	40
	F	73.50	20.80	63.50	38.30	15.40	45

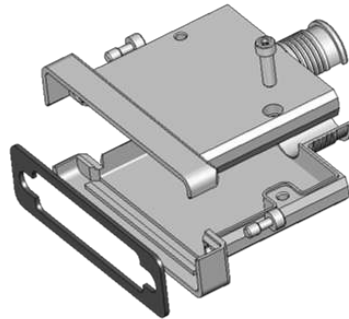



EMI Gaskets:
0.60±0.1mm thickness

Backshell delivered with:

- 1 EMI gasket
- 2 Jackscrews 4-40 NC 2A Hexagonal Hole Head
- 2 screwlocks to fix the shells

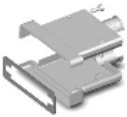
DESCRIPTION & PART NUMBERS

SHELL FINISH	SHELL SIZE	ESA/ESCC DESCRIPTION	C&K PART NUMBER
 Electroless Nickel	E	340107215B NMBA-A174	C115366-2596D
	A	340107216B NMBA-A174	C115366-2597D
	B	340107217B NMBA-A174	C115366-2598D
	C	340107218B NMBA-A174	C115366-2599D
	D	340107219B NMBA-A174	C115366-2600D
	F	340107274B NMB-A174	C115366-2689D
 Gold	E	340107215B NMBA	C115366-2596C
	A	340107216B NMBA	C115366-2597C
	B	340107217B NMBA	C115366-2598C
	C	340107218B NMBA	C115366-2599C
	D	340107219B NMBA	C115366-2600C
	F	340107274B NMB	C115366-2689C



Dimensions shown in: mm
Specifications and dimensions subject to change

**D-Sub Lightweight Backshell
Top Cylindrical Outlet - EMI Application
Front Mounting**

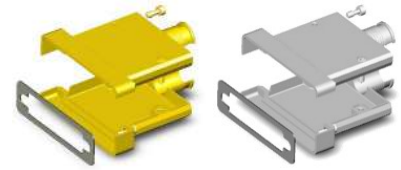

MOUNTING RECOMMENDATION

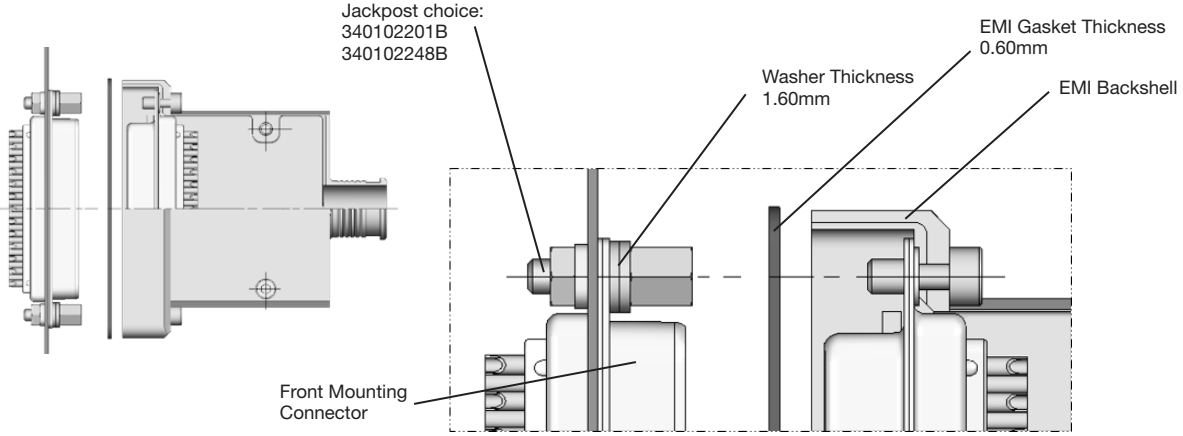

*Dimensions shown in: mm
Specifications and dimensions subject to change*

**BACKSHELL LIGHTWEIGHT
HALORING COMPATIBLE
+
HALORING**

D-Sub Lightweight Backshell
Haloring Compatible
Closed - Shorting Can

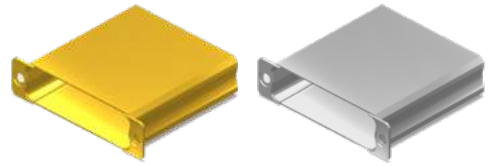

DIMENSIONS & WEIGHT

		Value				Weight (grams)
		M ±0.38	N ±0.2	d ±0.2	L ±0.13	
Shell Size	E	30.56	13.26	12.55	24.99	10.7
	A	38.89	13.26	12.55	33.32	13.5
	B	52.78	13.26	12.55	47.04	18
	C	69.04	13.26	12.55	63.50	23.6
	D	66.67	15.36	15.35	61.11	24.6
	F	69.32	18.06	17.35	63.50	26.2

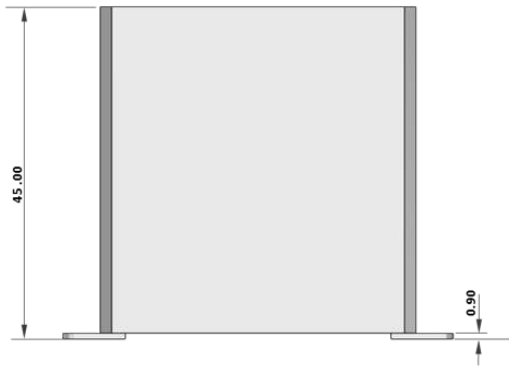

Detail A-A Sizes E, A B, C and D

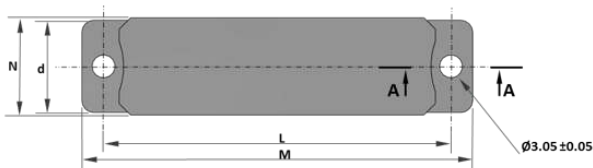
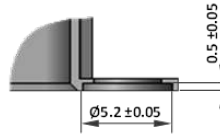

Detail A-A Size F

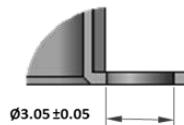

DESCRIPTION & PART NUMBERS

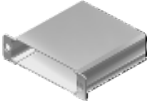
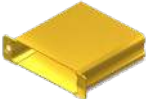
SHELL FINISH	SHELL SIZE	ESA/ESCC DESCRIPTION	C&K PART NUMBER
 Electroless Nickel	E	340107288B NMB-A174	C115366-2932D
	A	340107289B NMB-A174	C115366-2933D
	B	340107290B NMB-A174	C115366-2934D
	C	340107291B NMB-A174	C115366-2935D
	D	340107292B NMB-A174	C115366-2936D
	F	340107293B NMB-A174	C115366-2937D
 Gold	E	340107288B NMB	C115366-2032C
	A	340107289B NMB	C115366-2933C
	B	340107290B NMB	C115366-2934C
	C	340107291B NMB	C115366-2935C
	D	340107292B NMB	C115366-2936C
	F	340107293B NMB	C115366-2937C

Dimensions shown in: mm
 Specifications and dimensions subject to change



D-Sub Lightweight Backshell
Haloring Compatible
Top Circular Outlet

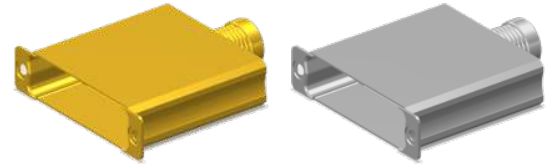

DIMENSIONS & WEIGHT

		Value						Weight (grams)
		M ±0.38	N ±0.2	d ±0.2	L ±0.13	ØB ±0.1	ØC ±0.1	
Shell Size	E	30.56	13.26	12.55	24.99	10.05	13.26	12
	A	38.89	13.26	12.55	33.32	10.05	13.26	14.8
	B	52.78	13.26	12.55	47.04	10.05	13.26	19.3
	C	69.04	13.26	12.55	63.50	10.05	13.26	24.9
	D	66.67	15.36	15.35	61.11	12.85	15.36	26.1
	F	69.32	18.06	17.35	63.50	14.85	18.06	27.8

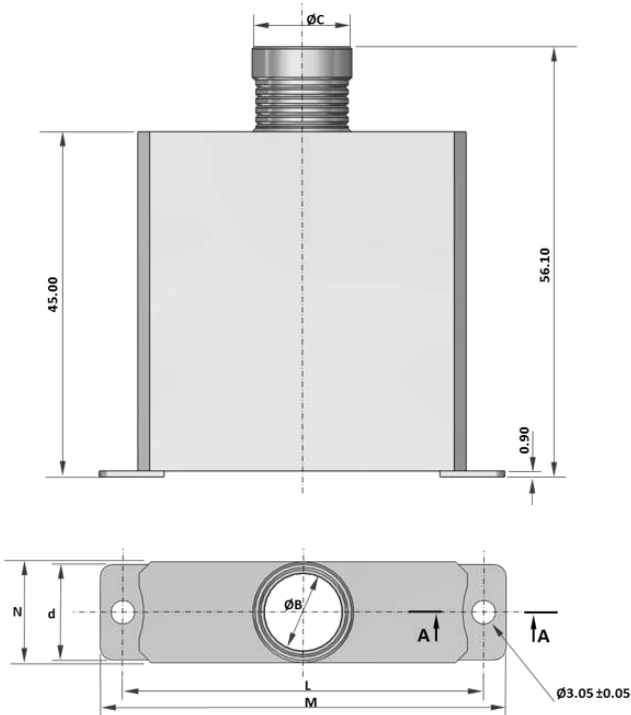

Detail A-A Sizes E, A, B, C and D

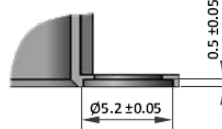

Detail A-A Size F

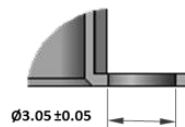

DESCRIPTION & PART NUMBERS

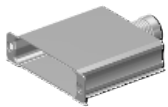
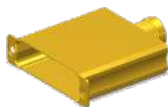
SHELL FINISH	SHELL SIZE	ESA/ESCC DESCRIPTION	C&K PART NUMBER
 Electroless Nickel	E	340107294B NMB-A174	C115366-2938D
	A	340107295B NMB-A174	C115366-2939D
	B	340107296B NMB-A174	C115366-2940D
	C	340107297B NMB-A174	C115366-2941D
	D	340107298B NMB-A174	C115366-2942D
	F	340107299B NMB-A174	C115366-2943D
 Gold	E	340107294B NMB	C115366-2038C
	A	340107295B NMB	C115366-2939C
	B	340107296B NMB	C115366-2940C
	C	340107297B NMB	C115366-2941C
	D	340107298B NMB	C115366-2942C
	F	340107299B NMB	C115366-2943C



Dimensions shown in: mm
 Specifications and dimensions subject to change

D-Sub Lightweight Backshell
Haloring Compatible
Top Elliptical Outlet

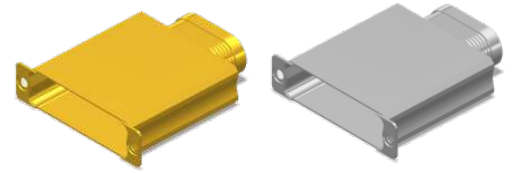

DIMENSIONS & WEIGHT

		Value						Weight (grams)
		M ±0.38	N ±0.2	d ±0.2	L ±0.13	B ±0.15	E ±0.15	
Shell Size	E	30.56	13.26	12.55	24.99	16.60	19.81	12.4
	A	38.89	13.26	12.55	33.32	24.10	27.31	15.5
	B	52.78	13.26	12.55	47.04	24.10	27.31	20
	C	69.04	13.26	12.55	63.50	24.10	27.31	25.6
	D	66.67	15.36	15.35	61.11	34.10	37.31	27
	F	69.32	18.06	17.35	63.50	37.60	40.81	28.8

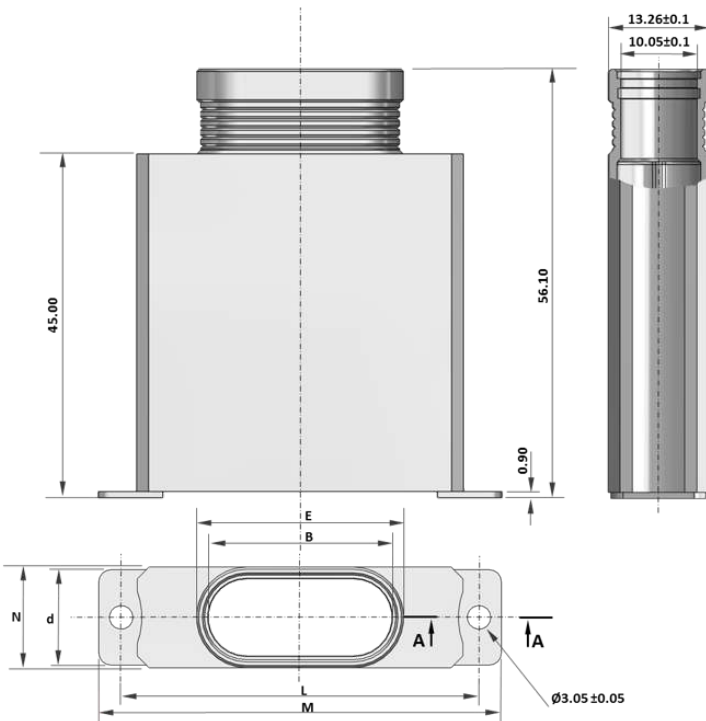

Detail A-A Sizes E, A B, C and D

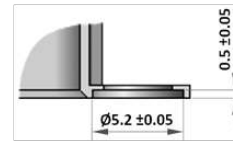

Detail A-A Size F

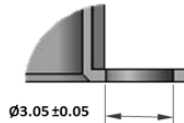

DESCRIPTION & PART NUMBERS

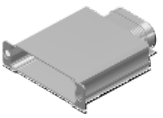
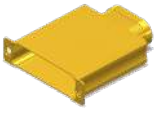
SHELL FINISH	SHELL SIZE	ESA/ESCC DESCRIPTION	C&K PART NUMBER
 Electroless Nickel	E	3401072100B NMB-A174	C115366-2944D
	A	3401072101B NMB-A174	C115366-2945D
	B	3401072102B NMB-A174	C115366-2946D
	C	3401072103B NMB-A174	C115366-2947D
	D	3401072104B NMB-A174	C115366-2948D
	F	3401072105B NMB-A174	C115366-2949D
 Gold	E	3401072100B NMB	C115366-2044C
	A	3401072101B NMB	C115366-2945C
	B	3401072102B NMB	C115366-2946C
	C	3401072103B NMB	C115366-2947C
	D	3401072104B NMB	C115366-2948C
	F	3401072105B NMB	C115366-2949C

Dimensions shown in: mm
 Specifications and dimensions subject to change

D-Sub Lightweight Backshell
Haloring Compatible
45° Circular Outlet

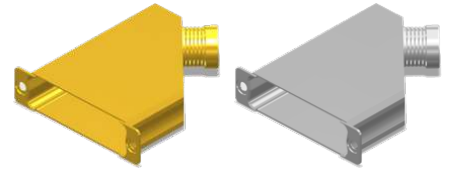

DIMENSIONS & WEIGHT

		Value							Weight (grams)
		M ±0.38	N ±0.2	d ±0.2	L ±0.13	ØB ±0.1	ØC ±0.1	F ±0.2	
Shell Size	E	30.56	13.26	12.55	24.99	10.05	13.26	40	13.3
	A	38.89	13.26	12.55	33.32	10.05	13.26	35	15.9
	B	52.78	13.26	12.55	47.04	10.05	13.26	25	19.2
	C	69.04	13.26	12.55	63.50	10.05	13.26	20	24.7
	D	66.67	15.36	15.35	61.11	12.85	15.36	20	25.7
	F	69.32	18.06	17.35	63.50	14.85	18.06	20	27.7

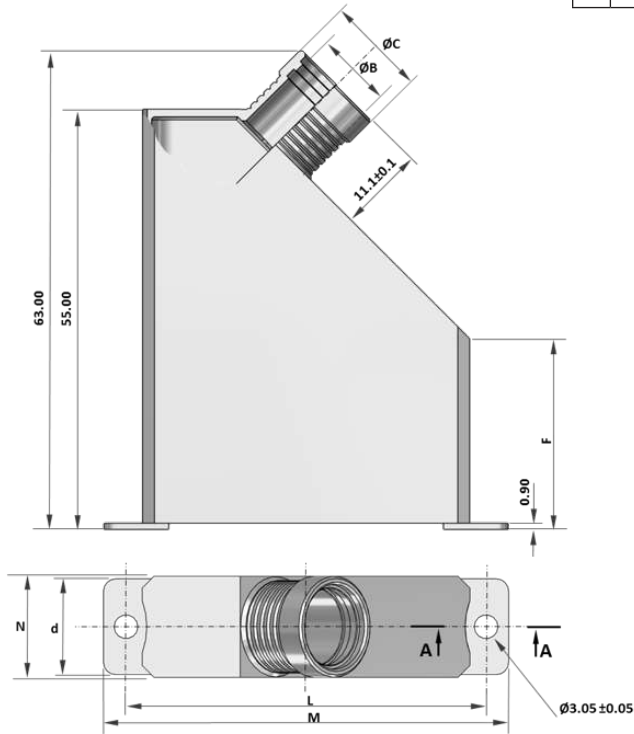

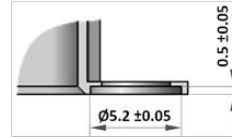

Detail A-A Sizes E, A B, C and D

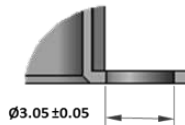

Detail A-A Size F

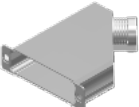

DESCRIPTION & PART NUMBERS

SHELL FINISH	SHELL SIZE	ESA/ESCC DESCRIPTION	C&K PART NUMBER
 Electroless Nickel	E	3401072106B NMB-A174	C115366-2950D
	A	3401072107B NMB-A174	C115366-2951D
	B	3401072108B NMB-A174	C115366-2952D
	C	3401072109B NMB-A174	C115366-2953D
	D	3401072110B NMB-A174	C115366-2954D
	F	3401072111B NMB-A174	C115366-2955D
 Gold	E	3401072106B NMB	C115366-2050C
	A	3401072107B NMB	C115366-2951C
	B	3401072108B NMB	C115366-2952C
	C	3401072109B NMB	C115366-2953C
	D	3401072110B NMB	C115366-2954C
	F	3401072111B NMB	C115366-2955C



Dimensions shown in: mm
 Specifications and dimensions subject to change

D-Sub Lightweight Backshell
Haloring Compatible
45° Elliptical Outlet

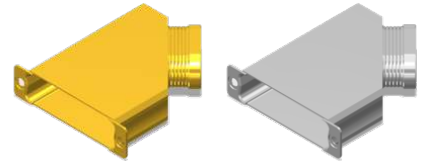

DIMENSIONS & WEIGHT

		Value							Weight (grams)
		M ±0.38	N ±0.2	d ±0.2	L ±0.13	B ±0.15	E ±0.15	F ±0.2	
Shell Size	E	30.56	13.26	12.55	24.99	16.60	19.81	40	13.6
	A	38.89	13.26	12.55	33.32	24.10	27.31	35	16.6
	B	52.78	13.26	12.55	47.04	24.10	27.31	25	19.9
	C	69.04	13.26	12.55	63.50	24.10	27.31	20	25.4
	D	66.67	15.36	15.35	61.11	34.10	37.31	20	26.7
	F	69.32	18.06	17.35	63.50	37.60	40.81	20	28.7

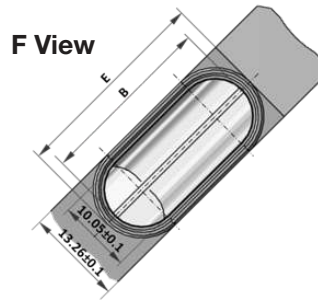
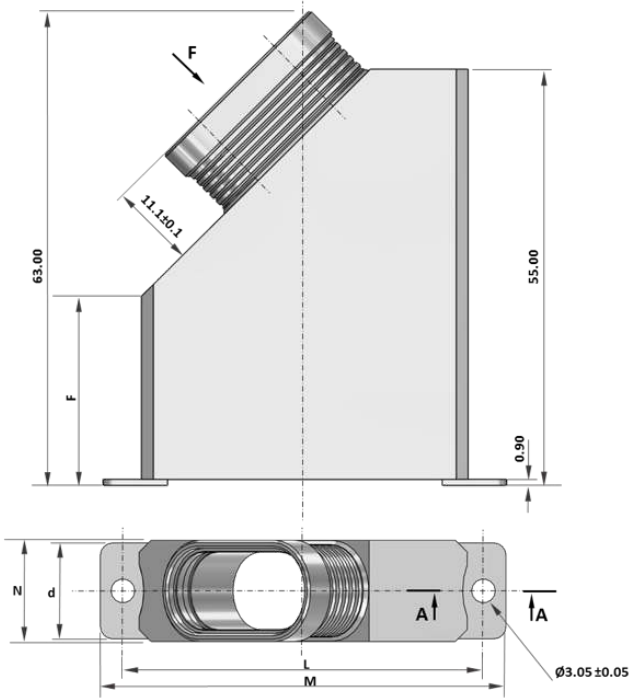

Detail A-A Sizes E, A B, C and D

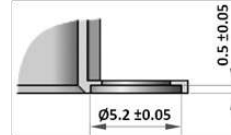

Detail A-A Size F

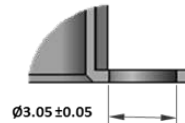

DESCRIPTION & PART NUMBERS

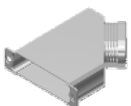
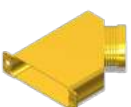
SHELL FINISH	SHELL SIZE	ESA/ESCC DESCRIPTION	C&K PART NUMBER
 Electroless Nickel	E	3401072112B NMB-A174	C115366-2956D
	A	3401072113B NMB-A174	C115366-2957D
	B	3401072114B NMB-A174	C115366-2958D
	C	3401072115B NMB-A174	C115366-2959D
	D	3401072116B NMB-A174	C115366-2960D
	F	3401072117B NMB-A174	C115366-2961D
 Gold	E	3401072112B NMB	C115366-2056C
	A	3401072113B NMB	C115366-2957C
	B	3401072114B NMB	C115366-2958C
	C	3401072115B NMB	C115366-2959C
	D	3401072116B NMB	C115366-2960C
	F	3401072117B NMB	C115366-2961C

Dimensions shown in: mm
 Specifications and dimensions subject to change

D-Sub Lightweight Backshell
Haloring Compatible
90° Cylindrical Outlet

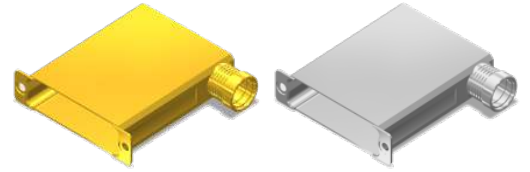

DIMENSIONS & WEIGHT

		Value						Weight (grams)
		M ±0.38	N ±0.2	d ±0.2	L ±0.13	ØB ±0.1	ØC ±0.1	
Shell Size	E	30.56	13.26	12.55	24.99	10.05	13.26	14.7
	A	38.89	13.26	12.55	33.32	10.05	13.26	18.1
	B	52.78	13.26	12.55	47.04	10.05	13.26	23.6
	C	69.04	13.26	12.55	63.50	10.05	13.26	30.5
	D	66.67	15.36	15.35	61.11	12.85	15.36	31.7
	F	69.32	18.06	17.35	63.50	14.85	18.06	33.8

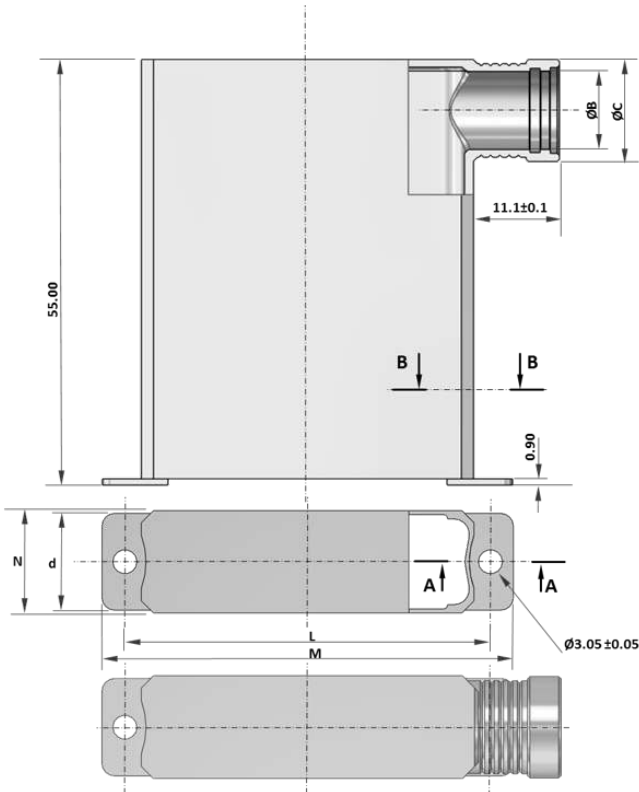

Detail A-A Sizes E, A B, C and D

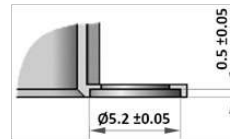

Detail A-A Size F

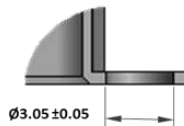

DESCRIPTION & PART NUMBERS

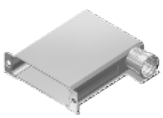
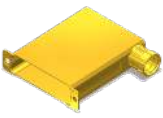
SHELL FINISH	SHELL SIZE	ESA/ESCC DESCRIPTION	C&K PART NUMBER
 Electroless Nickel	E	3401072118B NMB-A174	C115366-2962D
	A	3401072119B NMB-A174	C115366-2963D
	B	3401072120B NMB-A174	C115366-2964D
	C	3401072121B NMB-A174	C115366-2965D
	D	3401072122B NMB-A174	C115366-2966D
	F	3401072123B NMB-A174	C115366-2967D
 Gold	E	3401072118B NMB	C115366-2062C
	A	3401072119B NMB	C115366-2963C
	B	3401072120B NMB	C115366-2964C
	C	3401072121B NMB	C115366-2965C
	D	3401072122B NMB	C115366-2966C
	F	3401072123B NMB	C115366-2967C



Dimensions shown in: mm
 Specifications and dimensions subject to change

D-Sub Lightweight Backshell
Haloring Compatible
90° Elliptical Outlet

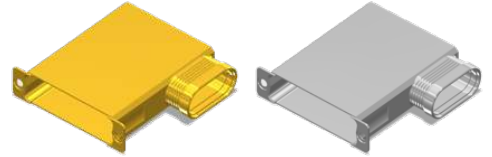

DIMENSIONS & WEIGHT

		Value						Weight (grams)
		M ±0.38	N ±0.2	d ±0.2	L ±0.13	B ±0.15	E ±0.15	
Shell Size	E	30.56	13.26	12.55	24.99	16.60	19.81	13.6
	A	38.89	13.26	12.55	33.32	24.10	27.31	16.6
	B	52.78	13.26	12.55	47.04	24.10	27.31	19.9
	C	69.04	13.26	12.55	63.50	24.10	27.31	25.4
	D	66.67	15.36	15.35	61.11	34.10	37.31	26.7
	F	69.32	18.06	17.35	63.50	37.60	40.81	28.7

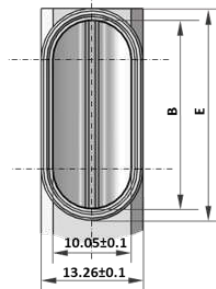
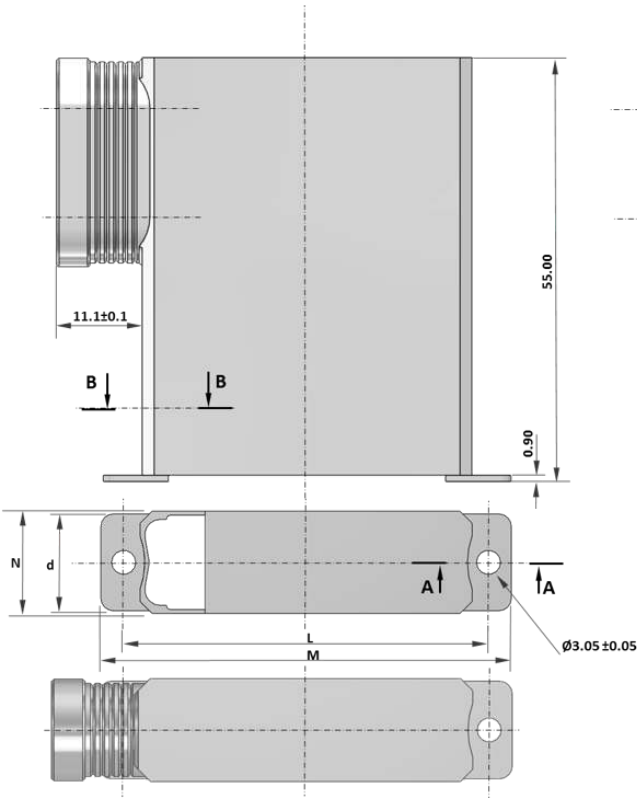

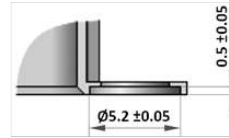

Detail A-A Sizes E, A B, C and D

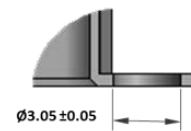

Detail A-A Size F

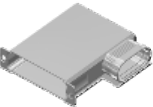

DESCRIPTION & PART NUMBERS

SHELL FINISH	SHELL SIZE	ESA/ESCC DESCRIPTION	C&K PART NUMBER
 Electroless Nickel	E	3401072124B NMB-A174	C115366-2968D
	A	3401072125B NMB-A174	C115366-2969D
	B	3401072126B NMB-A174	C115366-2970D
	C	3401072127B NMB-A174	C115366-2971D
	D	3401072128B NMB-A174	C115366-2972D
	F	3401072129B NMB-A174	C115366-2973D
 Gold	E	3401072124B NMB	C115366-2068C
	A	3401072125B NMB	C115366-2969C
	B	3401072126B NMB	C115366-2970C
	C	3401072127B NMB	C115366-2971C
	D	3401072128B NMB	C115366-2972C
	F	3401072129B NMB	C115366-2973C

Dimensions shown in: mm
 Specifications and dimensions subject to change

D-Sub Lightweight Backshell
Haloring Compatible
90° Top Circular Outlet

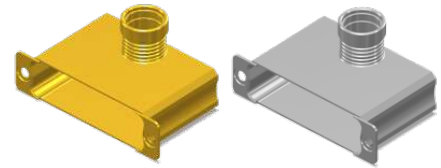

DIMENSIONS & WEIGHT

		Value						Weight (grams)
		M ±0.38	N ±0.2	d ±0.2	L ±0.13	ØB ±0.1	ØC ±0.1	
Shell Size	E	30.56	13.26	12.55	24.99	10.05	13.26	8.2
	A	38.89	13.26	12.55	33.32	10.05	13.26	10
	B	52.78	13.26	12.55	47.04	10.05	13.26	12.9
	C	69.04	13.26	12.55	63.50	10.05	13.26	16.6
	D	66.67	15.36	15.35	61.11	12.85	15.36	17.6
	F	69.32	18.06	17.35	63.50	14.85	18.06	18.9

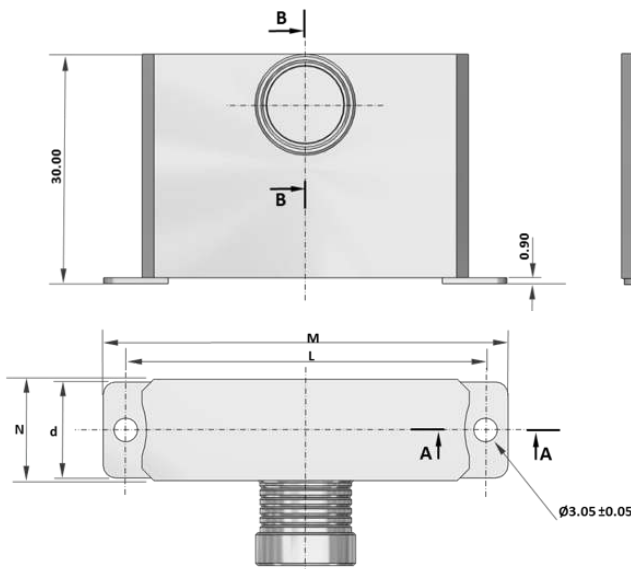

Detail A-A Sizes E, A B, C and D

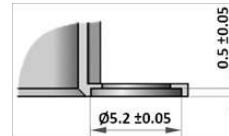

Detail A-A Size F

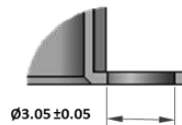

DESCRIPTION & PART NUMBERS

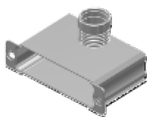
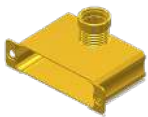
SHELL FINISH	SHELL SIZE	ESA/ESCC DESCRIPTION	C&K PART NUMBER
 Electroless Nickel	E	3401072130B NMB-A174	C115366-2974D
	A	3401072131B NMB-A174	C115366-2975D
	B	3401072132B NMB-A174	C115366-2976D
	C	3401072133B NMB-A174	C115366-2977D
	D	3401072134B NMB-A174	C115366-2978D
	F	3401072135B NMB-A174	C115366-2979D
 Gold	E	3401072130B NMB	C115366-2074C
	A	3401072131B NMB	C115366-2975C
	B	3401072132B NMB	C115366-2976C
	C	3401072133B NMB	C115366-2977C
	D	3401072134B NMB	C115366-2978C
	F	3401072135B NMB	C115366-2979C



Dimensions shown in: mm
 Specifications and dimensions subject to change

D-Sub Lightweight Backshell
Haloring Compatible
90° Top Elliptical Outlet

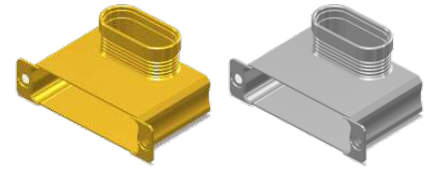

DIMENSIONS & WEIGHT

		Value						Weight (grams)
		M ±0.38	N ±0.2	d ±0.2	L ±0.13	B ±0.15	E ±0.15	
Shell Size	E	30.56	13.26	12.55	24.99	11.85	15.06	8.3
	A	38.89	13.26	12.55	33.32	16.60	19.81	10.3
	B	52.78	13.26	12.55	47.04	24.10	27.31	13.6
	C	69.04	13.26	12.55	63.50	24.10	27.31	17.3
	D	66.67	15.36	15.35	61.11	34.10	37.31	18.6
	F	69.32	18.06	17.35	63.50	34.10	37.31	20

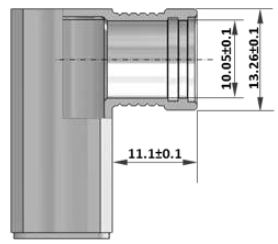
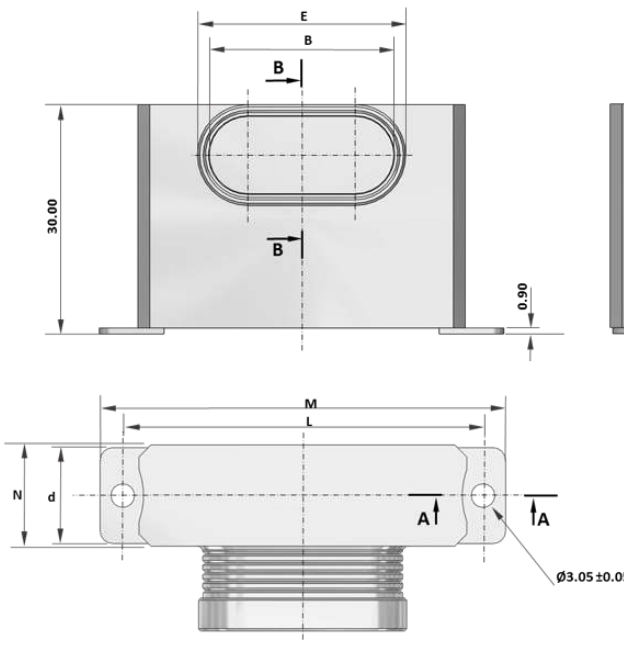

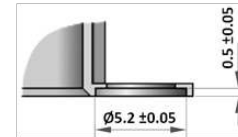

Detail A-A Sizes E, A, B, C and D

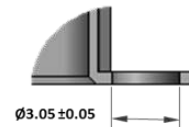

Detail A-A Size F

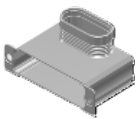

DESCRIPTION & PART NUMBERS

SHELL FINISH	SHELL SIZE	ESA/ESCC DESCRIPTION	C&K PART NUMBER
 Electroless Nickel	E	3401072136B NMB-A174	C115366-2980D
	A	3401072137B NMB-A174	C115366-2981D
	B	3401072138B NMB-A174	C115366-2982D
	C	3401072139B NMB-A174	C115366-2983D
	D	3401072140B NMB-A174	C115366-2984D
	F	3401072141B NMB-A174	C115366-2985D
 Gold	E	3401072136B NMB	C115366-2080C
	A	3401072137B NMB	C115366-2981C
	B	3401072138B NMB	C115366-2982C
	C	3401072139B NMB	C115366-2983C
	D	3401072140B NMB	C115366-2984C
	F	3401072141B NMB	C115366-2985C

Dimensions shown in: mm
 Specifications and dimensions subject to change



D-Sub Lightweight Backshell
Haloring Compatible
45° Top Circular Outlet

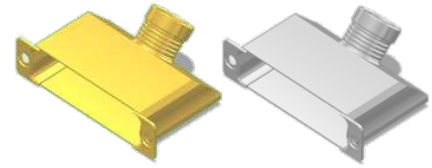

DIMENSIONS & WEIGHT

		Value						Weight (grams)
		M ±0.38	N ±0.2	d ±0.2	L ±0.13	ØB ±0.1	ØC ±0.1	
Shell Size	E	30.56	13.26	12.55	24.99	10.05	13.26	8
	A	38.89	13.26	12.55	33.32	10.05	13.26	9.9
	B	52.78	13.26	12.55	47.04	10.05	13.26	12.9
	C	69.04	13.26	12.55	63.50	10.05	13.26	16.8
	D	66.67	15.36	15.35	61.11	12.85	15.36	16.2
	F	69.32	18.06	17.35	63.50	14.85	18.06	17.6

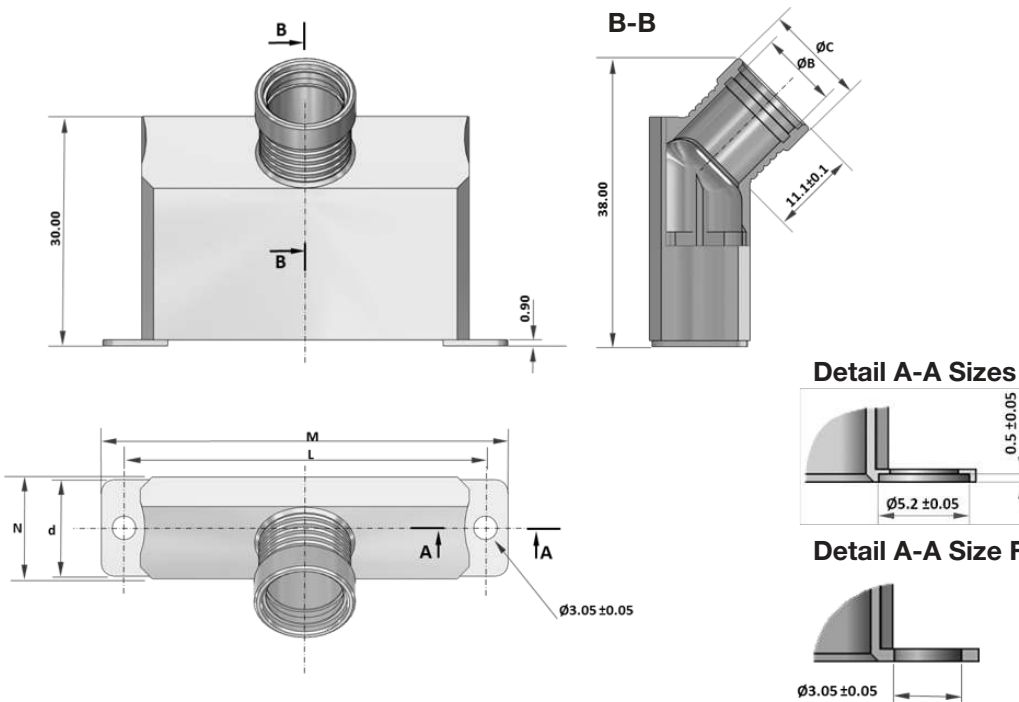

DESCRIPTION & PART NUMBERS

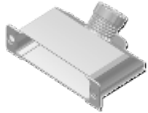
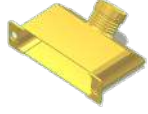
SHELL FINISH	SHELL SIZE	ESA/ESCC DESCRIPTION	C&K PART NUMBER
 Electroless Nickel	E	3401072142B NMB-A174	C115366-2986D
	A	3401072143B NMB-A174	C115366-2987D
	B	3401072144B NMB-A174	C115366-2988D
	C	3401072145B NMB-A174	C115366-2989D
	D	3401072146B NMB-A174	C115366-2990D
	F	3401072147B NMB-A174	C115366-2991D
 Gold	E	3401072142B NMB	C115366-2086C
	A	3401072143B NMB	C115366-2987C
	B	3401072144B NMB	C115366-2988C
	C	3401072145B NMB	C115366-2989C
	D	3401072146B NMB	C115366-2990C
	F	3401072147B NMB	C115366-2991C



Dimensions shown in: mm
 Specifications and dimensions subject to change

D-Sub Lightweight Backshell
Haloring Compatible
45° Top Elliptical Outlet

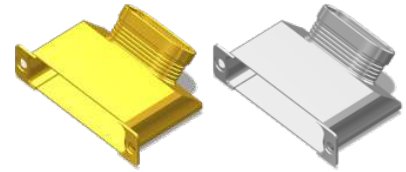

DIMENSIONS & WEIGHT

		Value						Weight (grams)
		M ±0.38	N ±0.2	d ±0.2	L ±0.13	B ±0.15	E ±0.15	
Shell Size	E	30.56	13.26	12.55	24.99	11.85	15.06	8.1
	A	38.89	13.26	12.55	33.32	16.60	19.81	10.2
	B	52.78	13.26	12.55	47.04	24.10	27.31	13.6
	C	69.04	13.26	12.55	63.50	24.10	27.31	17.4
	D	66.67	15.36	15.35	61.11	34.10	37.31	17.8
	F	69.32	18.06	17.35	63.50	34.10	37.31	18.7

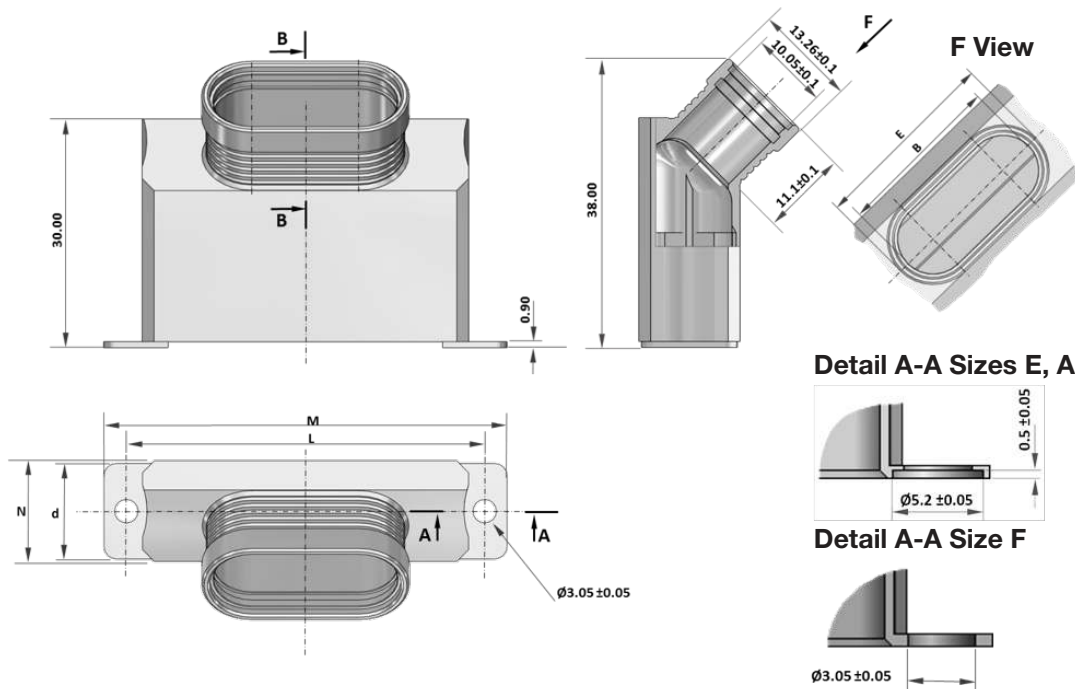

Detail A-A Sizes E, A B, C and D

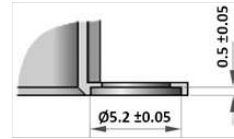

Detail A-A Size F

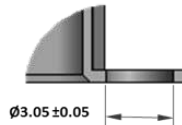

DESCRIPTION & PART NUMBERS

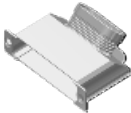
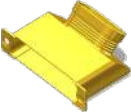
SHELL FINISH	SHELL SIZE	ESA/ESCC DESCRIPTION	C&K PART NUMBER
 Electroless Nickel	E	3401072148B NMB-A174	C115366-2992D
	A	3401072149B NMB-A174	C115366-2993D
	B	3401072150B NMB-A174	C115366-2994D
	C	3401072151B NMB-A174	C115366-2995D
	D	3401072152B NMB-A174	C115366-2996D
	F	3401072153B NMB-A174	C115366-2997D
 Gold	E	3401072148B NMB	C115366-2092C
	A	3401072149B NMB	C115366-2993C
	B	3401072150B NMB	C115366-2994C
	C	3401072151B NMB	C115366-2995C
	D	3401072152B NMB	C115366-2996C
	F	3401072153B NMB	C115366-2997C

Dimensions shown in: mm
 Specifications and dimensions subject to change

D-Sub Haloring Compatible 45° Top Elliptical Outlet

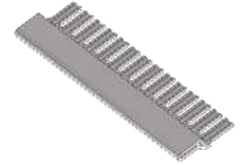

DIMENSIONS & WEIGHT



		A ±0.2	B ±0.3	Number of Tines	Weight (grams)
Shell Size	E	15.00	12.00	6	1.3
	A	22.50	12.00	9	1.9
	B	35.00	12.00	14	2.9
	C & D	47.50	12.00	19	4
	F	52.50	15.00	21	5.2

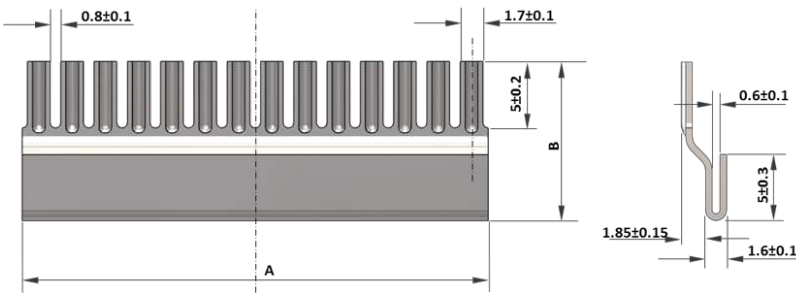

The internal shape of the backshell and the profile of the haloring have been specifically studied in order to overcome the space constraints and ensure ease of use during wiring of the shielded wires

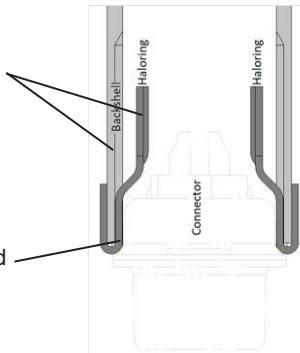

Haloring is held between the connector and the backshell

Note: All our Backshells haloring compatible are designed to be used with 1 or 2 halorings on the 2 large sides.

DESCRIPTION & PART NUMBERS

	SHELL SIZE	ESA/ESCC DESCRIPTION	C&K PART NUMBER
	E	340107283B NMB	C115366-2927C
	A	340107284B NMB	C115366-2928C
	B	340107285B NMB	C115366-2929C
	C & D	340107286B NMB	C115366-2930C
	F	340107287B NMB	C115366-2931C



*Dimensions shown in: mm
Specifications and dimensions subject to change*

ACCESSORIES

Universal Male Screwlock - Slotted Head	ESA/ESCC DESCRIPTION	C&K PART NUMBER
	340102287B NMB	C115366-2408C
Universal Male Screwlock - Hexagonal Hole Head	ESA/ESCC DESCRIPTION	C&K PART NUMBER
	340102289B NMB	C115366-2410C
Specific Female Screwlock for use with Backshell	ESA/ESCC DESCRIPTION	C&K PART NUMBER
	340102297B NMB	C115366-2416C

HDS ESCC D-Sub Lightweight Backshell - June 2020

Dimensions shown in: mm
Specifications and dimensions subject to change