

Product Summary @ $T_A = +25^{\circ}\text{C}$

V_{RRM} (V)	I_o (A)	V_F (V)	I_R (μA)
600 to 1000	10	1.1	10

Description and Applications

10.0A Surface Mount Glass Passivated Rectifier in SMC package, offers high current capability and low forward voltage drop.

Features and Benefits

- Glass Passivated Die Construction
- Low Forward Voltage Drop and High Current Capability
- Surge Overload Rating to 250A Peak
- Ideally Suited for Automated Assembly
- **Lead-Free Finish; RoHS Compliant (Notes 1 & 2)**
- **Halogen- and Antimony-Free. "Green" Device (Note 3)**
- **For automotive applications requiring specific change control (i.e. parts qualified to AEC-Q100/101/200, PPAP capable, and manufactured in IATF 16949 certified facilities), please [contact us](mailto:contact@diodes.com) or your local Diodes representative. <https://www.diodes.com/quality/product-definitions/>**

Mechanical Data

- Case: SMC
- Case Material: Molded Plastic.
UL Flammability Classification Rating 94V-0
- Moisture Sensitivity: Level 1 per J-STD-020
- Terminals: Lead Free Plating (Matte Tin Finish). Solderable per MIL-STD-202, Method 208
- Polarity: Cathode Band or Cathode Notch
- Weight: 0.21 grams (Approximate)

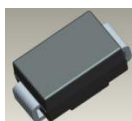

Top View

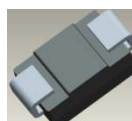

Bottom View

Ordering Information (Note 4)

Part Number	Qualification	Case	Packaging
S10xC-13	Commercial	SMC	3,000/Tape & Reel

*x = Device type, e.g. S10MC-13.

- Notes:
1. EU Directive 2002/95/EC (RoHS), 2011/65/EU (RoHS 2) & 2015/863/EU (RoHS 3) compliant. All applicable RoHS exemptions applied.
 2. See <https://www.diodes.com/quality/lead-free/> for more information about Diodes Incorporated's definitions of Halogen- and Antimony-free, "Green" and Lead-free.
 3. Halogen- and Antimony-free "Green" products are defined as those which contain <900ppm bromine, <900ppm chlorine (<1500ppm total Br + Cl) and <1000ppm antimony compounds.
 4. For packaging details, go to our website at <https://www.diodes.com/design/support/packaging/diodes-packaging/>.

Marking Information

xxxx = Product Type Marking Code (ex: S10M for S10MC; S10K for S10KC; S10J for S10JC)
 YWW = Manufacturers' Code Marking
 YWW = Date Code Marking
 Y = Last Digit of Year (ex: 0 for 2020)
 WW = Week Code (01 to 52)

Maximum Ratings (@ T_A = +25°C, unless otherwise specified.)

Single phase, half wave, 60Hz, resistive or inductive load.
For capacitive load, derate current by 20%.

Characteristic	Symbol	S10JC	S10KC	S10MC	Unit
Peak Repetitive Reverse Voltage	V _{RRM}				
Working Peak Reverse Voltage	V _{RWM}	600	800	1,000	V
DC Blocking Voltage	V _R				
RMS Reverse Voltage	V _{R(RMS)}	426	560	700	V
Average Rectified Output Current	I _O		10.0		A
Non-Repetitive Peak Forward Surge Current, 8.3ms	@ T _T = +75°C				
Single Half Sine-Wave Superimposed on Rated Load	@ T _J = +25°C		250		A
	@ T _J = +125°C		200		A
Non-Repetitive Peak Forward Surge Current, 1.0ms	@ T _J = +25°C			500	A
Single Half Sine-Wave Superimposed on Rated Load	@ T _J = +125°C			400	A
I ² t Rating for Fusing (t < 8.3ms)	I ² t		518.75		A ² S

Thermal Characteristics

Characteristic	Symbol	Value	Unit
Typical Thermal Resistance, Junction to Case (Note 6)	R _{θJC}	3	°C/W
Typical Thermal Resistance, Junction to Terminal (Note 6)	R _{θJT}	7	°C/W
Typical Thermal Resistance, Junction to Ambient (Note 6)	R _{θJA}	12	°C/W
Typical Thermal Resistance, Junction to Case (Note 7)	R _{θJC}	8	°C/W
Typical Thermal Resistance, Junction to Terminal (Note 7)	R _{θJT}	13	°C/W
Typical Thermal Resistance, Junction to Ambient (Note 7)	R _{θJA}	41	°C/W
Operating and Storage Temperature Range	T _J , T _{STG}	-65 to +150	°C

Electrical Characteristics (@ T_A = +25°C, unless otherwise specified.)

Characteristic	Symbol	Value	Unit	
Minimum Reverse Breakdown Voltage	@ I _R = 1μA	V _{(BR)R}	S10MC: 1,000 S10KC: 800 S10JC: 600	V
Maximum Forward Voltage	@ I _F = 10.0A	V _{FM}	1.1	V
Peak Reverse Current	@ T _A = +25°C	I _{RM}	10	μA
	@ T _A = +125°C		250	
Typical Total Capacitance (Note 5)	C _T		45	pF

- Notes:
5. Measured at 1.0MHz and applied reverse voltage of 4.0V DC.
 6. Thermal resistance measured with device mounted on aluminum pad with 100mm x 100mm x 2mm heatsink.
 7. Thermal resistance measured without heat sink attached.

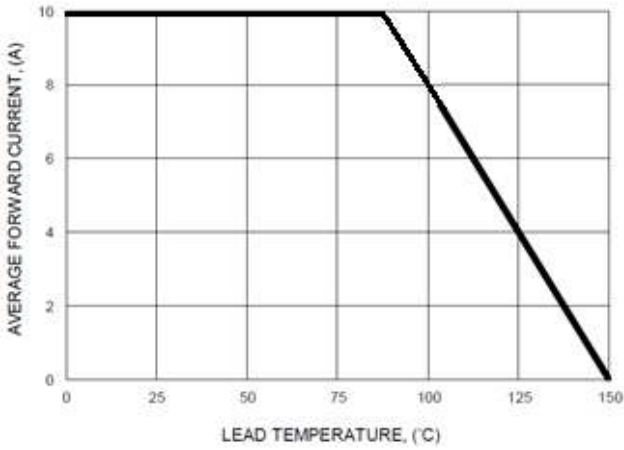

FIG.1- FORWARD CURRENT DERATING CURVE

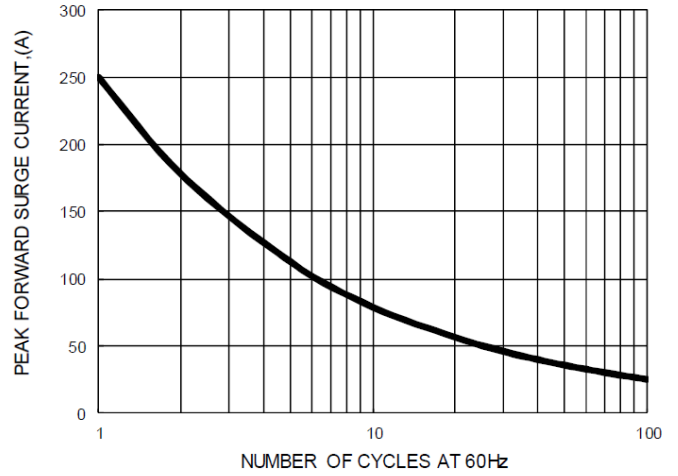

FIG.2- MAXIMUM NON-REPETITIVE SURGE CURRENT

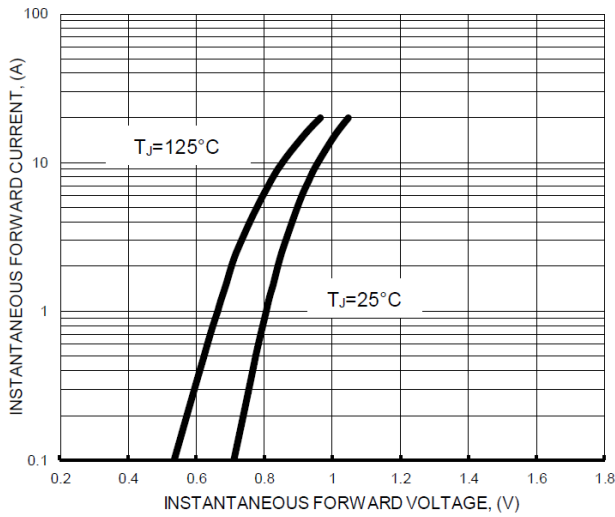

FIG.3- TYPICAL FORWARD CHARACTERISTICS

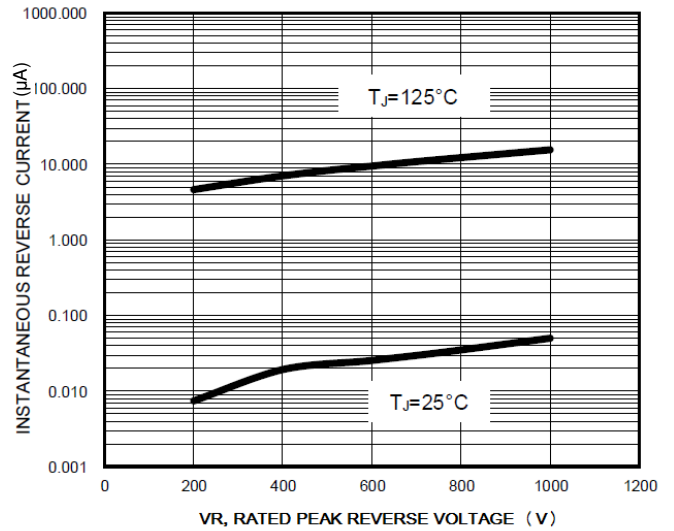
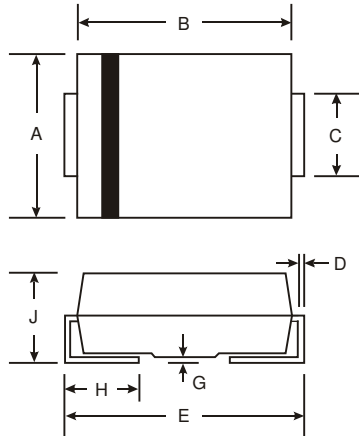

FIG.4- TYPICAL REVERSE CHARACTERISTICS

Package Outline Dimensions

Please see <http://www.diodes.com/package-outlines.html> for the latest version.

SMC



SMC		
Dim	Min	Max
A	5.59	6.22
B	6.60	7.11
C	2.75	3.18
D	0.15	0.31
E	7.75	8.13
G	0.10	0.20
H	0.76	1.52
J	2.00	2.50
All Dimensions in mm		

Suggested Pad Layout

Please see <http://www.diodes.com/package-outlines.html> for the latest version.

SMC

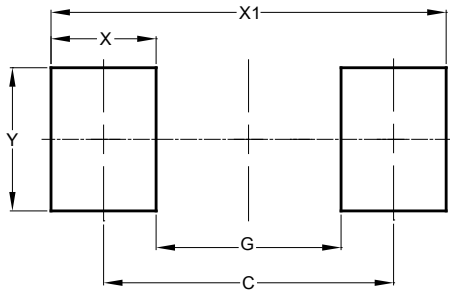

Dimensions	Value (in mm)
C	6.90
G	4.40
X	2.50
X1	9.40
Y	3.30

IMPORTANT NOTICE

DIODES INCORPORATED MAKES NO WARRANTY OF ANY KIND, EXPRESS OR IMPLIED, WITH REGARDS TO THIS DOCUMENT, INCLUDING, BUT NOT LIMITED TO, THE IMPLIED WARRANTIES OF MERCHANTABILITY AND FITNESS FOR A PARTICULAR PURPOSE (AND THEIR EQUIVALENTS UNDER THE LAWS OF ANY JURISDICTION).

Diodes Incorporated and its subsidiaries reserve the right to make modifications, enhancements, improvements, corrections or other changes without further notice to this document and any product described herein. Diodes Incorporated does not assume any liability arising out of the application or use of this document or any product described herein; neither does Diodes Incorporated convey any license under its patent or trademark rights, nor the rights of others. Any Customer or user of this document or products described herein in such applications shall assume all risks of such use and will agree to hold Diodes Incorporated and all the companies whose products are represented on Diodes Incorporated website, harmless against all damages.

Diodes Incorporated does not warrant or accept any liability whatsoever in respect of any products purchased through unauthorized sales channel. Should Customers purchase or use Diodes Incorporated products for any unintended or unauthorized application, Customers shall indemnify and hold Diodes Incorporated and its representatives harmless against all claims, damages, expenses, and attorney fees arising out of, directly or indirectly, any claim of personal injury or death associated with such unintended or unauthorized application.

Products described herein may be covered by one or more United States, international or foreign patents pending. Product names and markings noted herein may also be covered by one or more United States, international or foreign trademarks.

This document is written in English but may be translated into multiple languages for reference. Only the English version of this document is the final and determinative format released by Diodes Incorporated.

LIFE SUPPORT

Diodes Incorporated products are specifically not authorized for use as critical components in life support devices or systems without the express written approval of the Chief Executive Officer of Diodes Incorporated. As used herein:

A. Life support devices or systems are devices or systems which:

1. are intended to implant into the body, or
2. support or sustain life and whose failure to perform when properly used in accordance with instructions for use provided in the labeling can be reasonably expected to result in significant injury to the user.

B. A critical component is any component in a life support device or system whose failure to perform can be reasonably expected to cause the failure of the life support device or to affect its safety or effectiveness.

Customers represent that they have all necessary expertise in the safety and regulatory ramifications of their life support devices or systems, and acknowledge and agree that they are solely responsible for all legal, regulatory and safety-related requirements concerning their products and any use of Diodes Incorporated products in such safety-critical, life support devices or systems, notwithstanding any devices- or systems-related information or support that may be provided by Diodes Incorporated. Further, Customers must fully indemnify Diodes Incorporated and its representatives against any damages arising out of the use of Diodes Incorporated products in such safety-critical, life support devices or systems.

Copyright © 2020, Diodes Incorporated

www.diodes.com