

IS31AP4991A 1.1W AUDIO POWER AMPLIFIER WITH ACTIVE-LOW SHUTDOWN MODE

DESCRIPTION

The IS31AP4991A has been designed for demanding audio applications such as mobile phones and permits the reduction of the number of external components. It is capable of delivering 1.1W of continuous RMS output power into an 8Ω load @ 5V.

An externally-controlled standby mode reduces the supply current to much less than 1μA. It also includes internal thermal shutdown protection. The unity-gain stable amplifier can be configured by external gain setting resistors.

FEATURES

- Operating from $V_{CC} = 2.7V \sim 5.5V$
- 1.1W output power @ $V_{CC} = 5V$, THD+N= 1%, $f = 1kHz$, with 8Ω load
- Ultra-low consumption in standby mode (much less than 1μA)
- 56dB PSRR @217Hz in grounded mode
- Near-zero click-and-pop
- Ultra-low distortion (0.074%@0.5W, 1kHz)
- SOP-8 and MSOP-8 package

QUICK START



Figure 1: Photo of IS31AP4991A Evaluation Board (MSOP-8)

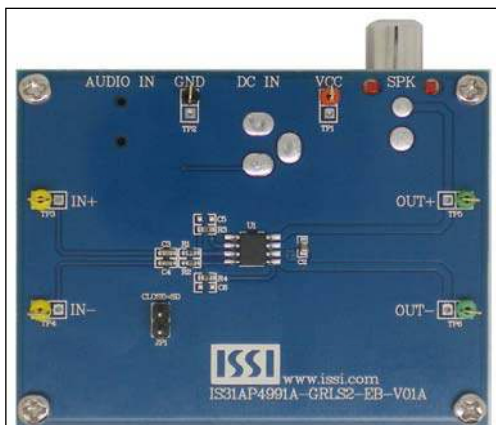

Figure 2: Photo of IS31AP4991A Evaluation Board (SOP-8)

RECOMMENDED EQUIPMENT

- 5.0V, 1A power supply
- Audio source (i.e. MP3 player, Notebook PC, etc.)
- 8Ω speakers

ABSOLUTE MAXIMUM RATINGS

- $\leq 5.5V$ power supply

Caution: Do not exceed the conditions listed above, otherwise the board will be damaged.

PROCEDURE

The IS31AP4991A evaluation board is fully assembled and tested. Follow the steps listed below to verify board operation.

Caution: Do not turn on the power supply until all connections are completed.

- 1) Connect an 8Ω (or larger) speaker across the OUT- terminal and OUT+ terminal. Or connect speaker to the connector (SPK).
- 2) Connect the ground terminal of the power supply to the GND and the positive terminal to the VCC. Or connect DC power to the connector (DC IN).
- 3) If the audio source is differential, connect the negative of the audio source to the IN- terminal, and connect the positive of the audio source to IN+ terminal.
- 4) If the audio source is single-ended, C3 and R1 should disconnect, and R3 should be 0Ω. Connect the audio source to the IN- terminal, or connect audio source to the connector (AUDIO IN).
- 5) Turn on the power supply.
- 6) Turn on the audio source.

IS31AP4991A 1.1W AUDIO POWER AMPLIFIER WITH ACTIVE-LOW SHUTDOWN MODE

ORDERING INFORMATION

Part No.	Temperature Range	Package
IS31AP4991A-GRLS2-EB IS31AP4991A-SLS2-EB	-40°C ~ +85°C (Industrial)	SOP-8, Lead-free MSOP-8, Lead-free

Table 1: Ordering Information

For pricing, delivery, and ordering information, please contact Lumissil's analog marketing team at analog@lumissil.com or (408) 969-6600.

EVALUATION BOARD OPERATION

The IS31AP4991A demo board features the IS31AP4991A Class-AB power amplifier IC, designed to drive speaker impedance of 8Ω or larger.

CUSTOMIZING THE GAIN

The IS31AP4991A demo board is shipped with a gain of 6dB and is set by resistors R_I (R_1 , R_2) and R_F (R_3 , R_4). Change resistors R_I and R_F to reconfigure the gain of the board and gain determined in Equation (1):

$$Gain = \frac{2 \times R_F}{R_I} \left(\frac{V}{V} \right) \quad (1)$$

HIGH-PASS FILTER

The input capacitor C_1 (C_3 , C_4) and input resistor R_I (R_1 , R_2) form a high-pass filter with the corner frequency, f_c , determined in Equation (2) and refer to IS31AP4991A datasheet for more detail.

$$f_c = \frac{1}{(2\pi R_I C_I)} \quad (2)$$

SHUTDOWN MODE

Jumper (JP1) controls the shutdown pin of the IS31AP4991A IC. Connect the jumper (JP1) to enter the shutdown mode of the board.

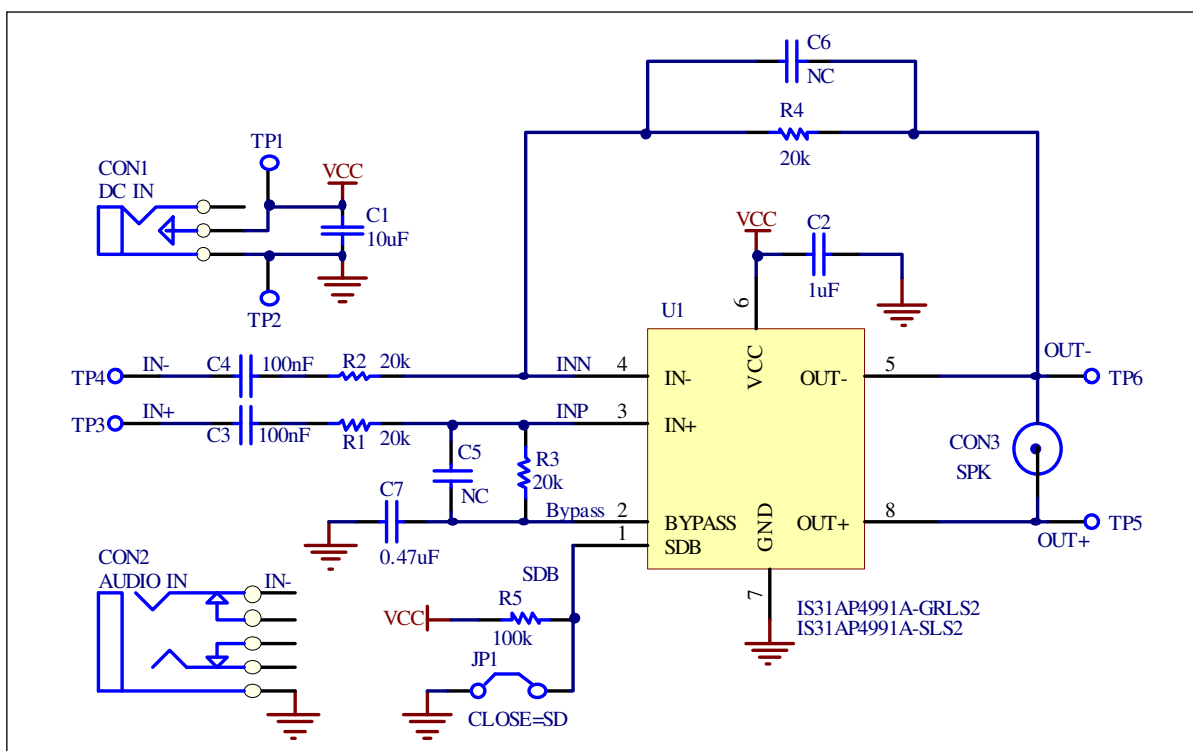

Figure 3: IS31AP4991A Application Schematic

IS31AP4991A 1.1W AUDIO POWER AMPLIFIER WITH ACTIVE-LOW SHUTDOWN MODE



BILL OF MATERIALS

Name	Symbol	Description	Qty	Supplier	Part No.
Amplifier	U1	Class- AB Power Amplifier	1	Lumissil	IS31AP4991A-SLS2 IS31AP4991A-GRLS2
Resistor	R1,R2,R3,R4	RES,20k, 1/16W,±1%,SMD	4	Yageo	RC0603FR-0720KL
Resistor	R5	RES,100k, 1/16W,±5%,SMD	1	Yageo	RC0603JR-07100KL
Capacitor	C1	CAP,10µF,16V,±20%,SMD	1	Yageo	CC0805KKX7R6BB106
Capacitor	C2,C8	CAP, 1µF, 50V,±10%,SMD	2	Yageo	CC0603KKX7R9BB105
Capacitor	C3,C4	CAP,0.1µF,50V,±10%,SMD	2	Yageo	CC0603KKX7R9BB104
Capacitor	C7	CAP,0.47µF,50V,±10%,SMD	1	Yageo	CC0603KKX7R9BB474
Connector	DC IN	2.5 mm DC connector	1		
Connector	SPK	RCA –type Connector	1		
connector	AUDIO IN	3.5mm min connector	1		
	C5,C6	Not Installed			

Bill of materials, refer to Figure 2 above.

IS31AP4991A 1.1W AUDIO POWER AMPLIFIER WITH ACTIVE-LOW SHUTDOWN MODE

MSOP-8 Package

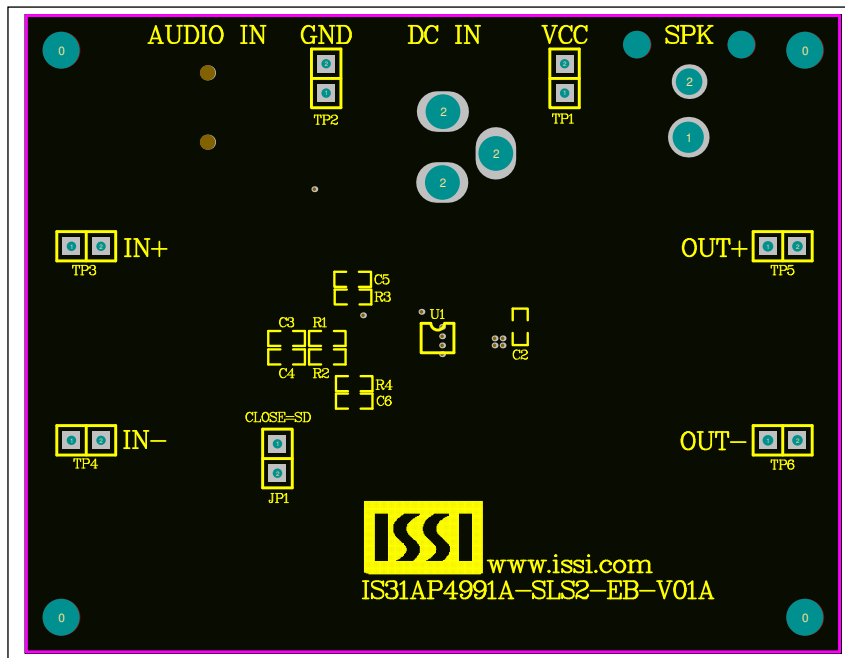

Figure 4: Board Component Placement Guide - Top Layer

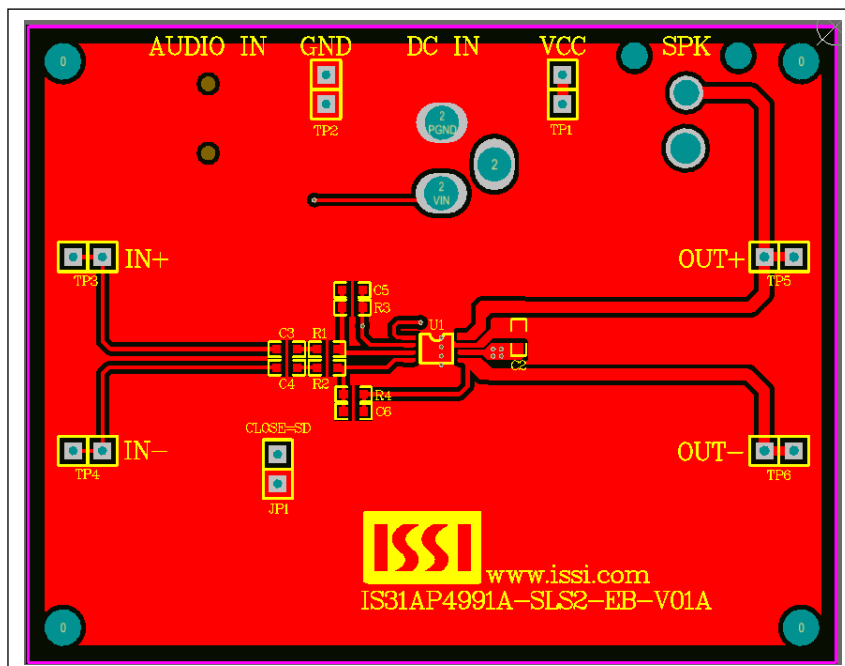

Figure 5: Board PCB Layout - Top Layer

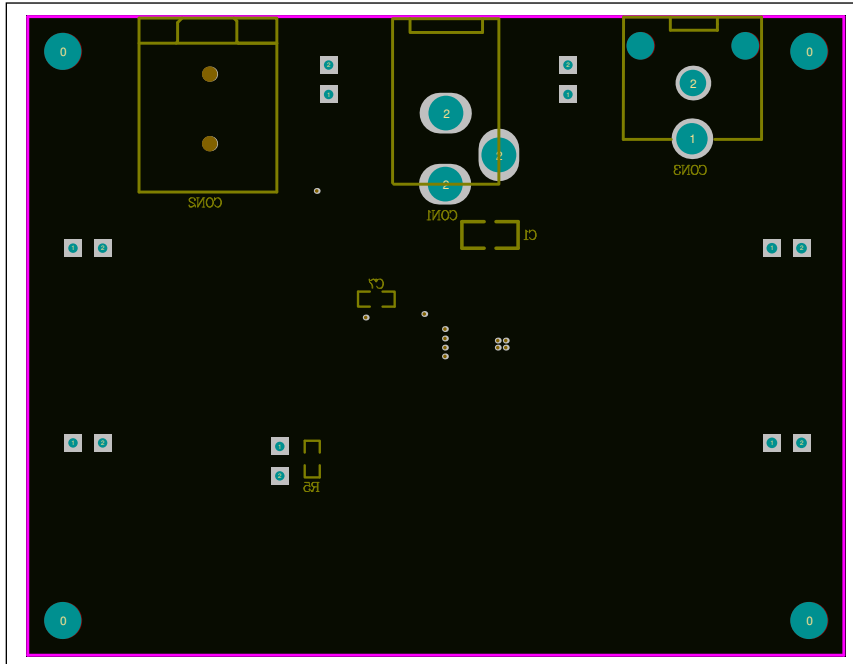

Figure 6: Board Component Placement Guide - Bottom Layer

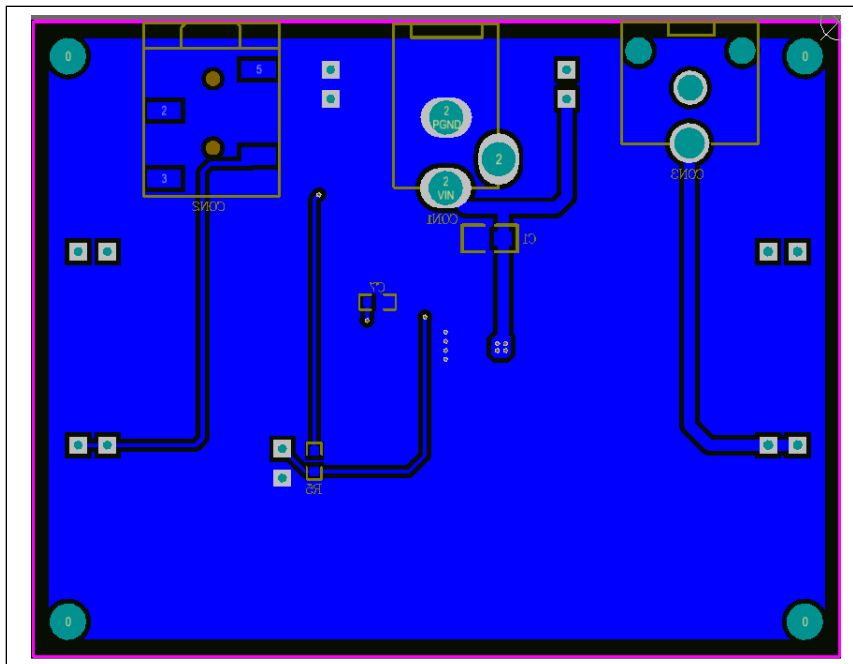

Figure 7: Board PCB Layout - Bottom Layer

IS31AP4991A 1.1W AUDIO POWER AMPLIFIER WITH ACTIVE-LOW SHUTDOWN MODE

SOP-8 Package

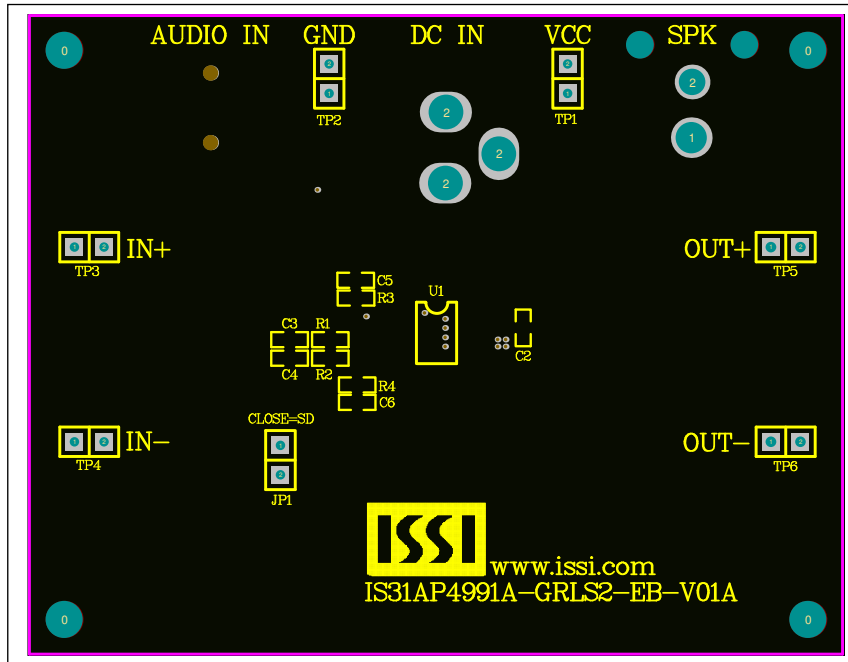

Figure 8: Board Component Placement Guide - Top Layer

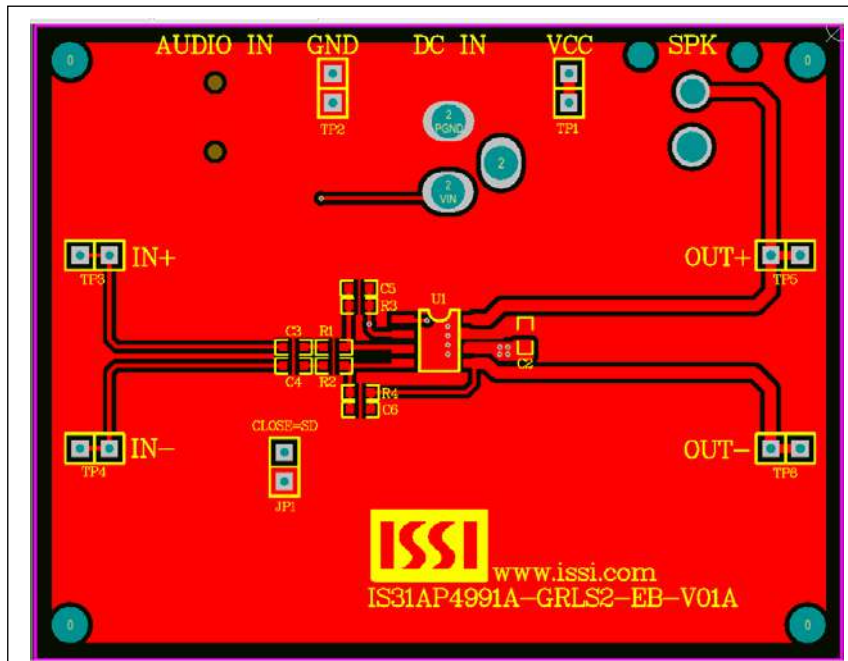

Figure 9: Board PCB Layout - Top Layer

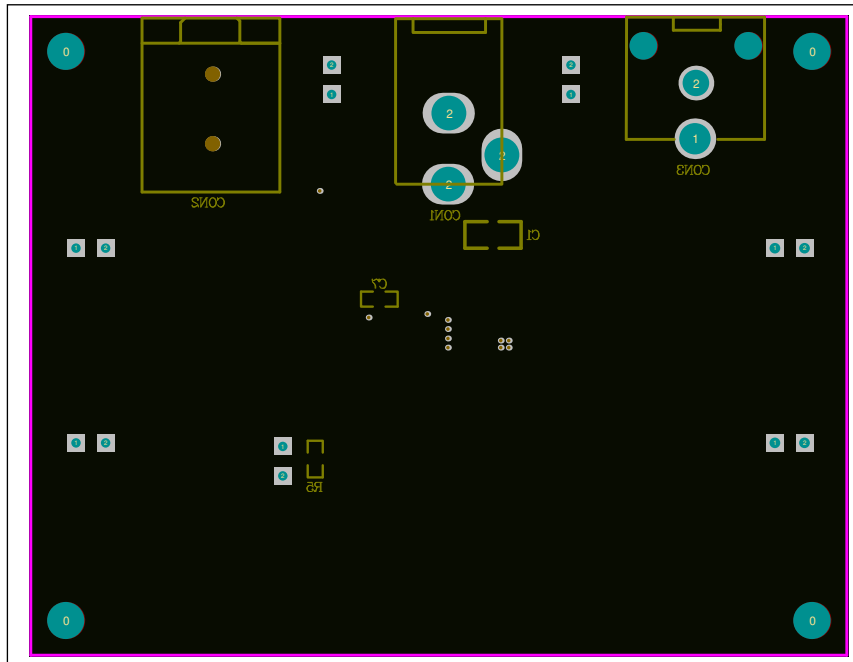

Figure 10: Board Component Placement Guide - Bottom Layer

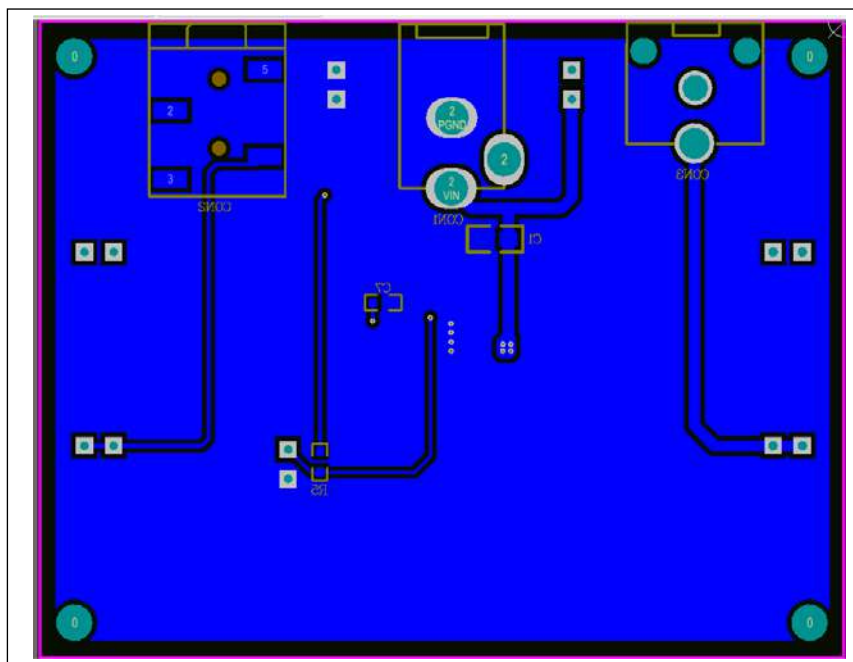

Figure 11: Board PCB Layout - Bottom Layer

Copyright © 2015 Lumissil Microsystems. All rights reserved. Lumissil Microsystems reserves the right to make changes to this specification and its products at any time without notice. Lumissil Microsystems assumes no liability arising out of the application or use of any information, products or services described herein. Customers are advised to obtain the latest version of this device specification before relying on any published information and before placing orders for products.

Lumissil Microsystems does not recommend the use of any of its products in life support applications where the failure or malfunction of the product can reasonably be expected to cause failure of the life support system or to significantly affect its safety or effectiveness. Products are not authorized for use in such applications unless Lumissil Microsystems receives written assurance to its satisfaction, that:

- a.) the risk of injury or damage has been minimized;
- b.) the user assume all such risks; and
- c.) potential liability of Lumissil Microsystems is adequately protected under the circumstances