



SPECIFICATION SHEET

SPECIFICATION SHEET NO.	N0929- SMCS3JC000S360
DATE	Sept. 29, 2021
REVISION	A0
DESCRIPTION	<p>SMD General Purpose Rectifier, SMC/DO-214AB series, S3JC Type, 2 Pads</p> <p>Reverse Voltage 600V Max. Forward Current 3.0A Max.</p> <p>Operating Temp. Range -55°C ~+150°C</p> <p>Package in Tape/Reel, 3000pcs/Reel</p> <p>RoHS/RoHS III compliant</p>
CUSTOMER	
CUSTOMER PART NUMBER	
CROSS REF. PART NUMBER	
ORIGINAL PART NUMBER	MDD S3JC
PART CODE	SMCS3JC000S360

VENDOR APPROVE			
Issued/Checked/Approved			
DATE: Sept. 29, 2021			

CUSTOMER APPROVE	
DATE:	

SMD GENERAL PURPOSE RECTIFIER SMC SERIES



MAIN FEATURE

- The plastic package carries Underwriters Laboratory Flammability Classification 94V-0
- Low reverse leakage
- Open Junction chip
- High forward surge current capability
- High temperature soldering guaranteed: 250°C/ 10 seconds at terminals
- Built-in strain relief, ideal for automated placement

APPLICATION

- For printed circuit board

RFQ

[Request For Quotation](#)

PART CODE GUIDE

SMC	S3JC000	S	360
1	2	3	4

1) **SMC**: SMD General Purpose Rectifier, SMC/DO-214AB series,

2) **S3JC000**: Type Code for original part number S3JC

3) **S**: Package code, Tape/reel, 3000pcs/reel.

4) **360**: Specification code for Forward Current 3.0A Max. Reverse Voltage 600V Max.

MORE ITEMS AVAILABLE

SMCS3AC000S305	SMCS3BC000S310	SMCS3DC000S320	SMCS3GC000S340	SMCS3JC000S360
SMCS3KC000S380	SMCS3MC000S30A			
SMCS5AC000S505	SMCS5BC000S510	SMCS5DC000S520	SMCS5GC000S540	SMCS5JC000S560
SMCS5KC000S580	SMCS5MC000S50A			
SMCS6AC000S605	SMCS6BC000S610	SMCS6DC000S620	SMCS6GC000S640	SMCS6JC000S660
SMCS6KC000S680	SMCS6MC000S60A			
SMCS10AC00SA05	SMCS10BC00SA10	SMCS10DC00SA20	SMCS10GC00SA40	SMCS10JC00SA60
SMCS10KC00SA80	SMCS10MC00SA0A			

SMD GENERAL PURPOSE RECTIFIER SMC SERIES

DIMENSION (Unit: Inch/mm)

Image for reference



Marking: S3JC

SMC/DO-214AB

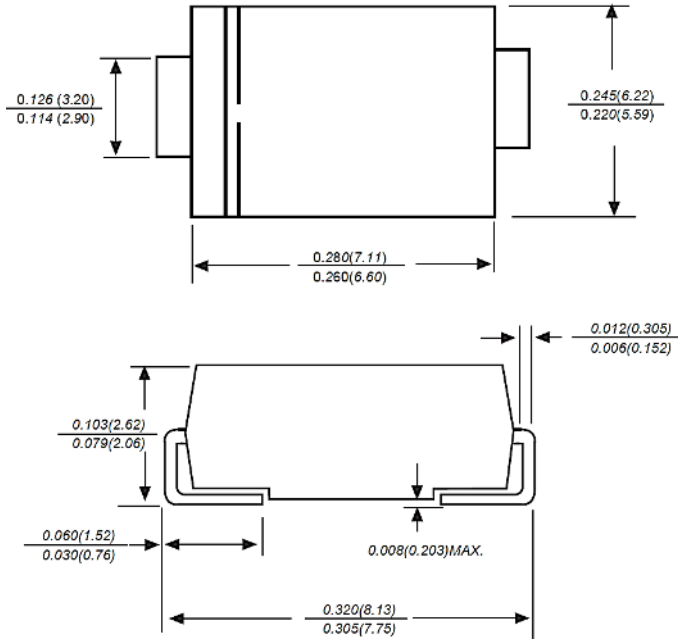

Recommend Pad Layout

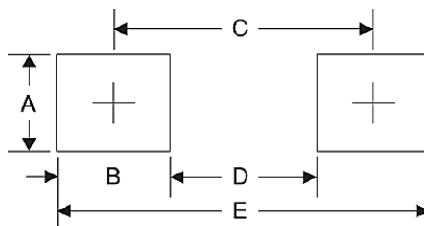

Symbol	Unit (inch)	Unit (mm)
A	0.170	4.30
B	0.160	4.10
C	0.311	7.90
D	0.150	3.80
E	0.472	12.0

SMD GENERAL PURPOSE RECTIFIER SMC SERIES
MECHANICAL DATA

Case	Terminals	Polarity	Mounting Position	Weight per piece
JEDEC SMC/DO-214AB molded plastic body	Solder plated, Solderable per MIL-STD-750, Method 2026	Polarity symbol marking on case	Any	0.0070 Ounce, 0.2180 grams

MAX. RATING & CHARACTERISTICS

Parameter	SYMBOLS	VALUE			UNITS
		Min.	Typical	Max.	
Repetitive peak reverse voltage	V _{RRM}			600	Volts
RMS voltage	V _{RMS}			420	Volts
DC blocking voltage	V _{DC}			600	Volts
Average forward output rectified current	I _{AV}			3.0	A
Peak forward surge current 8.3ms single half sine-wave superimposed on rated load (JEDEC Method)	I _{FSM}			90	A
Instantaneous forward voltage at 3.0A	V _F			1.0	Volts
DC reverse current at rated DC blocking voltage	I _R			5.0	μA
				100	μA
Junction capacitance (Note 3)	C _J		40		pF
Thermal resistance (Note 4)	R _{QJA}		40		°C/W
	R _{QJC}		16		
Operating junction temperature range	T _J	-55		+150	°C
Storage temperature range	T _{STG}	-55		+150	°C

Note

- Ratings at 25 C ambient temperature unless otherwise specified. Single phase half-wave 60Hz, resistive or inductive load, for capacitive load current derate by 20%.
- Reverse recovery condition IF=0.5A,IR=1.0A,Irr=0.25A
- Measured at 1.0MHz and applied reverse voltage of 4.0Voltage
- P.C.B. mounted with 0.2x0.2"(5.0x5.0mm) copper pad areas.

SMD GENERAL PURPOSE RECTIFER SMC SERIES
RELIABILITY

Number	Experiment Items	Experiment Method And Conditions	Reference Documents
1	Solder Resistance Test	Test 260°C± 5°C for 10 ± 2 sec. Immerse body into solder 1/16" ± 1/32"	MIL-STD-750D METHOD-2031.2
2	Solderability Test	230°C ±5°C for 5 sec.	MIL-STD-750D METHOD-2026.1 0
3	Pull Test	1 kg in axial lead direction for 10 sec.	MIL-STD-750D METHOD-2036.4
4	Bend Test	0.5Kg Weight Applied To Each Lead, Bending Arcs 90 °C ± 5 °C For 3 Times	MIL-STD-750D METHOD-2036.4
5	High Temperature Reverse Bias Test	TA=100°C for 1000 Hours at VR=80% Rated VR	MIL-STD-750D METHOD-1038.4
6	Forward Operation Life Test	TA=25°C Rated Average Rectified Current	MIL-STD-750D METHOD-1027.3
7	Intermittent Operation Life Test	On state: 5 min with rated IRMS Power Off state: 5 min with Cool Forced Air. On and off for 1000 cycles.	MIL-STD-750D METHOD-1036.3
8	Pressure Cooker Test	15 PSIG, TA=121°C, 4 hours	MIL-S-19500 APPENOIXC
9	Temperature Cycling Test	-55°C~+125°C; 30 Minutes For Dwelled Time 5 minutes for transferred time. Total: 10 cycles.	MIL-STD-750D METHOD-1051.7
10	Thermal Shock Test	0°C for 5 minutes., 100°C for 5minutes, Total: 10 cycles	MIL-STD-750D METHOD-1056.7
11	Forward Surge Test	8.3ms Single Sale Sine-wave One Surge.	MIL-STD-750D METHOD-4066.4
12	Humidity Test	TA=65°C, RH=98% for 1000 hours.	MIL-STD-750D METHOD-1021.3
13	High Temperature Storage life Test	150°C for 1000 Hours	MIL-STD-750D METHOD-1031.5

SMD GENERAL PURPOSE RECTIFIER SMC SERIES

SUGGESTED REFLOW PROFILE (For Reference Only)

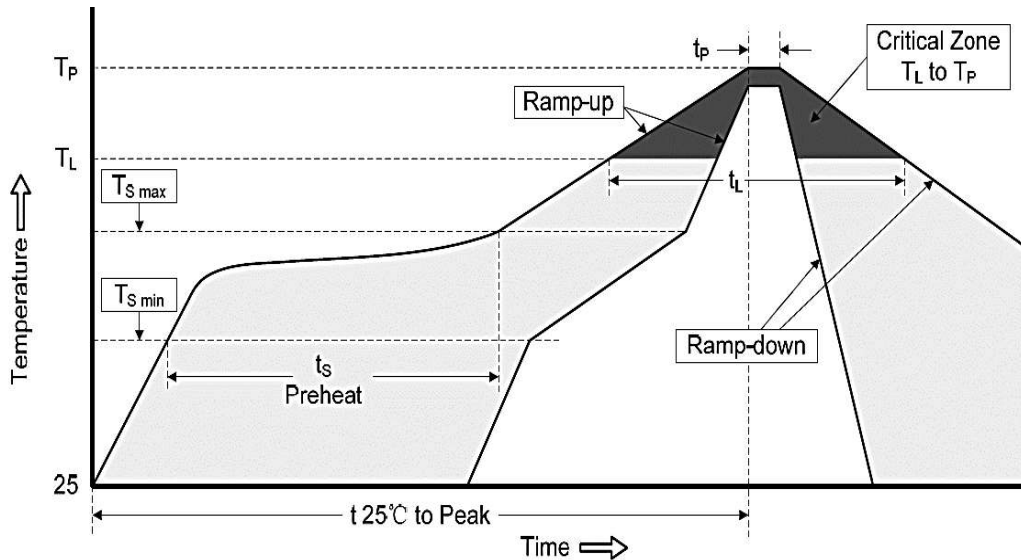

Profile Feature		Pb-Free Assembly
Average Ramp-up Rate (Ts Max to Tp)		3°C/second Max
Preheat	Temperature Min (Ts Min.)	150°C
	Temperature Max (Ts Max.)	200°C
	Time (ts Min. to ts Max.)	60 ~ 180 seconds
Time maintained above	Temperature (Tl)	217°C
	Time (tl)	60 ~ 150 seconds
Peak/Classification Temperature (Tp)		260 °C
Time within 5°C of actual Peak Temperature (tp)		20 ~ 40 seconds
Ramp-down rate		6 °C /Second Max.
Time 25 °C to Peak Temperature		8 minutes Max.
Suggest reflow times		3 Times Max.

SMD GENERAL PURPOSE RECTIFIER SMC SERIES

RATINGS AND CHARACTERISTIC CURVES (For Reference Only)

Fig.1 Forward Current Derating Curve

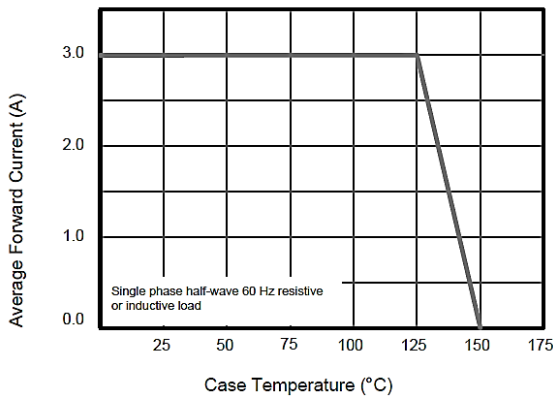

Fig.2 Typical Reverse Characteristics

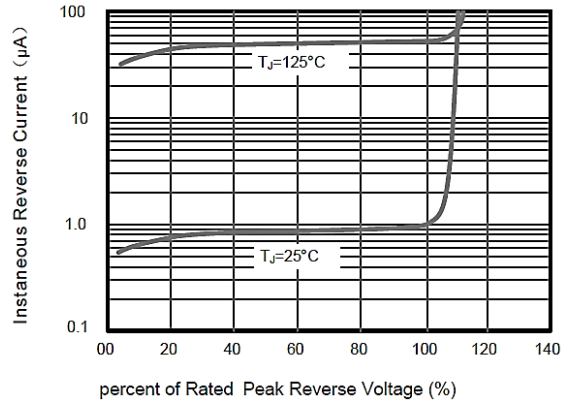

Fig.3 Typical Forward Characteristic

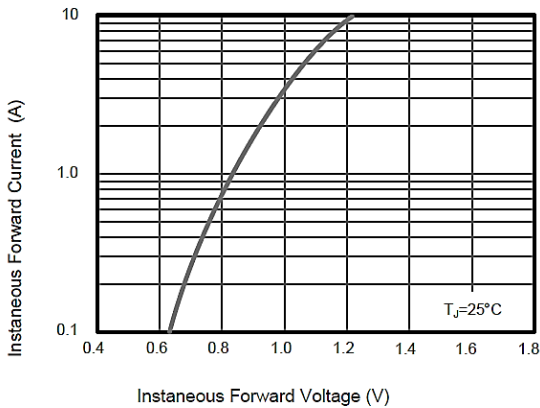

Fig.4 Typical Junction Capacitance

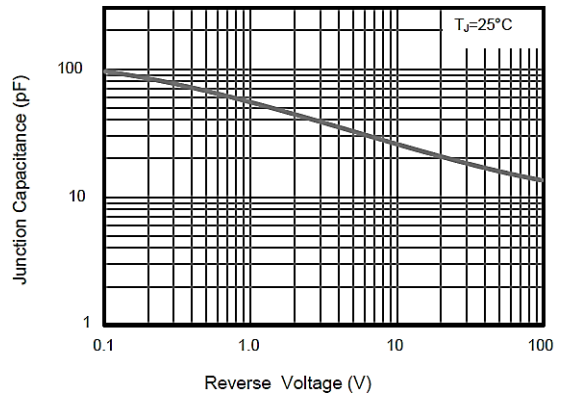
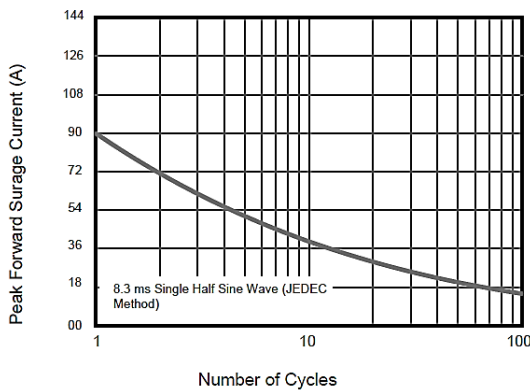

Fig.6 Maximum Non-Repetitive Peak Forward Surge Current



SMD GENERAL PURPOSE RECTIFIER SMC SERIES

TAPE/REEL (Unit: mm)

All Devices are packed in accordance with EIA standard RS-481-A and specifications.

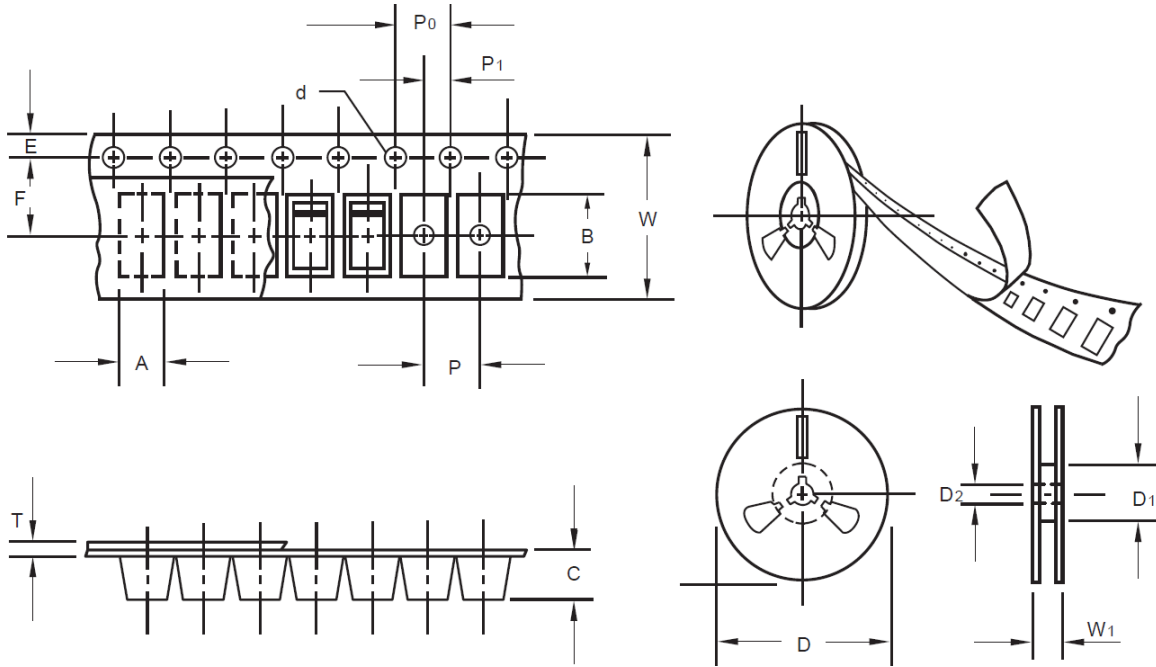

Item	Symbol	Tolerance	SMC/DO-214AB
Carrier width	A	0.1	6.15
Carrier Length	B	0.1	8.41
Carrier Depth	C	0.1	2.42
Sprocket hole	d	0.05	1.50
13" Reel outside diameter	D	2.0	330.00
13" Reel inner diameter	D1	Min.	50.00
7" Reel outside diameter	-	-	-
7" Reel inner diameter	-	-	-
Feed hole diameter	D2	0.5	13.00
Sprocket hole position	E	0.1	1.75
Punch hole position	F	0.1	7.50
Punch hole pitch	P	0.1	8.00
Sprocket hole pitch	P0	0.1	4.00
Embossment center	P1	0.1	2.00
Overall tape thickness	T	0.1	0.25
Tape width	W	0.3	16.00
Reel width	W1	1.0	16.50

SMD GENERAL PURPOSE RECTIFER SMC SERIES

SPQ PACKAGE for Reference

Item	Unit	Value
Case Code		SMC/DO-214AB
Reel Size	Inch	13
Reel Size	mm	330
Tape Space	mm	/
SPQ /Reel	pcs	3000
Weigh /SPQ	LBS	4.63
Weigh /SPQ	KGs	2.10
Qty. Per Box	pcs	6,000
Inner Box	Inch	L13.2*W13.2*H1.95

DISCLAIMER

NextGen Component, Inc. reserves the right to make changes to the product(s) and or information contained herein without notice. No liability is assumed as a result of their use or application. No rights under any patent accompany the sale of any such product(s) or information