

42100-1 ✓ ACTIVE

FASTIN-FASTON | FASTIN-FASTON 250

TE Internal #: 42100-1

Quick Disconnects, Receptacle, 18 – 14 AWG Wire Size, .82 – 2.08 mm² Wire Size, Mating Tab Width 6.35 mm [.25 in], Straight, Brass, FASTIN-FASTON 250

[View on TE.com >](#)



Terminals & Splices > Quick Disconnects

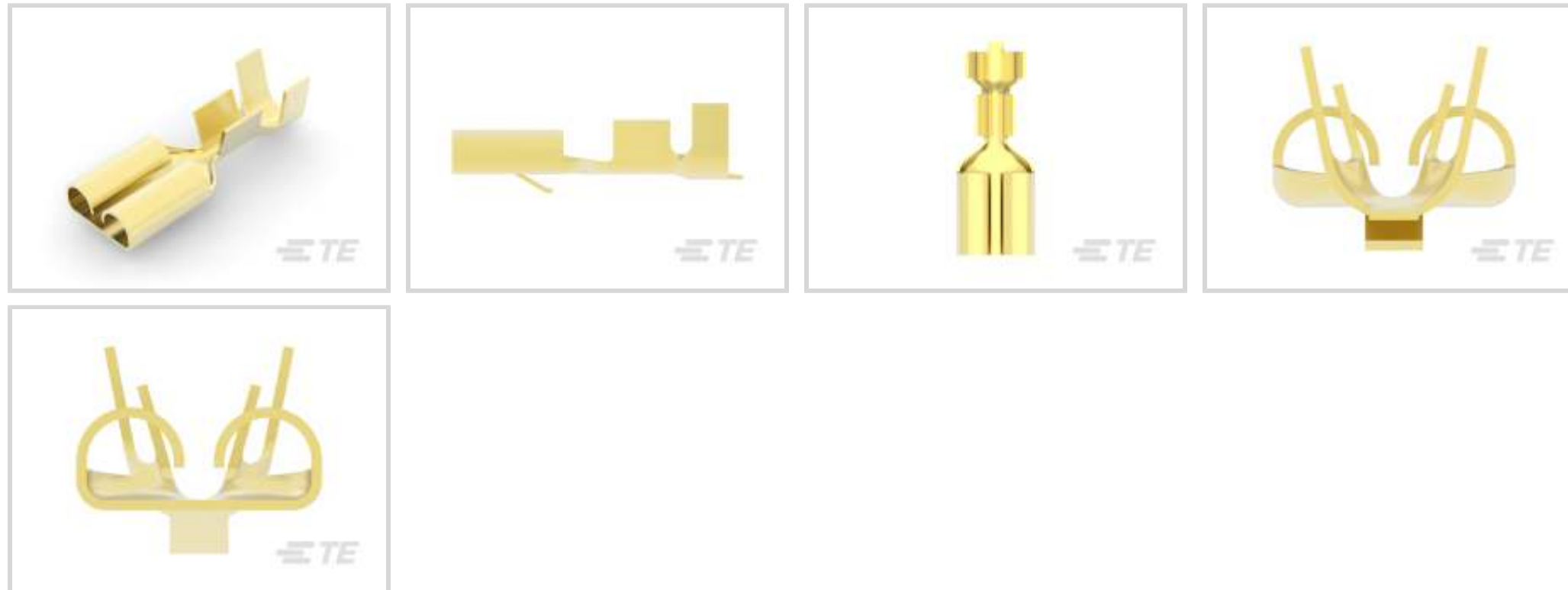

Quick Disconnect Terminal Type: **Receptacle**

Wire Size: **.82 – 2.08 mm²**

Mating Tab Width: **6.35 mm [.25 in]**

Mating Tab Thickness: **.81 mm [.032 in]**

Features

Product Type Features

Insertion Force	Normal
-----------------	--------

Configuration Features

Connection Capacity	Single
---------------------	--------

Compatible With Wire & Cable Type	Discrete Wire
-----------------------------------	---------------

Contact Features

Quick Disconnect Terminal Type	Receptacle
--------------------------------	------------

Mating Tab Width	6.35 mm [.25 in]
------------------	------------------

Mating Tab Thickness	.81 mm [.032 in]
----------------------	------------------

Terminal Orientation	Straight
----------------------	----------

Contact Base Material	Brass
-----------------------	-------

Terminal Plating Material	Unplated
---------------------------	----------

Crimp Type	F-Crimp
------------	---------

Barrel Type	Open
-------------	------

Termination Features



Product Terminates To	Wire & Cable
-----------------------	--------------

Mechanical Attachment

Wire Insulation Support	With
Mating Retention Type	Locking Lance

Dimensions

Terminal Material Thickness	.3 mm[.012 in]
Product Length	21.34 mm[.84 in]
Compatible Insulation Diameter Range	2.54 – 4.32 mm[.1 – .17 in]
Wire Size	.82 – 2.08 mm ²

Usage Conditions

Insulation Option	Uninsulated
Operating Temperature Range	-40 – 110 °C[-40 – 230 °F]

Industry Standards

Agency/Standard	CSA, UL
-----------------	---------

Packaging Features

Packaging Quantity	12000
Packaging Method	Strip/Reel

Product Compliance

[For compliance documentation, visit the product page on TE.com>](#)

EU RoHS Directive 2011/65/EU	Compliant
EU ELV Directive 2000/53/EC	Compliant
China RoHS 2 Directive MIIT Order No 32, 2016	No Restricted Materials Above Threshold
EU REACH Regulation (EC) No. 1907/2006	Current ECHA Candidate List: JUNE 2023 (235) Candidate List Declared Against: JUNE 2023 (235) Does not contain REACH SVHC
Halogen Content	Low Halogen - Br, Cl, F, I < 900 ppm per homogenous material. Also BFR/CFR/PVC Free
Solder Process Capability	Not applicable for solder process capability

Product Compliance Disclaimer

This information is provided based on reasonable inquiry of our suppliers and represents our current actual knowledge based on the information they provided. This information is subject to change. The part numbers that TE has identified as EU RoHS compliant have a maximum concentration of 0.1% by weight in homogenous materials for lead, hexavalent chromium, mercury, PBB, PBDE, DBP, BBP, DEHP, DIBP, and 0.01% for cadmium, or qualify for an exemption to these limits as defined in the Annexes of Directive 2011/65/EU (RoHS2). Finished electrical and electronic equipment products will be CE marked as required by Directive 2011/65/EU. Components may not be CE marked. Additionally, the part numbers that TE has identified as EU ELV compliant have a maximum concentration of 0.1% by weight in homogenous materials for lead, hexavalent chromium, and mercury, and 0.01% for cadmium, or qualify for an exemption to these limits as defined in the Annexes of Directive 2000/53/EC (ELV). Regarding the REACH Regulation, the information TE provides on SVHC in articles for this part number is based on the latest European Chemicals Agency (ECHA) 'Guidance on requirements for substances in articles' posted at this URL: <https://echa.europa.eu/guidance-documents/guidance-on-reach>

Compatible Parts



TE Part # 58524-1
PROCRIMPER TOOL & DIE



TE Part # 63833-1
FF 187 REC 18-14AWG BR

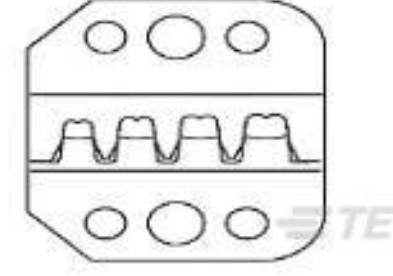

TE Part # 58524-2
PROCRIMPER DIE



TE Part # 157480-2
FF 250 REC 0.8-2MM2 TPBR



TE Part # 2-2150238-1
OCEAN_2.0_Applicator-E-110F180F



TE Part # 2-2150238-2
OCEAN_2.0_Applicator-E-110F180F



TE Part # 2-2150843-1
OCEAN_2.0_Applicator-E-100F180F



TE Part # 2-2150843-2
OCEAN_2.0_Applicator-E-100F180F



TE Part # 2150238-1
OCEAN_2.0_Applicator-E-110F180F



TE Part # 2150238-2
OCEAN_2.0_Applicator-E-110F180F



TE Part # 2150843-1
OCEAN_2.0_Applicator-E-100F180F



TE Part # 2150843-2
OCEAN_2.0_Applicator-E-100F180F



KIT
TE Part # 7-2150238-7
OCEAN_2.0_SPARE_PART_KIT-110F180F



TE Part # 7-2150843-1
OCEAN_2.0_Applicator-E-100F180F



TE Part # 7-2150843-2
OCEAN_2.0_Applicator-E-100F180F



KIT
TE Part # 7-2150843-7
OCEAN_2.0_SPARE_PART_KIT-100F180F

Also in the Series | FASTIN-FASTON 250



Crimp Terminal Housings(211)



Insertion & Extraction Tools(2)



PCB Terminals(2)

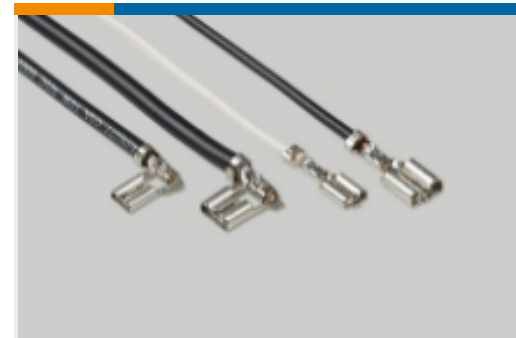

Quick Disconnects(254)

Customers Also Bought

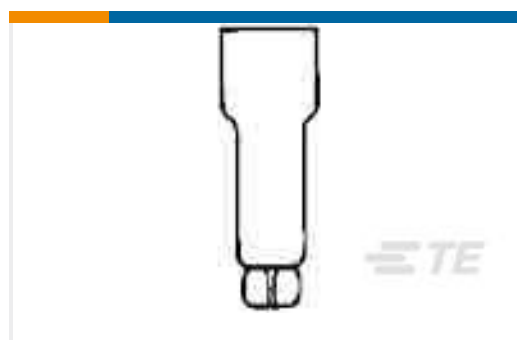
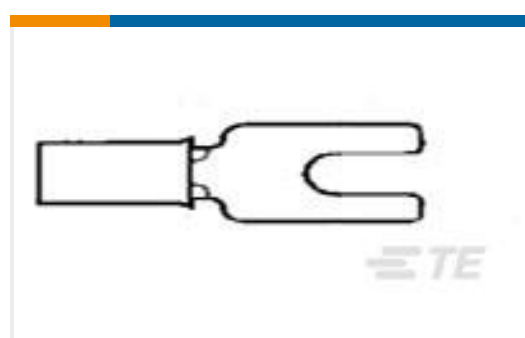
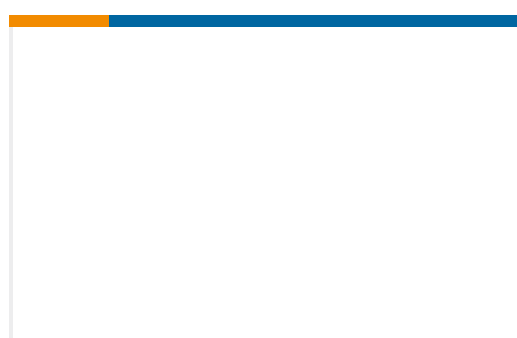
TE Part #641974-1
12P UMNL PIN HDR ASSY 94VOTE Part #4-1601140-1
053-001-000=LEADLOK2,SMZTE Part #2-36964-2
SPLICE,CE 22-14TE Part #794920-1
05P UMNL SOCKER HDR ASSY POLTE Part #35116
TERMINAL,BUDG SPD 16-14 8TE Part #1977144-4
Slide Switch DPDT dual actuator, SMT
T&RTE Part #1977145-4
Slide Switch 4PDT actuator under, SMT
T&RTE Part #2286377-1
250 FASTON,FLAG,REC.,22-18 AWG,
NPSTTE Part #HPP808H034
HTF3000LFSMDRL RH/T MODULE

Documents

Product Drawings

FF 250 REC 18-14AWG BR

English

CAD Files

3D PDF

3D



Customer View Model

[ENG_CVM_CVM_42100-1_DS_c-42100-1-ds.2d_dxf.zip](#)

English

Customer View Model

[ENG_CVM_CVM_42100-1_DS_c-42100-1-ds.3d_igs.zip](#)

English

Customer View Model

[ENG_CVM_CVM_42100-1_DS_c-42100-1-ds.3d_stp.zip](#)

English

By downloading the CAD file I accept and agree to the [Terms and Conditions](#) of use.

Datasheets & Catalog Pages

[FASTIN_FASTON_Product_Line](#)

English

[Positive Lock Receptacles](#)

English

Product Specifications

[Application Specification](#)

English

Product Environmental Compliance

[TE Material Declaration](#)

English

Instruction Sheets

[Instruction Sheet \(non U.S.\)](#)

Japanese

[Instruction Sheet \(non U.S.\)](#)

Japanese