

Omnimate Range pitch 5.00 / 5.08

Omnimate Range pitch 5.00 / 5.08

Male connectors with THR solder connection	F.2
Male connectors with solder connection	F.32
Male connectors with spade/solder connection	F.44
Male connectors with clamping yoke connection	F.46
Male connectors for terminal rail mounting with clamping yoke connection	F.48
Male connectors with TOP connection	F.50
Male connectors with tension clamp connection	F.52
Socket connectors with clamping yoke connection	F.56
Socket connectors with TOP connection	F.72
Socket connectors with leaf spring connection	F.76
Socket connectors with tension clamp connection	F.78
Socket connectors with IDC	F.88
Socket connectors with crimp connection	F.90
Socket connectors with solder connection	F.92

Male connectors with THR solder connection

SL-SMT 5.08/90 SL-SMT 5.00/90



High-temperature-resistant, 90° angled, open male connector. Packed in box or tape. In tape form with 1.5 mm solder pin optimised for automatic assembly; 3.2 mm solder pin suitable for reflow and wave soldering. Stable up to 290°C (2 x 30 s), which exceeds the requirements of EN 61760-1. These male connectors can be labelled and coded.

- 400 V (IEC) / 300 V (UL)
- 19 A (IEC) / 15 A (UL)

Derating curve

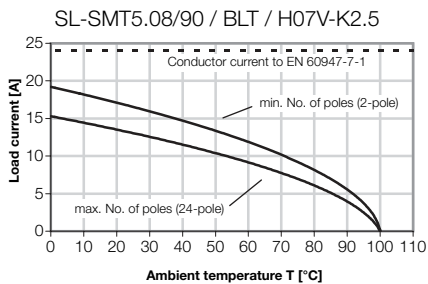
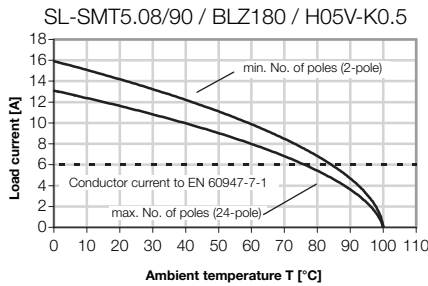
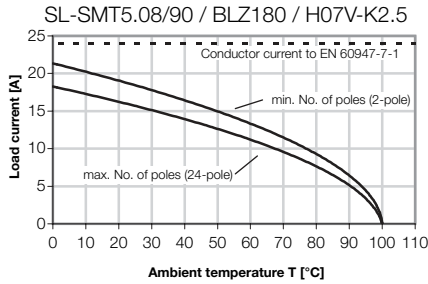

SL-SMT 5.08/90 Box SL-SMT 5.00/90 Box

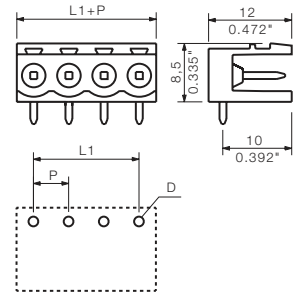

Technical data

Rated data to IEC 60664-1 / IEC 61984

Clamping range, max.	mm ²
Solid H05(07) V-U	mm ²
Stranded H07 V-R	mm ²
Flexible H05(07) V-K	mm ²
Flexible with ferrule	mm ²
Ferrule with plastic collar	mm ²
Stripping length	mm
Screwdriver blade	mm
according to norm	
Tightening torque range	Nm

Rated current

at ambient temperature	20°C	40°C
	A	A

Overtoltage category

	III	III	II
Pollution severity	3	2	2

Rated voltage

	V	320	400
Rated impulse voltage	kV	4	4

UL 1059 rated data - E60693

	B	C	D
Rated voltage	V	300	300
Rated current	A	15	10

CSA C22.2 rated data - LR12400

	B	C	D
Rated voltage	V	300	300
Rated current	A	15	10

Material data

Type of insulating material	LCP GF
Flammability class acc. UL94	V-0
Contact base material	CuSn
Material of contact surface	tinned

Information

- Additional colours on request
- Gold-plated contact surfaces on request
- Rated current related to rated cross-section and min. No. of poles.
- Hole diameter D = 1.4+0.1mm
- Hole diameter D = 1.5+0.1mm for 9 poles
- P on drg. = pitch
- Rated data refer only to the component itself. Clearance and creepage distances to other components are to be designed in accordance with the relevant application standards.

Ordering data

Solder pin length	1.5 mm	3.2 mm
Colour	black	black

Pitch 5.08 mm

Poles	L1 mm	(inch)	Qty.	Order No.	Order No.
2	5.08	(0.200)	100	1774762001	1779950000
3	10.16	(0.400)	100	1774772001	1779960000
4	15.24	(0.600)	100	1774782001	1779970000
5	20.32	(0.800)	50	1774792001	1779980000
6	25.40	(1.000)	50	1774802001	1779990000
7	30.48	(1.200)	50	1774812001	1780000000
8	35.56	(1.400)	50	1774822001	1780010000
9	40.64	(1.600)	50	1774832001	1780020000
10	45.72	(1.800)	50	1774842001	1780030000
11	50.80	(2.000)	50	1774852001	1780040000
12	55.88	(2.200)	50	1774862001	1780050000
13	60.96	(2.400)	50	1774872001	1780060000
14	66.04	(2.600)	50	1774882001	1780070000
15	71.12	(2.800)	50	1774892001	1780080000
16	76.20	(3.000)	50	1774902001	1780090000
17	81.28	(3.200)	20	1774912001	1780100000
18	86.36	(3.400)	20	1774922001	1780110000
19	91.44	(3.600)	20	1774932001	1780120000
20	96.52	(3.800)	20	1774942001	1780130000
21	101.60	(4.000)	20	1774952001	1780140000
22	106.68	(4.200)	20	1774962001	1780150000
23	111.76	(4.400)	20	1774972001	1780160000
24	116.84	(4.600)	20	1774982001	1780170000

Pitch 5.00 mm

Poles	L1 mm	(inch)	Qty.	Order No.	Order No.
2	5.00	(0.197)	100	1796930000	1839980000
3	10.00	(0.394)	100	1796940000	1839990000
4	15.00	(0.591)	100	1796950000	1839910000
5	20.00	(0.787)	50	1796960000	1839920000
6	25.00	(0.984)	50	1796970000	1839930000
7	30.00	(1.181)	50	1796980000	1839940000
8	35.00	(1.378)	50	1796990000	1839950000
9	40.00	(1.575)	50	1797000000	1839960000
10	45.00	(1.772)	50	1797010000	1839970000
11	50.00	(1.969)	50	1797020000	1839980000
12	55.00	(2.165)	50	1797030000	1839990000
13	60.00	(2.362)	50	1797040000	1840000000
14	65.00	(2.559)	50	1797050000	1840010000
15	70.00	(2.756)	50	1797060000	1840020000
16	75.00	(2.953)	50	1797070000	1840030000
17	80.00	(3.150)	20		1840040000
18	85.00	(3.346)	20		1840050000
19	90.00	(3.543)	20		1840060000
20	95.00	(3.740)	20		1840070000
21	100.00	(3.937)	20		1840080000
22	105.00	(4.134)	20		1840090000
23	110.00	(4.331)	20		1840100000
24	115.00	(4.528)	20		1840110000

SL-SMT 5.08/90 Tape
SL-SMT 5.00/90 Tape

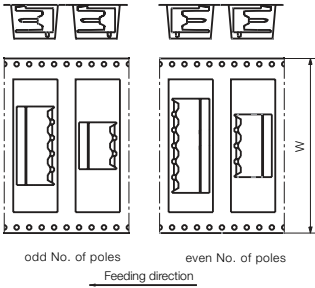

Ordering data

Solder pin length	1.5 mm
Colour	black

Pitch 5.08 mm					
Poles	L1 mm	(inch)	Qty.	Order No.	Order No.
2	5.08	(0.200)	250	1821160000	
3	10.16	(0.400)	250	1821170000	
4	15.24	(0.600)	250	1774784001	
5	20.32	(0.800)	250	1774794001	
6	25.40	(1.000)	250	1774804001	
7	30.48	(1.200)	250	1774814001	
8	35.56	(1.400)	250	1774824001	

Pitch 5.00 mm					
Poles	L1 mm	(inch)	Qty.	Order No.	Order No.
2	5.00	(0.197)	250	1797620000	
3	10.00	(0.394)	250	1797630000	
4	15.00	(0.591)	250	1797640000	
5	20.00	(0.787)	250	1797650000	
6	25.00	(0.984)	250	1797660000	
7	30.00	(1.181)	250	1797670000	
8	35.00	(1.378)	250	1797680000	

Pitch 5.08 mm: tape width W = 32 mm for max. 3 poles, otherwise 56 mm
Pitch 5.00 mm: tape width W = 56 mm

Accessories

Possible colors
Additional colours on request



Coding
See chapter accessories



Marking strips
See chapter accessories



Compartment partition element
See chapter accessories



Floodlight indicator
See chapter accessories



TRAY packaging

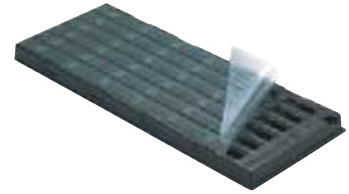

In addition to the normal cardboard box packaging and the tape on reel version, on request the SL-SMT male connectors can also be supplied packaged on trays. Filling the trays with connectors with different pole numbers is also possible on request.

The trays comply with the requirements of EN 60286-5 and are made of black, antistatic polystyrene covered with a transparent film.

Male connectors with THR solder connection

SL-SMT 5.08/90G SL-SMT 5.00/90G



High-temperature-resistant, 90° angled, closed end male connector. Packed in box or tape on reel. In tape form with 1.5 mm solder pin optimised for automatic assembly; 3.2 mm solder pin suitable for reflow and wave soldering. Stable up to 290°C (2 x 30 s), which exceeds the requirements of EN 61760-1. These male connectors can be labelled and coded.

- 400 V (IEC) / 300 V (UL)
- 19 A (IEC) / 15 A (UL)

Derating curve

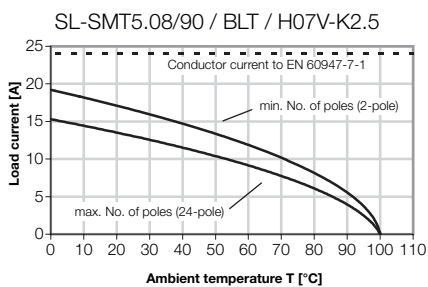
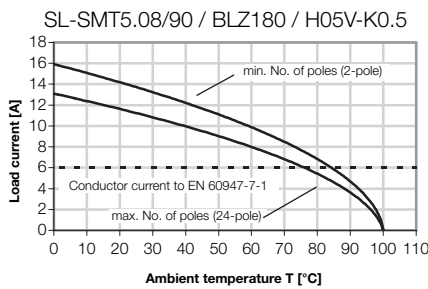
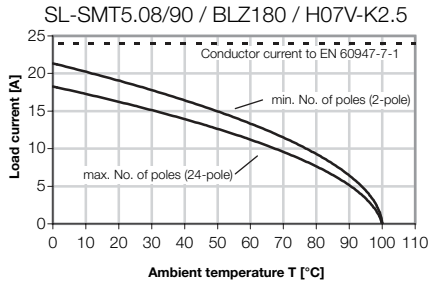

SL-SMT 5.08/90G Box SL-SMT 5.00/90G Box

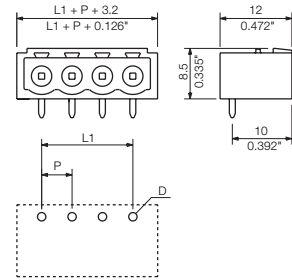

F

Technical data

Rated data to IEC 60664-1 / IEC 61984

Clamping range, max.	mm ²		
Solid H05(07) V-U	mm ²		
Stranded H07 V-R	mm ²		
Flexible H05(07) V-K	mm ²		
Flexible with ferrule	mm ²		
Ferrule with plastic collar	mm ²		
Stripping length	mm		
Screwdriver blade	mm		
according to norm			
Tightening torque range	Nm		

Rated current

at ambient temperature	20°C	40°C
	A	A
	19	16

Overvoltage category

	III	III	II
--	-----	-----	----

Pollution severity

	3	2	2
--	---	---	---

Rated voltage	V	250	320	400
Rated impulse voltage	kV	4	4	4

UL 1059 rated data - E60693

	B	C	D
--	---	---	---

Rated voltage	V	300	300
Rated current	A	15	10

CSA C22.2 rated data - LR12400 B

	B	C	D
--	---	---	---

Rated voltage	V	300	300
Rated current	A	15	10

Material data

Type of insulating material	LCP GF
Flammability class acc. UL94	V-0
Contact base material	CuSn
Material of contact surface	tinned

Information

- Additional colours on request
- Gold-plated contact surfaces on request
- Rated current related to rated cross-section and min. No. of poles.
- Hole diameter D = 1.4+0.1mm
- Hole diameter D = 1.5+0.1mm for 9 poles
- P on drg. = pitch
- Rated data refer only to the component itself. Clearance and creepage distances to other components are to be designed in accordance with the relevant application standards.

Ordering data

Solder pin length	1.5 mm	3.2 mm
Colour	black	black

Pitch 5.08 mm

Poles	L1 mm	(inch)	Qty.	Order No.	Order No.
2	5.08	(0.200)	100	1775002001	1780180000
3	10.16	(0.400)	100	1775012001	1780190000
4	15.24	(0.600)	100	1775022001	1780200000
5	20.32	(0.800)	50	1775032001	1780210000
6	25.40	(1.000)	50	1775042001	1780220000
7	30.48	(1.200)	50	1775052001	1780230000
8	35.56	(1.400)	50	1775062001	1780240000
9	40.64	(1.600)	50	1775072001	1780250000
10	45.72	(1.800)	50	1775082001	1780260000
11	50.80	(2.000)	50	1775092001	1780270000
12	55.88	(2.200)	50	1775102001	1780280000
13	60.96	(2.400)	50	1775112001	1780290000
14	66.04	(2.600)	50	1775122001	1780300000
15	71.12	(2.800)	50	1775132001	1780310000
16	76.20	(3.000)	50	1775142001	1780320000
17	81.28	(3.200)	20	1775152001	1780330000
18	86.36	(3.400)	20	1775162001	1780340000
19	91.44	(3.600)	20	1775172001	1780350000
20	96.52	(3.800)	20	1775182001	1780360000
21	101.60	(4.000)	20	1775192001	1780370000
22	106.68	(4.200)	20	1775202001	1780380000
23	111.76	(4.400)	20	1775212001	1780390000
24	116.84	(4.600)	20	1775222001	1780400000

Pitch 5.00 mm

Poles	L1 mm	(inch)	Qty.	Order No.	Order No.
2	5.00	(0.197)	100	1797080000	1840120000
3	10.00	(0.394)	100	1797090000	1840130000
4	15.00	(0.591)	100	1797100000	1840140000
5	20.00	(0.787)	50	1797110000	1840150000
6	25.00	(0.984)	50	1797120000	1840160000
7	30.00	(1.181)	50	1797130000	1840170000
8	35.00	(1.378)	50	1797140000	1840180000
9	40.00	(1.575)	50	1797150000	1840190000
10	45.00	(1.772)	50	1797160000	1840200000
11	50.00	(1.969)	50	1797170000	1840210000
12	55.00	(2.165)	50	1797180000	1840220000
13	60.00	(2.362)	50	1797190000	1840230000
14	65.00	(2.559)	50	1797200000	1840240000
15	70.00	(2.756)	50	1797210000	1840250000
16	75.00	(2.953)	50	1797220000	1840260000
17	80.00	(3.150)	20		1840270000
18	85.00	(3.346)	20		1840280000
19	90.00	(3.543)	20		1840290000
20	95.00	(3.740)	20		1840300000
21	100.00	(3.937)	20		1840310000
22	105.00	(4.134)	20		1840320000
23	110.00	(4.331)	20		1840330000
24	115.00	(4.528)	20		1840340000

SL-SMT 5.08/90G Tape
SL-SMT 5.00/90G Tape

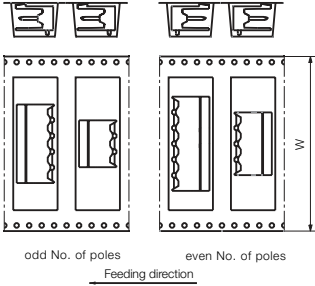

Ordering data

Solder pin length	1.5 mm
Colour	black

Pitch 5.08 mm					
Poles	L1 mm	(inch)	Qty.	Order No.	Order No.
2	5.08	(0.200)	250	1821140000	
3	10.16	(0.400)	250	1775014001	
4	15.24	(0.600)	250	1775024001	
5	20.32	(0.800)	250	1775034001	
6	25.40	(1.000)	250	1775044001	
7	30.48	(1.200)	250	1775054001	

Pitch 5.00 mm					
Poles	L1 mm	(inch)	Qty.	Order No.	Order No.
2	5.00	(0.197)	250	1797690000	
3	10.00	(0.394)	250	1797700000	
4	15.00	(0.591)	250	1797710000	
5	20.00	(0.787)	250	1797720000	
6	25.00	(0.984)	250	1797730000	
7	30.00	(1.181)	250	1797740000	

Pitch 5.08 mm: tape width W = 32 mm for 2 poles, otherwise 56 mm
Pitch 5.00 mm: tape width W = 56 mm

Accessories

Possible colors

Additional colours on request



Coding

See chapter accessories



Marking strips

See chapter accessories



Compartment partition element

See chapter accessories



Floodlight indicator

See chapter accessories



TRAY packaging

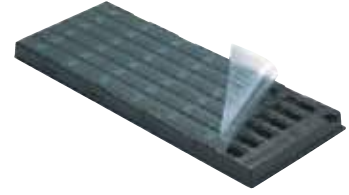

In addition to the normal cardboard box packaging and the tape on reel version, on request the SL-SMT male connectors can also be supplied packaged on trays. Filling the trays with connectors with different pole numbers is also possible on request.

The trays comply with the requirements of EN 60286-5 and are made of black, antistatic polystyrene covered with a transparent film.

Male connectors with THR solder connection

SL-SMT 5.08/90F SL-SMT 5.00/90F



High-temperature-resistant, 90° angled, male connector with flange. Packed in box. 3.2 mm solder pin suitable for reflow and wave soldering. Stable up to 290°C (2 x 30 s), which exceeds the requirements of EN 61760-1. These male connectors can be labelled and coded.

- 400 V (IEC) / 300 V (UL)
- 19 A (IEC) / 15 A (UL)

Derating curve

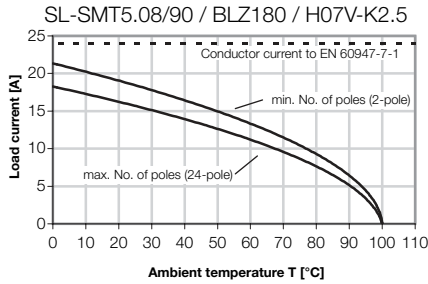

SL-SMT 5.08/90F Box

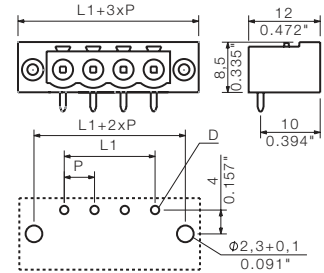

F

Technical data

Rated data to IEC 60664-1 / IEC 61984

Clamping range, max.	mm ²		
Solid H05(07) V-U	mm ²		
Stranded H07 V-R	mm ²		
Flexible H05(07) V-K	mm ²		
Flexible with ferrule	mm ²		
Ferrule with plastic collar	mm ²		
Stripping length	mm		
Screwdriver blade	mm		
according to norm			
Tightening torque range	Nm		

Rated current at ambient temperature

	20°C	40°C
A	19	16

Overvoltage category Pollution severity

	III	III	II
	3	2	2

Rated voltage	V	250	320	400
Rated impulse voltage	kV	4	4	4

UL 1059 rated data - E60693

	B	C	D
Rated voltage	V	300	300
Rated current	A	15	10

CSA C22.2 rated data - LR12400

	B	C	D
Rated voltage	V	300	300
Rated current	A	15	10

Material data

Type of insulating material	LCP GF
Flammability class acc. UL94	V-0
Contact base material	CuSn
Material of contact surface	tinned

Information

- Additional colours on request
- Gold-plated contact surfaces on request
- Rated current related to rated cross-section and min. No. of poles.
- Hole diameter D = 1.4+0.1mm
- Hole diameter D = 1.5+0.1mm for 9 poles
- P on drg. = pitch
- Rated data refer only to the component itself. Clearance and creepage distances to other components are to be designed in accordance with the relevant application standards.

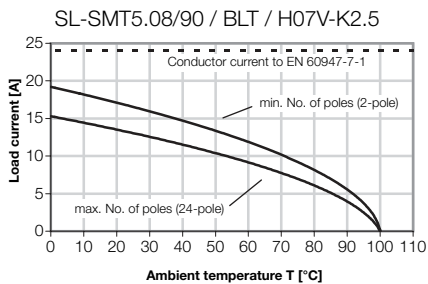
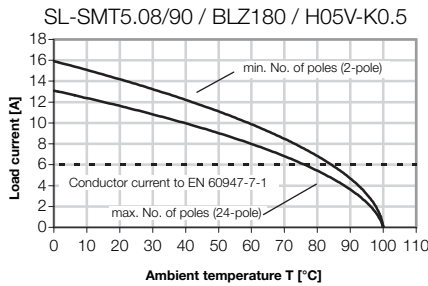

Ordering data

Solder pin length		3.2 mm	
Colour		black	
Pitch 5.08 mm			
Poles	L1 mm (inch)	Qty.	Order No.
2	5.08 (0.200)	100	1837630000
3	10.16 (0.400)	100	1837640000
4	15.24 (0.600)	100	1837650000
5	20.32 (0.800)	50	1837660000
6	25.40 (1.000)	50	1837670000
7	30.48 (1.200)	50	1837680000
8	35.56 (1.400)	50	1837690000
9	40.64 (1.600)	50	1837700000
10	45.72 (1.800)	50	1837710000
11	50.80 (2.000)	50	1837720000
12	55.88 (2.200)	50	1837730000
13	60.96 (2.400)	50	1837740000
14	66.04 (2.600)	50	1837750000
15	71.12 (2.800)	50	1837760000
16	76.20 (3.000)	50	1837770000
17	81.28 (3.200)	20	1837780000
18	86.36 (3.400)	20	1837790000
19	91.44 (3.600)	20	1837800000
20	96.52 (3.800)	20	1837810000
21	101.60 (4.000)	20	1837820000
22	106.68 (4.200)	20	1837830000
23	111.76 (4.400)	20	1837840000
24	116.84 (4.600)	20	1837850000

Accessories

Possible colors

Additional colours on request



Coding

See chapter accessories



Marking strips

See chapter accessories



Compartment partition element

See chapter accessories



Floodlight indicator

See chapter accessories



Male connectors with THR solder connection

SL-SMT 5.08/90LF SL-SMT 5.00/90LF



High-temperature-resistant, 90° angled, male connector with solder flange. Packed in box or tape. In tape form with 1.5 mm solder pin optimised for automatic assembly; 3.2 mm solder pin suitable for reflow and wave soldering. Stable up to 290°C (2 x 30 s), which exceeds the requirements of EN 61760-1. These male connectors can be labelled and coded.

- 400 V (IEC) / 300 V (UL)
- 19 A (IEC) / 15 A (UL)

Derating curve

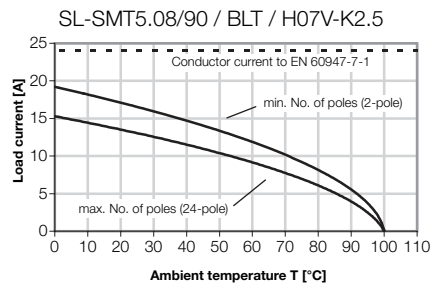
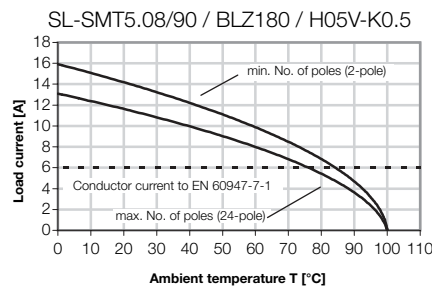
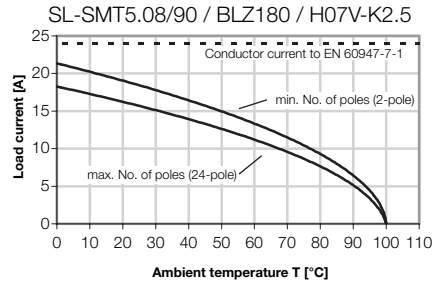

SL-SMT 5.08/90LF Box SL-SMT 5.00/90LF Box

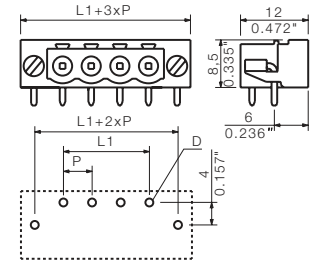

Ordering data

Solder pin length	1.5 mm	3.2 mm
Colour	black	black

Pitch 5.08 mm					
Poles	L1 mm	(inch)	Qty.	Order No.	Order No.
2	5.08	(0.200)	100	1775232001	1780410000
3	10.16	(0.400)	100	1775242001	1780420000
4	15.24	(0.600)	100	1775252001	1780430000
5	20.32	(0.800)	50	1775262001	1780440000
6	25.40	(1.000)	50	1775272001	1780450000
7	30.48	(1.200)	50	1775282001	1780460000
8	35.56	(1.400)	50	1775292001	1780470000
9	40.64	(1.600)	50	1775302001	1780480000
10	45.72	(1.800)	50	1775312001	1780490000
11	50.80	(2.000)	50	1775322001	1780500000
12	55.88	(2.200)	50	1775332001	1780510000
13	60.96	(2.400)	50	1775342001	1780540000
14	66.04	(2.600)	50	1775352001	1780550000
15	71.12	(2.800)	50	1775362001	1780560000
16	76.20	(3.000)	50	1775372001	1780570000
17	81.28	(3.200)	20	1775382001	1780580000
18	86.36	(3.400)	20	1775392001	1780590000
19	91.44	(3.600)	20	1775402001	1780600000
20	96.52	(3.800)	20	1775412001	1780610000
21	101.60	(4.000)	20	1775422001	1780620000
22	106.68	(4.200)	20	1775432001	1780630000
23	111.76	(4.400)	20	1775442001	1780640000
24	116.84	(4.600)	20	1775452001	1780650000

Pitch 5.00 mm					
Poles	L1 mm	(inch)	Qty.	Order No.	Order No.
2	5.00	(0.197)	100	1797230000	1840350000
3	10.00	(0.394)	100	1797240000	1840360000
4	15.00	(0.591)	100	1797250000	1840370000
5	20.00	(0.787)	50	1797260000	1840380000
6	40.00	(1.575)	50	1797270000	1840390000
7	30.00	(1.181)	50	1797280000	1840400000
8	35.00	(1.378)	50	1797290000	1840410000
9	40.00	(1.575)	50	1797300000	1840420000
10	45.00	(1.772)	50	1797310000	1840430000
11	50.00	(1.969)	50	1797320000	1840440000
12	55.00	(2.165)	50	1797330000	1840450000
13	60.00	(2.362)	50	1797340000	1840460000
14	65.00	(2.559)	50	1797350000	1840470000
15	70.00	(2.756)	50	1797360000	1840480000
16	75.00	(2.953)	50	1797370000	1840490000
17	80.00	(3.150)	20		1840500000
18	85.00	(3.346)	20		1840510000
19	90.00	(3.543)	20		1840520000
20	95.00	(3.740)	20		1840530000
21	100.00	(3.937)	20		1840540000
22	105.00	(4.134)	20		1840550000
23	110.00	(4.331)	20		1840560000
24	115.00	(4.528)	20		1840570000

Technical data

Rated data to IEC 60664-1 / IEC 61984			
Clamping range, max.	mm ²		
Solid H05(07) V-U	mm ²		
Stranded H07 V-R	mm ²		
Flexible H05(07) V-K	mm ²		
Flexible with ferrule	mm ²		
Ferrule with plastic collar	mm ²		
Stripping length	mm		
Screwdriver blade	mm		
according to norm			
Tightening torque range	Nm		
Rated current at ambient temperature			
		20°C	40°C
	A	19	16
Overvoltage category			
		III	II
Pollution severity			
		3	2
Rated voltage	V	250	320
Rated impulse voltage	kV	4	4
UL 1059 rated data - E60693			
		B	C
Rated voltage	V	300	300
Rated current	A	15	10
AWG conductor			
CSA C22.2 rated data - LR12400 B			
		B	D
Rated voltage	V	300	300
Rated current	A	15	10
AWG conductor			
Material data			
Type of insulating material		LCP GF	
Flammability class acc. UL94		V-0	
Contact base material		CuSn	
Material of contact surface		tinned	

- Information**
- Additional colours on request
 - Gold-plated contact surfaces on request
 - Rated current related to rated cross-section and min. No. of poles.
 - Hole diameter D = 1.4+0.1mm
 - Hole diameter D = 1.5+0.1mm for 9 poles
 - P on drg. = pitch
 - Rated data refer only to the component itself. Clearance and creepage distances to other components are to be designed in accordance with the relevant application standards.

SL-SMT 5.08/90LF Tape
SL-SMT 5.00/90LF Tape

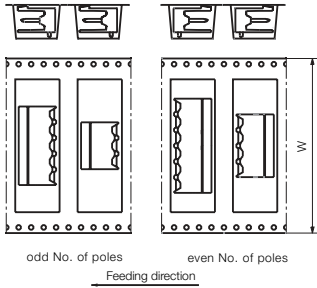

Ordering data

Solder pin length	1.5 mm
Colour	black

Pitch 5.08 mm					
Poles	L1 mm	(inch)	Qty.	Order No.	Order No.
2	5.08	(0.200)	250	1775234001	
3	10.16	(0.400)	250	1775244001	
4	15.24	(0.600)	250	1775254001	
5	20.32	(0.800)	250	1775264001	
6	25.40	(1.000)	250	1775274001	

Pitch 5.00 mm					
Poles	L1 mm	(inch)	Qty.	Order No.	Order No.
2	5.00	(0.197)	250	1797750000	
3	10.00	(0.394)	250	1797760000	
4	15.00	(0.591)	250	1797770000	
5	20.00	(0.787)	250	1797780000	
6	25.00	(0.984)	250	1797790000	

Pitch 5.08 mm: tape width W = 56 mm
Pitch 5.00 mm: tape width W = 56 mm

Accessories

Possible colors

Additional colours on request



Coding

See chapter accessories



Marking strips

See chapter accessories



Compartment partition element

See chapter accessories



Floodlight indicator

See chapter accessories



TRAY packaging

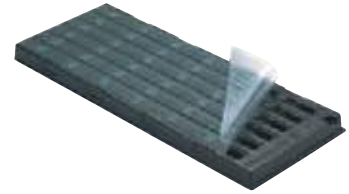

In addition to the normal cardboard box packaging and the tape on reel version, on request the SL-SMT male connectors can also be supplied packaged on trays. Filling the trays with connectors with different pole numbers is also possible on request.

The trays comply with the requirements of EN 60286-5 and are made of black, antistatic polystyrene covered with a transparent film.

Male connectors with THR solder connection

SL-SMT 5.08/180 SL-SMT 5.00/180



High-temperature-resistant, straight, open ended male connector. Packed in box or tape on reel. In tape with 1.5 mm solder pin optimised for automatic assembly. 3.2 mm solder pin suitable for reflow and wave soldering. Stable up to 290°C (2 x 30 s), which exceeds the requirements of EN 61760-1. These male connectors can be labelled and coded.

- 400 V (IEC) / 300 V (UL)
- 19 A (IEC) / 15 A (UL)

Derating curve

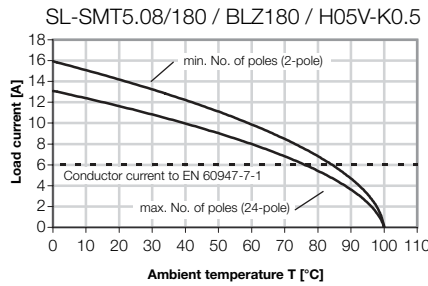
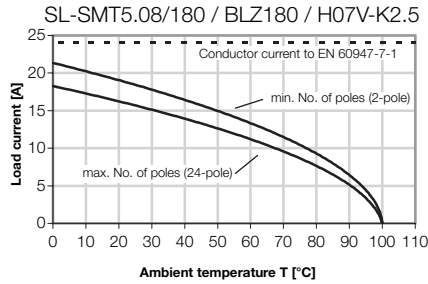

SL-SMT 5.08/180 Box SL-SMT 5.00/180 Box

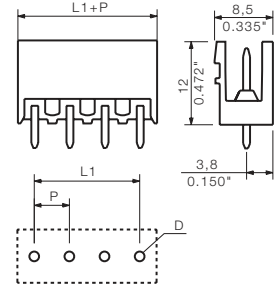

Technical data

Rated data to IEC 60664-1 / IEC 61984

Clamping range, max.	mm ²
Solid H05(07) V-U	mm ²
Stranded H07 V-R	mm ²
Flexible H05(07) V-K	mm ²
Flexible with ferrule	mm ²
Ferrule with plastic collar	mm ²
Stripping length	mm
Screwdriver blade	mm
according to norm	
Tightening torque range	Nm

Rated current

at ambient temperature	20°C	40°C
A	19	16

Overvoltage category

	III	III	II
--	-----	-----	----

Pollution severity

	3	2	2
--	---	---	---

Rated voltage	V	250	320	400
Rated impulse voltage	kV	4	4	4

UL 1059 rated data - E60693

	B	C	D
Rated voltage	V	300	300
Rated current	A	15	10
AWG conductor			

CSA C22.2 rated data - LR12400 B

	B	C	D
Rated voltage	V	300	300
Rated current	A	15	10
AWG conductor			

Material data

Type of insulating material	LCP GF
Flammability class acc. UL94	V-0
Contact base material	CuSn
Material of contact surface	tinned

Information

- Additional colours on request
- Gold-plated contact surfaces on request
- Rated current related to rated cross-section and min. No. of poles.
- Hole diameter D = 1.4+0.1mm
- Hole diameter D = 1.5+0.1mm for 9 poles
- P on drg. = pitch
- Rated data refer only to the component itself. Clearance and creepage distances to other components are to be designed in accordance with the relevant application standards.

Ordering data

Solder pin length	1.5 mm	3.2 mm
Colour	black	black

Pitch 5.08 mm

Poles	L1 mm	(inch)	Qty.	Order No.	Order No.
2	5.08	(0.200)	100	1775522001	1837980000
3	10.16	(0.400)	100	1775572001	1837990000
4	15.24	(0.600)	100	1775592001	1838000000
5	20.32	(0.800)	50	1775632001	1838010000
6	25.40	(1.000)	50	1775642001	1838020000
7	30.48	(1.200)	50	1775652001	1838030000
8	35.56	(1.400)	50	1775662001	1838040000
9	40.64	(1.600)	50	1775672001	1838050000
10	45.72	(1.800)	50	1775682001	1838060000
11	50.80	(2.000)	50	1775692001	1838070000
12	55.88	(2.200)	50	1775702001	1838080000
13	60.96	(2.400)	50	1775712001	1838090000
14	66.04	(2.600)	50	1775722001	1838100000
15	71.12	(2.800)	50	1775732001	1838110000
16	76.20	(3.000)	50	1775742001	1838120000
17	81.28	(3.200)	20	1775752001	1838130000
18	86.36	(3.400)	20	1775762001	1838140000
19	91.44	(3.600)	20	1775772001	1838150000
20	96.52	(3.800)	20	1775782001	1838160000
21	101.60	(4.000)	20	1775792001	1838170000
22	106.68	(4.200)	20	1775802001	1838180000
23	111.76	(4.400)	20	1775812001	1838190000
24	116.84	(4.600)	20	1775822001	1838200000

Pitch 5.00 mm

Poles	L1 mm	(inch)	Qty.	Order No.	Order No.
2	5.00	(0.197)	100	1796480000	1840920000
3	10.00	(0.394)	100	1796490000	1840930000
4	15.00	(0.591)	100	1796500000	1840940000
5	20.00	(0.787)	50	1796510000	1840950000
6	25.00	(0.984)	50	1796520000	1840960000
7	30.00	(1.181)	50	1796530000	1840970000
8	35.00	(1.378)	50	1796540000	1840980000
9	40.00	(1.575)	50	1796550000	1840990000
10	45.00	(1.772)	50	1796560000	1841000000
11	50.00	(1.969)	50	1796570000	1841020000
12	55.00	(2.165)	50	1796580000	1841030000
13	60.00	(2.362)	50	1796590000	1841040000
14	65.00	(2.559)	50	1796600000	1841050000
15	70.00	(2.756)	50	1796610000	1841060000
16	75.00	(2.953)	50	1796620000	1841070000
17	80.00	(3.150)	20		1841080000
18	85.00	(3.346)	20		1841090000
19	90.00	(3.543)	20		1841100000
20	95.00	(3.740)	20		1841110000
21	100.00	(3.937)	20		1841120000
22	105.00	(4.134)	20		1841130000
23	110.00	(4.331)	20		1841140000
24	115.00	(4.528)	20		1841150000

SL-SMT 5.08/180 Tape
SL-SMT 5.00/180 Tape

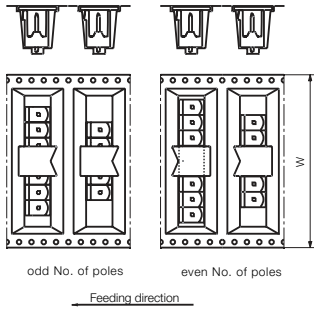

Accessories

Possible colors

Additional colours on request



Coding

See chapter accessories

TRAY packaging

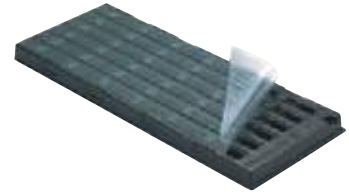

In addition to the normal cardboard box packaging and the tape on reel version, on request the SL-SMT male connectors can also be supplied packaged on trays. Filling the trays with connectors with different pole numbers is also possible on request.

The trays comply with the requirements of EN 60286-5 and are made of black, antistatic polystyrene covered with a transparent film.

Ordering data

Solder pin length	1.5 mm
Colour	black

Pitch 5.08 mm

Poles	L1 mm	(inch)	Qty.	Order No.	Order No.
2	5.08	(0.200)	200	1821100000	
3	10.16	(0.400)	265	1821110000	
4	15.24	(0.600)	200	1775594001	
5	20.32	(0.800)	265	1775634001	
6	25.40	(1.000)	265	1775644001	
7	30.48	(1.200)	265	1775654001	
8	35.56	(1.400)	200	1775664001	

Pitch 5.00 mm

Poles	L1 mm	(inch)	Qty.	Order No.	Order No.
2	5.00	(0.197)	200	1797800000	
3	10.00	(0.394)	200	1797810000	
4	15.00	(0.591)	200	1797820000	
5	20.00	(0.787)	200	1797830000	
6	25.00	(0.984)	200	1797840000	
7	30.00	(1.181)	200	1797850000	
8	35.00	(1.378)	200	1797860000	

Pitch 5.08 mm: tape width W = 32 mm for max. 3 poles, otherwise 56 mm
Pitch 5.00 mm: tape width W = 56 mm



Marking strips

See chapter accessories



Compartment partition element

See chapter accessories



Male connectors with THR solder connection

SL-SMT 5.08/180G SL-SMT 5.00/180G



High-temperature-resistant, straight, closed ended. Packed in box or tape on reel. In tape with 1.5 mm solder pin optimised for automatic assembly. 3.2 mm solder pin suitable for reflow and wave soldering. Stable up to 290°C (2 x 30 s), which exceeds the requirements of EN 61760-1. These male connectors can be labelled and coded.

- 400 V (IEC) / 300 V (UL)
- 19 A (IEC) / 15 A (UL)

Derating curve

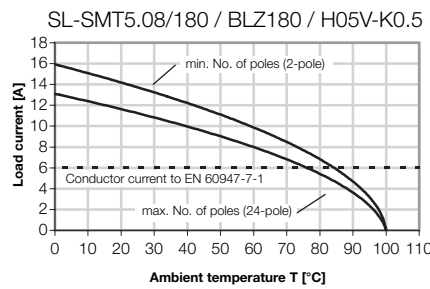
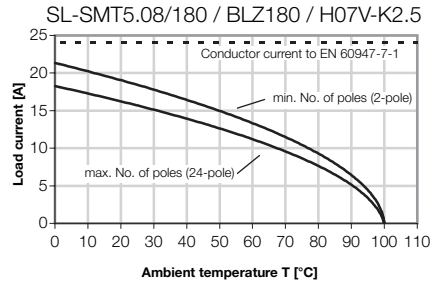

SL-SMT 5.08/180G Box SL-SMT 5.00/180G Box

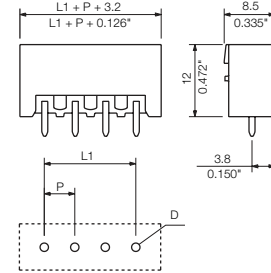

F

Technical data

Rated data to IEC 60664-1 / IEC 61984

Clamping range, max.	mm ²
Solid H05(07) V-U	mm ²
Stranded H07 V-R	mm ²
Flexible H05(07) V-K	mm ²
Flexible with ferrule	mm ²
Ferrule with plastic collar	mm ²
Stripping length	mm
Screwdriver blade	mm
according to norm	
Tightening torque range	Nm

Rated current

at ambient temperature	20°C	40°C
A	19	16

Overvoltage category

III	III	II
-----	-----	----

Pollution severity

3	2	2
---	---	---

Rated voltage	V	250	320	400
Rated impulse voltage	kV	4	4	4

UL 1059 rated data - E60693

	B	C	D
Rated voltage	V	300	300
Rated current	A	15	10
AWG conductor			

CSA C22.2 rated data - LR12400 B

	B	C	D
Rated voltage	V	300	300
Rated current	A	15	10
AWG conductor			

Material data

Type of insulating material	LCP GF
Flammability class acc. UL94	V-0
Contact base material	CuSn
Material of contact surface	tinned

Information

- Additional colours on request
- Gold-plated contact surfaces on request
- Rated current related to rated cross-section and min. No. of poles.
- Hole diameter D = 1.4+0.1mm
- Hole diameter D = 1.5+0.1mm for 9 poles
- P on drg. = pitch
- Rated data refer only to the component itself. Clearance and creepage distances to other components are to be designed in accordance with the relevant application standards.

Ordering data

Solder pin length	1.5 mm	3.2 mm
Colour	black	black

Pitch 5.08 mm

Poles	L1 mm	(inch)	Qty.	Order No.	Order No.
2	5.08	(0.200)	100	1775922001	1838210000
3	10.16	(0.400)	100	1775932001	1838220000
4	15.24	(0.600)	100	1775942001	1838230000
5	20.32	(0.800)	50	1775952001	1838240000
6	25.40	(1.000)	50	1775962001	1838250000
7	30.48	(1.200)	50	1775972001	1838260000
8	35.56	(1.400)	50	1775982001	1838270000
9	40.64	(1.600)	50	1775992001	1838280000
10	45.72	(1.800)	50	1776002001	1838290000
11	50.80	(2.000)	50	1776012001	1838300000
12	55.88	(2.200)	50	1776022001	1838310000
13	60.96	(2.400)	50	1776032001	1838320000
14	66.04	(2.600)	50	1776042001	1838330000
15	71.12	(2.800)	50	1776052001	1838340000
16	76.20	(3.000)	50	1776062001	1838350000
17	81.28	(3.200)	20	1776072001	1838360000
18	86.36	(3.400)	20	1776082001	1838370000
19	91.44	(3.600)	20	1776092001	1838380000
20	96.52	(3.800)	20	1776102001	1838390000
21	101.60	(4.000)	20	1776112001	1838400000
22	106.68	(4.200)	20	1776122001	1838410000
23	111.76	(4.400)	20	1776132001	1838420000
24	116.84	(4.600)	20	1776142001	1838430000

Pitch 5.00 mm

Poles	L1 mm	(inch)	Qty.	Order No.	Order No.
2	5.00	(0.197)	100	1796630000	1841160000
3	10.00	(0.394)	100	1796640000	1841170000
4	15.00	(0.591)	100	1796650000	1841180000
5	20.00	(0.787)	50	1796660000	1841190000
6	25.00	(0.984)	50	1796670000	1841200000
7	30.00	(1.181)	50	1796680000	1841210000
8	35.00	(1.378)	50	1796690000	1841220000
9	40.00	(1.575)	50	1796700000	1841230000
10	45.00	(1.772)	50	1796710000	1841240000
11	50.00	(1.969)	50	1796720000	1841250000
12	55.00	(2.165)	50	1796730000	1841260000
13	60.00	(2.362)	50	1796740000	1841270000
14	65.00	(2.559)	50	1796750000	1841280000
15	70.00	(2.756)	50	1796760000	1841290000
16	75.00	(2.953)	50	1796770000	1841300000
17	80.00	(3.150)	20		1841310000
18	85.00	(3.346)	20		1841320000
19	90.00	(3.543)	20		1841330000
20	95.00	(3.740)	20		1841340000
21	100.00	(3.937)	20		1841350000
22	105.00	(4.134)	20		1841360000
23	110.00	(4.331)	20		1841370000
24	115.00	(4.528)	20		1841380000

SL-SMT 5.08/180G Tape
SL-SMT 5.00/180G Tape

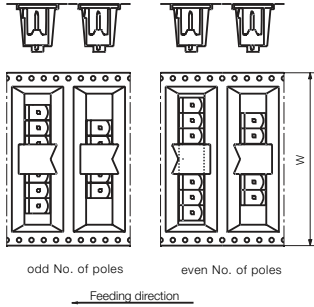

Ordering data

Solder pin length	1.5 mm
Colour	black

Pitch 5.08 mm

Poles	L1 mm	(inch)	Qty.	Order No.	Order No.
2	5.08	(0.200)	200	1820170000	
3	10.16	(0.400)	200	1775934001	
4	15.24	(0.600)	200	1775944001	
5	20.32	(0.800)	200	1775954001	
6	25.40	(1.000)	200	1775964001	
7	30.48	(1.200)	200	1775974001	

Pitch 5.00 mm

Poles	L1 mm	(inch)	Qty.	Order No.	Order No.
2	5.00	(0.197)	200	1797870000	
3	10.00	(0.394)	200	1797880000	
4	15.00	(0.591)	200	1797890000	
5	20.00	(0.787)	200	1797900000	
6	25.00	(0.984)	200	1797910000	
7	30.00	(1.181)	200	1797920000	

Pitch 5.08 mm: tape width W = 32 mm for 2 poles, otherwise 56 mm
Pitch 5.00 mm: tape width W = 56 mm

Accessories

Possible colors

Additional colours on request



Coding

See chapter accessories



Marking strips

See chapter accessories



Compartment partition element

See chapter accessories



TRAY packaging

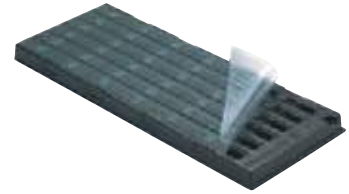

In addition to the normal cardboard box packaging and the tape on reel version, on request the SL-SMT male connectors can also be supplied packaged on trays. Filling the trays with connectors with different pole numbers is also possible on request.

The trays comply with the requirements of EN 60286-5 and are made of black, antistatic polystyrene covered with a transparent film.

Male connectors with THR solder connection

SL-SMT 5.08/180F SL-SMT 5.00/180F

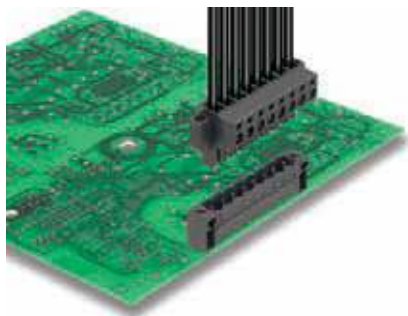

High-temperature-resistant, straight, male connector with flange. Packed in a box or tape on reel. In tape with 1.5 mm solder pin optimised for automatic assembly. 3.2 mm solder pin suitable for reflow and wave soldering. Stable up to 290°C (2 x 30 s), which exceeds the requirements of EN 61760-1. These male connectors can be labelled and coded.

- 400 V (IEC) / 300 V (UL)
- 19 A (IEC) / 15 A (UL)

Derating curve

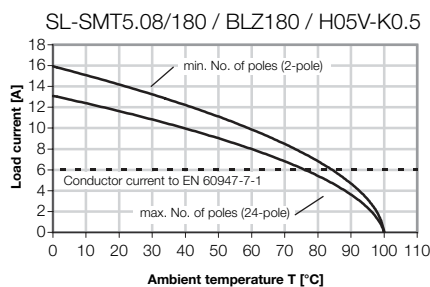
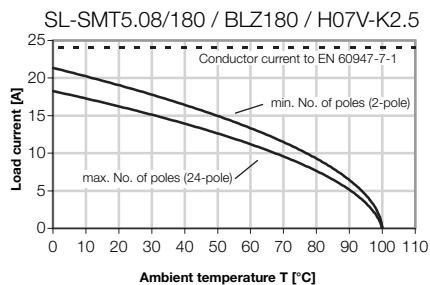

SL-SMT 5.08/180F Box

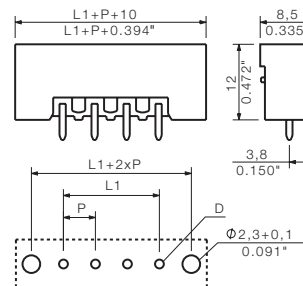

F

Technical data

Rated data to IEC 60664-1 / IEC 61984			
Clamping range, max.	mm ²		
Solid H05(07) V-U	mm ²		
Stranded H07 V-R	mm ²		
Flexible H05(07) V-K	mm ²		
Flexible with ferrule	mm ²		
Ferrule with plastic collar	mm ²		
Stripping length	mm		
Screwdriver blade	mm		
according to norm			
Tightening torque range	Nm		
Rated current at ambient temperature		20°C	40°C
	A	19	16
Overvoltage category		III	III
Pollution severity		3	2
Rated voltage	V	250	320
Rated impulse voltage	kV	4	4
UL 1059 rated data - E60693		B	C
Rated voltage	V	300	300
Rated current	A	15	10
AWG conductor			
CSA C22.2 rated data - LR12400 B		B	C
Rated voltage	V	300	300
Rated current	A	15	10
AWG conductor			
Material data			
Type of insulating material		LCP GF	
Flammability class acc. UL94		V-0	
Contact base material		CuSn	
Material of contact surface		tinned	

- Information**
- Additional colours on request
 - Gold-plated contact surfaces on request
 - Rated current related to rated cross-section and min. No. of poles.
 - Hole diameter D = 1.4+0.1mm
 - Hole diameter D = 1.5+0.1mm for 9 poles
 - P on drg. = pitch
 - Rated data refer only to the component itself. Clearance and creepage distances to other components are to be designed in accordance with the relevant application standards.

Ordering data

Solder pin length		3.2 mm		
Colour		black		
Pitch 5.08 mm				
Poles	L1 mm	(inch)	Qty.	Order No.
2	5.08	(0.200)	100	1837860000
3	10.16	(0.400)	100	1820600000
4	15.24	(0.600)	100	1837870000
5	20.32	(0.800)	50	1820770000
6	25.40	(1.000)	50	1820610000
7	30.48	(1.200)	50	1837880000
8	35.56	(1.400)	50	1820620000
9	40.64	(1.600)	50	1837890000
10	45.72	(1.800)	50	1820780000
11	50.80	(2.000)	50	1837900000
12	55.88	(2.200)	50	1820630000
13	60.96	(2.400)	50	1820790000
14	66.04	(2.600)	50	1820800000
15	71.12	(2.800)	50	1837910000
16	76.20	(3.000)	50	1820640000
17	81.28	(3.200)	20	1837920000
18	86.36	(3.400)	20	1820650000
19	91.44	(3.600)	20	1837930000
20	96.52	(3.800)	20	1820810000
21	101.60	(4.000)	20	1837940000
22	106.68	(4.200)	20	1837950000
23	111.76	(4.400)	20	1837960000
24	116.84	(4.600)	20	1837970000

Accessories

Possible colors

Additional colours on request



Coding

See chapter accessories



Marking strips

See chapter accessories



Compartment partition element

See chapter accessories



Male connectors with THR solder connection

SL-SMT 5.08/180LF SL-SMT 5.00/180LF



High-temperature-resistant, straight, male connector with solder flange. Packed in a box or tape on reel. In tape with 1.5 mm solder pin optimised for automatic assembly. 3.2 mm solder pin suitable for reflow and wave soldering. Stable up to 290°C (2 x 30 s), which exceeds the requirements of EN 61760-1. These male connectors can be labelled and coded.

- 400 V (IEC) / 300 V (UL)
- 19 A (IEC) / 15 A (UL)

Derating curve

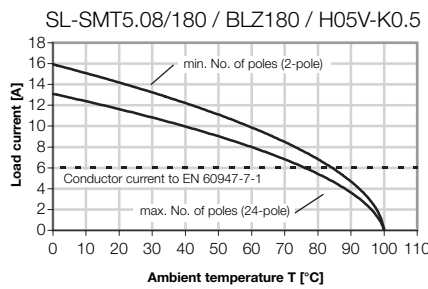
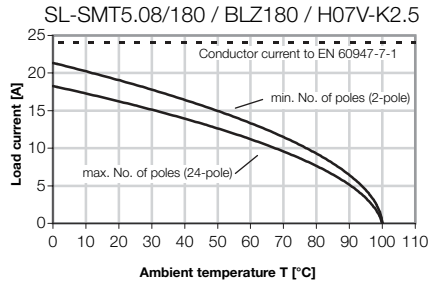

SL-SMT 5.08/180LF Box SL-SMT 5.00/180LF Box

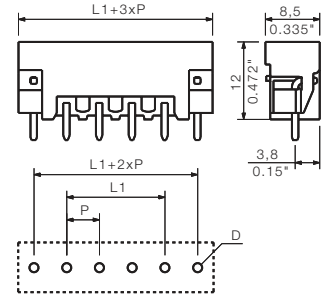

Ordering data

Solder pin length	1.5 mm	3.2 mm
Colour	black	black

Pitch 5.08 mm

Poles	L1 mm	(inch)	Qty.	Order No.	Order No.
2	5.08	(0.200)	100	1776362001	1838440000
3	10.16	(0.400)	100	1776372001	1838450000
4	15.24	(0.600)	100	1776382001	1838460000
5	20.32	(0.800)	50	1776392001	1838470000
6	25.40	(1.000)	50	1776402001	1838480000
7	30.48	(1.200)	50	1776412001	1838490000
8	35.56	(1.400)	50	1776422001	1838500000
9	40.64	(1.600)	50	1776432001	1838510000
10	45.72	(1.800)	50	1776442001	1838520000
11	50.80	(2.000)	50	1776452001	1838530000
12	55.88	(2.200)	50	1776462001	1838540000
13	60.96	(2.400)	50	1776472001	1838550000
14	66.04	(2.600)	50	1776482001	1838560000
15	71.12	(2.800)	50	1776492001	1838570000
16	76.20	(3.000)	50	1776502001	1838580000
17	81.28	(3.200)	20	1776512001	1838590000
18	86.36	(3.400)	20	1776522001	1838600000
19	91.44	(3.600)	20	1776532001	1838610000
20	96.52	(3.800)	20	1776542001	1838620000
21	101.60	(4.000)	20	1776552001	1838630000
22	106.68	(4.200)	20	1776572001	1838640000
23	111.76	(4.400)	20	1776582001	1838650000
24	116.84	(4.600)	20	1776592001	1838660000

Pitch 5.00 mm

Poles	L1 mm	(inch)	Qty.	Order No.	Order No.
2	5.00	(0.197)	100	1796780000	1841390000
3	10.00	(0.394)	100	1796790000	1841400000
4	15.00	(0.591)	100	1796800000	1841410000
5	20.00	(0.787)	50	1796810000	1841420000
6	25.00	(0.984)	50	1796820000	1841430000
7	30.00	(1.181)	50	1796830000	1841440000
8	35.00	(1.378)	50	1796840000	1841450000
9	40.00	(1.575)	50	1796850000	1841460000
10	45.00	(1.772)	50	1796860000	1841470000
11	50.00	(1.969)	50	1796870000	1841480000
12	55.00	(2.165)	50	1796880000	1841490000
13	60.00	(2.362)	50	1796890000	1841500000
14	65.00	(2.559)	50	1796900000	1841510000
15	70.00	(2.756)	50	1796910000	1841520000
16	75.00	(2.953)	50	1796920000	1841530000
17	80.00	(3.150)	20		1841540000
18	85.00	(3.346)	20		1841550000
19	90.00	(3.543)	20		1841560000
20	95.00	(3.740)	20		1841570000
21	100.00	(3.937)	20		1841580000
22	105.00	(4.134)	20		1841590000
23	110.00	(4.331)	20		1841600000
24	115.00	(4.528)	20		1841610000

Technical data

Rated data to IEC 60664-1 / IEC 61984

Clamping range, max.	mm ²		
Solid H05(07) V-U	mm ²		
Stranded H07 V-R	mm ²		
Flexible H05(07) V-K	mm ²		
Flexible with ferrule	mm ²		
Ferrule with plastic collar	mm ²		
Stripping length	mm		
Screwdriver blade	mm		
according to norm			
Tightening torque range	Nm		

Rated current

at ambient temperature	20°C	40°C
A	19	16

Overvoltage category

	III	III	II
Pollution severity	3	2	2

Rated voltage	V	250	320	400
Rated impulse voltage	kV	4	4	4

UL 1059 rated data - E60693

	B	C	D
Rated voltage	V	300	300
Rated current	A	15	10
AWG conductor			

CSA C22.2 rated data - LR12400 B

	B	C	D
Rated voltage	V	300	300
Rated current	A	15	10
AWG conductor			

Material data

Type of insulating material	LCP GF
Flammability class acc. UL94	V-0
Contact base material	CuSn
Material of contact surface	tinned

Information

- Additional colours on request
- Gold-plated contact surfaces on request
- Rated current related to rated cross-section and min. No. of poles.
- Hole diameter D = 1.4+0.1mm
- Hole diameter D = 1.5+0.1mm for 9 poles
- P on drg. = pitch
- Rated data refer only to the component itself. Clearance and creepage distances to other components are to be designed in accordance with the relevant application standards.

SL-SMT 5.08/180LF Tape
SL-SMT 5.00/180LF Tape

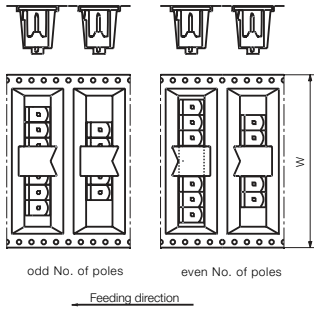

Accessories

Possible colors

Additional colours on request



Coding

See chapter accessories



Marking strips

See chapter accessories



Compartment partition element

See chapter accessories



Ordering data

Solder pin length	1.5 mm
Colour	black

Pitch 5.08 mm					
Poles	L1 mm	(inch)	Qty.	Order No.	Order No.
2	5.08	(0.200)	200	1776364001	
3	10.16	(0.400)	265	1776374001	
4	15.24	(0.600)	265	1776384001	
5	20.32	(0.800)	265	1776394001	
6	25.40	(1.000)	200	1776404001	

Pitch 5.00 mm					
Poles	L1 mm	(inch)	Qty.	Order No.	Order No.
2	5.00	(0.197)	200	1797930000	
3	10.00	(0.394)	200	1797940000	
4	15.00	(0.591)	200	1797950000	
5	20.00	(0.787)	200	1797960000	
6	25.00	(0.984)	200	1797970000	

Pitch 5.08 mm: tape width W = 56 mm
Pitch 5.00 mm: tape width W = 56 mm

Male connectors with THR solder connection

SL-SMT 5.08/270 GL

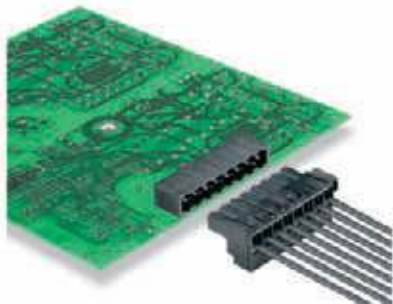

High-temperature-resistant, 270° angled, low, closed ended male connector. Packed in a box or tape on reel. In tape form with 1.5 mm solder pin optimised for automatic assembly; 3.2 mm solder pin suitable for reflow and wave soldering. Stable up to 290°C (2 x 30 s), which exceeds the requirements of EN 61760-1. These male connectors can be labelled and coded.

- 400 V (IEC) / 300 V (UL)
- 19 A (IEC) / 15 A (UL)

Derating curve

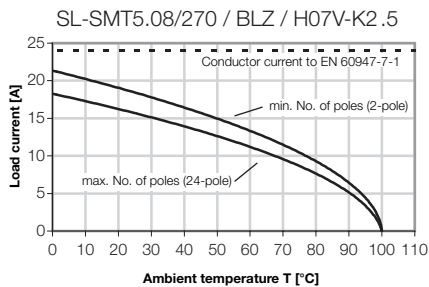

SL-SMT 5.08/270 GL Box

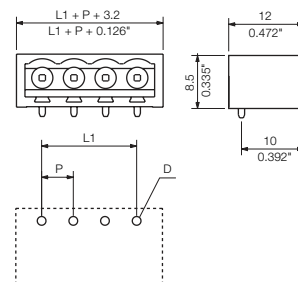

F

Technical data

Rated data to IEC 60664-1 / IEC 61984			
Clamping range, max.	mm ²		
Solid H05(07) V-U	mm ²		
Stranded H07 V-R	mm ²		
Flexible H05(07) V-K	mm ²		
Flexible with ferrule	mm ²		
Ferrule with plastic collar	mm ²		
Stripping length	mm		
Screwdriver blade	mm		
according to norm			
Tightening torque range	Nm		
Rated current at ambient temperature		20°C	40°C
	A	19	16
Overvoltage category		III	III
Pollution severity		3	2
Rated voltage	V	250	320
Rated impulse voltage	kV	4	4
UL 1059 rated data - E60693		B	C
Rated voltage	V	300	300
Rated current	A	15	10
AWG conductor			
CSA C22.2 rated data - LR12400 B		B	C
Rated voltage	V	300	300
Rated current	A	15	10
AWG conductor			
Material data			
Type of insulating material		LCP GF	
Flammability class acc. UL94		V-0	
Contact base material		CuSn	
Material of contact surface		tinned	
Information			

- Additional colours on request
- Gold-plated contact surfaces on request
- Rated current related to rated cross-section and min. No. of poles.
- Hole diameter D = 1.4+0.1mm
- Hole diameter D = 1.5+0.1mm for 9 poles
- P on drg. = pitch
- Rated data refer only to the component itself. Clearance and creepage distances to other components are to be designed in accordance with the relevant application standards.

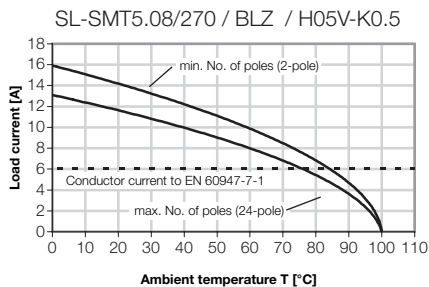

Ordering data

Solder pin length		1.5 mm	3.2 mm
Colour		black	black
Pitch 5.08 mm			
Poles	L1 mm (inch)	Qty.	Order No.
2	5.08 (0.200)	100	1877100000
3	10.16 (0.400)	100	1877130000
4	15.24 (0.600)	100	1877140000
5	20.32 (0.800)	50	1877150000
6	25.40 (1.000)	50	1877160000
7	30.48 (1.200)	50	1877170000
8	35.56 (1.400)	50	1877180000
			1877470000
			1877490000
			1877510000
			1877520000
			1877530000
			1877540000
			1877550000

SL-SMT 5.08/270 GL Tape

Accessories

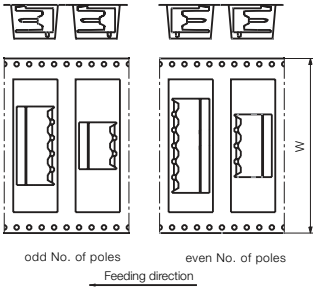

Possible colors

Additional colours on request



Coding

See chapter accessories



Marking strips

See chapter accessories



Compartment partition element

See chapter accessories



Ordering data

Solder pin length	1.5 mm	3.2 mm
Colour	black	black

Pitch 5.08 mm

Poles	L1 mm	(inch)	Qty.	Order No.	Order No.
2	5.08	(0.200)	200	1877740000	1877880000
3	10.16	(0.400)	200	1877750000	1877890000
4	15.24	(0.600)	200	1877760000	1877900000
5	20.32	(0.800)	200	1877770000	1877910000
6	25.40	(1.000)	200	1877780000	1877920000
7	30.48	(1.200)	200	1877790000	1877930000
8	35.56	(1.400)	200	1877800000	1877940000

Male connectors with THR solder connection

SL-SMT 5.08/270 GH



High-temperature-resistant, 270° angled, high, closed ended male connector. Packed in a box or tape on reel. In tape form with 1.5 mm solder pin optimised for automatic assembly; 3.2 mm solder pin suitable for reflow and wave soldering. Stable up to 290°C (2 x 30 s), which exceeds the requirements of EN 61760-1. These male connectors can be labelled and coded.

- 400 V (IEC) / 300 V (UL)
- 19 A (IEC) / 15 A (UL)

Derating curve

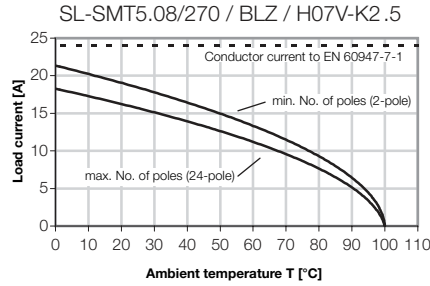

SL-SMT 5.08/270 GH Box

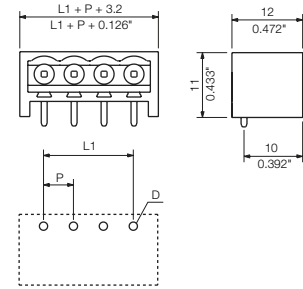

F

Technical data

Rated data to IEC 60664-1 / IEC 61984

Clamping range, max.	mm ²
Solid H05(07) V-U	mm ²
Stranded H07 V-R	mm ²
Flexible H05(07) V-K	mm ²
Flexible with ferrule	mm ²
Ferrule with plastic collar	mm ²
Stripping length	mm
Screwdriver blade	mm
according to norm	
Tightening torque range	Nm

Rated current

at ambient temperature	20°C	40°C
A	19	16

Overvoltage category

	III	III	II
Pollution severity	3	2	2

Rated voltage	V	250	320	400
Rated impulse voltage	kV	4	4	4

UL 1059 rated data - E60693

	B	C	D
Rated voltage	V	300	300
Rated current	A	15	10

CSA C22.2 rated data - LR12400 B

	B	C	D
Rated voltage	V	300	300
Rated current	A	15	10

Material data

Type of insulating material	LCP GF
Flammability class acc. UL94	V-0
Contact base material	CuSn
Material of contact surface	tinned

Information

- Additional colours on request
- Gold-plated contact surfaces on request
- Rated current related to rated cross-section and min. No. of poles.
- Hole diameter D = 1.4+0.1mm
- Hole diameter D = 1.5+0.1mm for 9 poles
- P on drg. = pitch
- Rated data refer only to the component itself. Clearance and creepage distances to other components are to be designed in accordance with the relevant application standards.

SL-SMT5.08/270 / BLZ / H05V-K0.5

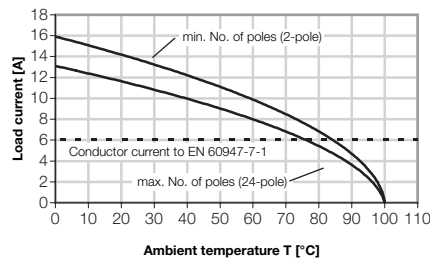

Ordering data

Solder pin length	1.5 mm	3.2 mm		
Colour	black	black		
Pitch 5.08 mm				
Poles	L1 mm (inch)	Qty.	Order No.	Order No.
2	5.08 (0.200)	100	1876340000	1877370000
3	10.16 (0.400)	100	1877010000	1877380000
4	15.24 (0.600)	100	1877030000	1877390000
5	20.32 (0.800)	50	1877040000	1877400000
6	25.40 (1.000)	50	1877050000	1877410000
7	30.48 (1.200)	50	1877060000	1877420000
8	35.56 (1.400)	50	1877080000	1877450000

SL-SMT 5.08/270 GH Tape

Accessories

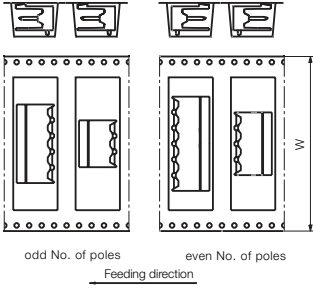

Possible colors

Additional colours on request



Coding

See chapter accessories



Marking strips

See chapter accessories



Compartment partition element

See chapter accessories



Ordering data

Solder pin length	1.5 mm	3.2 mm
Colour	black	black

Pitch 5.08 mm

Poles	L1 mm	(inch)	Qty.	Order No.	Order No.
2	5.08	(0.200)	150	1877560000	1877810000
3	10.16	(0.400)	150	1877600000	1877820000
4	15.24	(0.600)	150	1877610000	1877830000
5	20.32	(0.800)	150	1877620000	1877840000
6	25.40	(1.000)	150	1877630000	1877850000
7	30.48	(1.200)	150	1877640000	1877860000
8	35.56	(1.400)	150	1877650000	1877870000

Male connectors with THR solder connection

SL-SMT 5.08/270 FL



High-temperature-resistant, 270° angled, low male connector with solder flange. Packed in a box or in tape on reel. In tape form with 1.5 mm solder pin optimised for automatic assembly; 3.2 mm solder pin suitable for reflow and wave soldering. Stable up to 290°C (2 x 30 s), which exceeds the requirements of EN 61760-1. These male connectors can be labelled and coded.

- 400 V (IEC) / 300 V (UL)
- 19 A (IEC) / 15 A (UL)

Derating curve

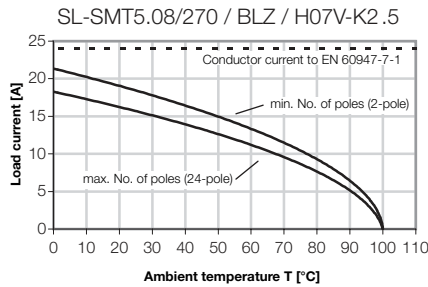

SL-SMT 5.08/270 FL Box

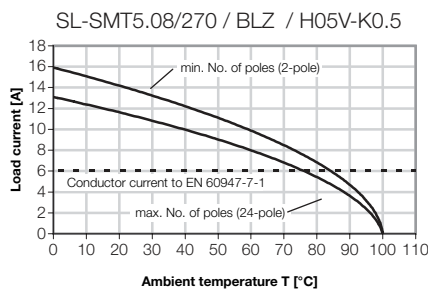
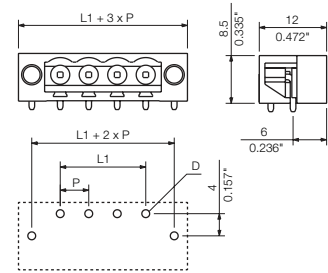

Ordering data

Solder pin length	1.5 mm	3.2 mm		
Colour	black	black		
Pitch 5.08 mm				
Poles	L1 mm (inch)	Qty.	Order No.	Order No.
2	5.08 (0.200)	100	1878090000	1876850000
3	10.16 (0.400)	100	1878110000	1876860000
4	15.24 (0.600)	100	1878120000	1876870000
5	20.32 (0.800)	50	1878130000	1876880000
6	25.40 (1.000)	50	1878140000	1876890000
7	30.48 (1.200)	50	1878150000	1876900000
8	35.56 (1.400)	50	1878160000	1876910000

F

Technical data

Rated data to IEC 60664-1 / IEC 61984			
Clamping range, max.	mm ²		
Solid H05(07) V-U	mm ²		
Stranded H07 V-R	mm ²		
Flexible H05(07) V-K	mm ²		
Flexible with ferrule	mm ²		
Ferrule with plastic collar	mm ²		
Stripping length	mm		
Screwdriver blade	mm		
according to norm			
Tightening torque range	Nm		
Rated current at ambient temperature		20°C	40°C
	A	19	16
Overvoltage category		III	III
Pollution severity		3	2
Rated voltage	V	250	320
Rated impulse voltage	kV	4	4
UL 1059 rated data - E60693		B	C
Rated voltage	V	300	300
Rated current	A	15	10
AWG conductor			
CSA C22.2 rated data - LR12400 B		B	C
Rated voltage	V	300	300
Rated current	A	15	10
AWG conductor			
Material data			
Type of insulating material		LCP GF	
Flammability class acc. UL94		V-0	
Contact base material		CuSn	
Material of contact surface		tinned	

- Information**
- Additional colours on request
 - Gold-plated contact surfaces on request
 - Rated current related to rated cross-section and min. No. of poles.
 - Hole diameter D = 1.4+0.1mm
 - Hole diameter D = 1.5+0.1mm for 9 poles
 - P on drg. = pitch
 - Rated data refer only to the component itself. Clearance and creepage distances to other components are to be designed in accordance with the relevant application standards.

SL-SMT 5.08/270 FL Tape

Accessories

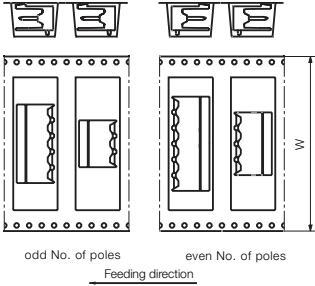

Possible colors

Additional colours on request



Coding

See chapter accessories



Marking strips

See chapter accessories



Compartment partition element

See chapter accessories



Ordering data

Solder pin length	1.5 mm	3.2 mm
Colour	black	black

Pitch 5.08 mm

Poles	L1 mm	(inch)	Qty.	Order No.	Order No.
2	5.08	(0.200)	200	1876990000	1876730000
3	10.16	(0.400)	200	1877000000	1876720000
4	15.24	(0.600)	200	1877020000	1876710000
5	20.32	(0.800)	200	1877070000	1876700000
6	25.40	(1.000)	200	1877090000	1876690000
7	30.48	(1.200)	200	1877110000	1876680000
8	35.56	(1.400)	200	1877120000	1876670000

Male connectors with THR solder connection

SL-SMT 5.08/270 FH



High-temperature-resistant, 270° angled, high level male connector with solder flange. Packed in a box or in tape on reel. In tape form with 1.5 mm solder pin optimised for automatic assembly; 3.2 mm solder pin suitable for reflow and wave soldering. Stable up to 290°C (2 x 30 s), which exceeds the requirements of EN 61760-1. These male connectors can be labelled and coded.

- 400 V (IEC) / 300 V (UL)
- 19 A (IEC) / 15 A (UL)

Derating curve

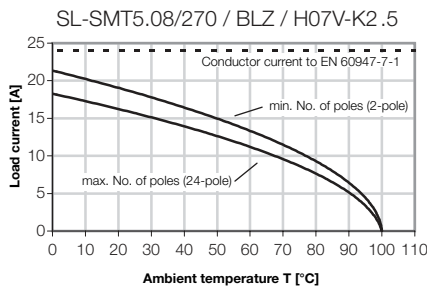

SL-SMT 5.08/270 FH Box

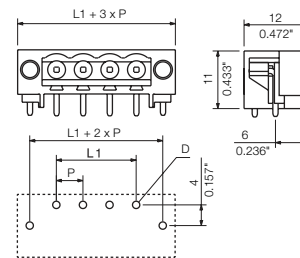

F

Technical data

Rated data to IEC 60664-1 / IEC 61984			
Clamping range, max.	mm ²		
Solid H05(07) V-U	mm ²		
Stranded H07 V-R	mm ²		
Flexible H05(07) V-K	mm ²		
Flexible with ferrule	mm ²		
Ferrule with plastic collar	mm ²		
Stripping length	mm		
Screwdriver blade	mm		
according to norm			
Tightening torque range	Nm		
Rated current at ambient temperature		20°C	40°C
	A	19	16
Overvoltage category		III	III
Pollution severity		3	2
Rated voltage	V	250	320
Rated impulse voltage	kV	4	4
UL 1059 rated data - E60693		B	C
Rated voltage	V	300	300
Rated current	A	15	10
AWG conductor			
CSA C22.2 rated data - LR12400 B		B	C
Rated voltage	V	300	300
Rated current	A	15	10
AWG conductor			
Material data			
Type of insulating material		LCP GF	
Flammability class acc. UL94		V-0	
Contact base material		CuSn	
Material of contact surface		tinned	
Information			

- Additional colours on request
- Gold-plated contact surfaces on request
- Rated current related to rated cross-section and min. No. of poles.
- Hole diameter D = 1.4+0.1mm
- Hole diameter D = 1.5+0.1mm for 9 poles
- P on drg. = pitch
- Rated data refer only to the component itself. Clearance and creepage distances to other components are to be designed in accordance with the relevant application standards.

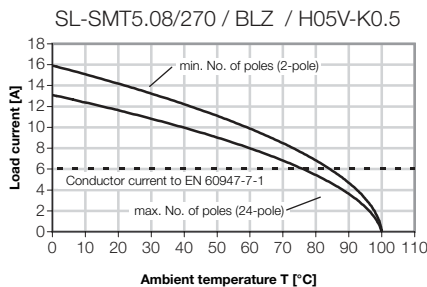

Ordering data

Solder pin length	1.5 mm	3.2 mm		
Colour	black	black		
Pitch 5.08 mm				
Poles	L1 mm (inch)	Qty.	Order No.	Order No.
2	5.08 (0.200)	100	1877960000	1877190000
3	10.16 (0.400)	100	1877970000	1877210000
4	15.24 (0.600)	100	1877980000	1877330000
5	20.32 (0.800)	50	1877990000	1877430000
6	25.40 (1.000)	50	1878000000	1877460000
7	30.48 (1.200)	50	1878010000	1877480000
8	35.56 (1.400)	50	1878020000	1877500000

SL-SMT 5.08/270 FH Tape

Accessories

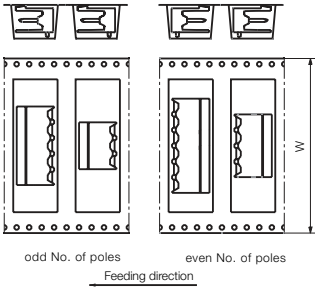

Possible colors

Additional colours on request



Coding

See chapter accessories



Marking strips

See chapter accessories



Compartment partition element

See chapter accessories



Ordering data

Solder pin length	1.5 mm	3.2 mm
Colour	black	black

Pitch 5.08 mm

Poles	L1 mm	(inch)	Qty.	Order No.	Order No.
2	5.08	(0.200)	150	1876920000	1876840000
3	10.16	(0.400)	150	1876930000	1876830000
4	15.24	(0.600)	150	1876940000	1876820000
5	20.32	(0.800)	150	1876950000	1876810000
6	25.40	(1.000)	150	1876960000	1876800000
7	30.48	(1.200)	150	1876970000	1876790000
8	35.56	(1.400)	150	1876980000	1876740000

SLDV-THR 5.00/180GLF Box

with solder flange

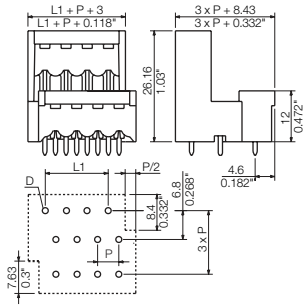

Ordering data

Solder pin length	1.5 mm	3.2 mm
Colour	black	black

Pitch 5.00 mm

Poles	L1 mm	(inch)	Qty.	Order No.	Order No.
4	5.00	(0.197)	50	1911750000	1911290000
6	10.00	(0.394)	50	1911760000	1911310000
8	15.00	(0.591)	50	1911770000	1911320000
10	20.00	(0.787)	50	1911780000	1911330000
12	25.00	(0.984)	50	1911790000	1911340000
14	30.00	(1.181)	20	1911800000	1911350000
16	35.00	(1.378)	20	1911810000	1911360000
18	40.00	(1.575)	20	1911820000	1911370000
20	45.00	(1.772)	20	1911830000	1911410000
22	50.00	(1.969)	10	1911840000	1911470000
24	55.00	(2.165)	10	1911850000	1911500000
26	60.00	(2.362)	10	1911860000	1911520000
28	65.00	(2.559)	10	1911870000	1911550000
30	70.00	(2.756)	10	1911880000	1911640000
32	75.00	(2.953)	10	1911890000	1911650000
34	80.00	(3.150)	10	1911900000	1911660000
36	85.00	(3.346)	10	1911910000	1911670000
38	90.00	(3.543)	10	1911920000	1911680000
40	95.00	(3.740)	10	1911930000	1911690000
42	100.00	(3.937)	10	1911940000	1911710000
44	105.00	(4.134)	10	1911950000	1911720000
46	110.00	(4.331)	10	1911960000	1911730000
48	115.00	(4.528)	10	1911970000	1911740000

Accessories

Possible colors

Additional colours on request



Coding

See chapter accessories



Marking strips

See chapter accessories



Compartment partition element

See chapter accessories



SLDV-THR 180GLF

The space-saving SLDVTHR double level male connector complements the reflow-compatible products from Weidmüller. High-temperature-resistant plastics enable the product to be integrated into the reflow soldering process.

This range offers additional fixing to the PCB to resist greater mechanical loads.

The SLDV-THR...GLF incorporates an additional fixing without screws to relieve the mechanical loads on the contact pins. To do this, there are solder pins in optimum positions which do not have an electrical function.

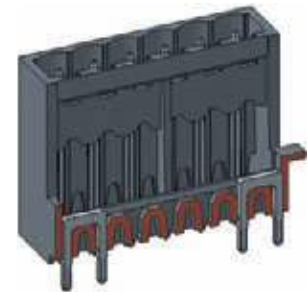

Male connectors with THR solder connection

SLDV-THR 5.08 SLDV-THR 5.00



High-temperature-resistant, double level, laterally offset male connector with flange or solder flange. 1.5 mm solder pin suitable for reflow soldering. 3.2 mm solder pin suitable for reflow and wave soldering. Stable up to 290°C (2 x 30 s), which exceeds the requirements of EN 61760-1. These male connectors can be labelled and coded. Packaged in cardboard box.

- 400 V (IEC) / 300 V (UL)
- 15 A (IEC) / 10 A (UL)

Derating curve

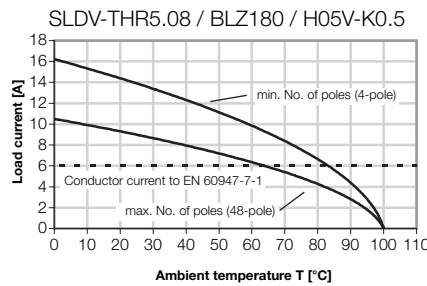
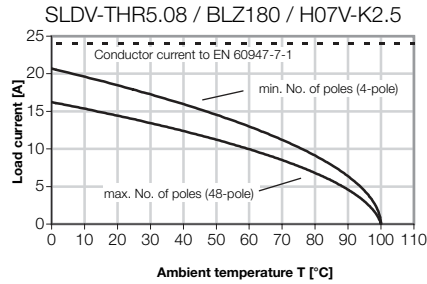

SLDV-THR 5.08/180F Box SLDV-THR 5.00/180F Box

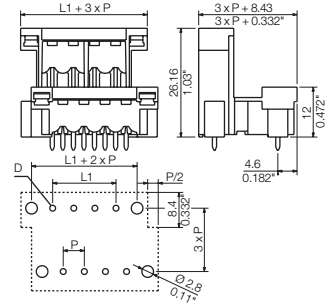

Ordering data

Solder pin length	1.5 mm	3.2 mm
Colour	black	black

Pitch 5.08 mm					
Poles	L1 mm	(inch)	Qty.	Order No.	Order No.
4	5.08	(0.200)	50	1828890000	1828770000
6	10.16	(0.400)	50	1828900000	1828780000
8	15.24	(0.600)	50	1828910000	1828790000
10	20.32	(0.800)	50	1828920000	1828800000
12	25.40	(1.000)	50	1828930000	1828810000
14	30.48	(1.200)	20	1828940000	1828820000
16	35.56	(1.400)	20	1828950000	1828830000
18	40.64	(1.600)	20	1828960000	1828840000
20	45.72	(1.800)	20	1828970000	1828850000
22	50.80	(2.000)	10	1828980000	1828860000
24	55.88	(2.200)	10	1828990000	1828870000
26	60.96	(2.400)	10	1829000000	1828880000
28	66.04	(2.600)	10	1881310000	1889340000
30	71.12	(2.800)	10	1881320000	1889350000
32	76.20	(3.000)	10	1881330000	1866330000
34	81.28	(3.200)	10	1881350000	1889360000
36	86.36	(3.400)	10	1881360000	1889370000
38	91.44	(3.600)	10	1881380000	1889380000
40	96.52	(3.800)	10	1881410000	1889390000
42	101.60	(4.000)	10	1881430000	1889400000
44	106.68	(4.200)	10	1881440000	1889410000
46	111.76	(4.400)	10	1881450000	1889420000
48	116.84	(4.600)	10	1881460000	1889430000

Pitch 5.00 mm					
Poles	L1 mm	(inch)	Qty.	Order No.	Order No.
4	5.00	(0.197)	50	1895230000	1882930000
6	10.00	(0.394)	50	1895240000	1882940000
8	15.00	(0.591)	50	1895250000	1882950000
10	20.00	(0.787)	50	1895260000	1882960000
12	25.00	(0.984)	50	1895270000	1882970000
14	30.00	(1.181)	20	1895280000	1882980000
16	35.00	(1.378)	20	1895290000	1882990000
18	40.00	(1.575)	20	1895300000	1883000000
20	45.00	(1.772)	20	1895310000	1883010000
22	50.00	(1.969)	10	1895320000	1883020000
24	55.00	(2.165)	10	1895330000	1883030000
26	60.00	(2.362)	10	1895340000	1883040000
28	65.00	(2.559)	10	1895350000	1883050000
30	70.00	(2.756)	10	1895360000	1883060000
32	75.00	(2.953)	10	1895370000	1883070000
34	80.00	(3.150)	10	1895380000	1883080000
36	85.00	(3.346)	10	1895390000	1883090000
38	90.00	(3.543)	10	1895400000	1883100000
40	95.00	(3.740)	10	1895410000	1883110000
42	100.00	(3.937)	10	1895420000	1883120000
44	105.00	(4.134)	10	1895430000	1883130000
46	110.00	(4.331)	10	1895440000	1883140000
48	115.00	(4.528)	10	1895450000	1883150000

Technical data

Rated data to IEC 60664-1 / IEC 61984				
Clamping range, max.	mm ²			
Solid H05(07) V-U	mm ²			
Stranded H07 V-R	mm ²			
Flexible H05(07) V-K	mm ²			
Flexible with ferrule	mm ²			
Ferrule with plastic collar	mm ²			
Stripping length	mm			
Screwdriver blade	mm			
according to norm				
Tightening torque range	Nm			
Rated current at ambient temperature				
	A	20°C	40°C	
		15	13	
Overvoltage category				
		III	III	II
Pollution severity				
		3	2	2
Rated voltage	V	250	320	400
Rated impulse voltage	kV	4	4	4
UL 1059 rated data - E60693				
		B	C	D
Rated voltage	V	300	300	300
Rated current	A	10	10	10
AWG conductor				
CSA C22.2 rated data - LR12400 B				
		B	C	D
Rated voltage	V	300	300	300
Rated current	A	10	10	10
AWG conductor				
Material data				
Type of insulating material		LCP GF		
Flammability class acc. UL94		V-0		
Contact base material		CuSn		
Material of contact surface		tinned		

- Information**
- Additional colours on request
 - Rated current related to rated cross-section and min. No. of poles.
 - Spacing between rows: see hole layout
 - Hole diameter D = 1.4+0.1mm
 - Hole diameter D = 1.5+0.1mm for 18 poles
 - P on drg. = pitch
 - Rated data refer only to the component itself. Clearance and creepage distances to other components are to be designed in accordance with the relevant application standards.

SLDV-THR 5.08/180FLF Box
SLDV-THR 5.00/180FLF Box

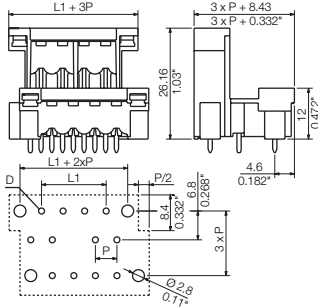

Ordering data

Solder pin length	1.5 mm	3.2 mm
Colour	black	black

Pitch 5.08 mm

Poles	L1 mm	(inch)	Qty.	Order No.	Order No.
4	5.08	(0.200)	50	1829130000	1829010000
6	10.16	(0.400)	50	1829140000	1829020000
8	15.24	(0.600)	50	1829150000	1829030000
10	20.32	(0.800)	50	1829160000	1829040000
12	25.40	(1.000)	50	1829170000	1829050000
14	30.48	(1.200)	20	1829180000	1829060000
16	35.56	(1.400)	20	1829190000	1829070000
18	40.64	(1.600)	20	1829200000	1829080000
20	45.72	(1.800)	20	1829210000	1829090000
22	50.80	(2.000)	10	1829220000	1829100000
24	55.88	(2.200)	10	1829230000	1829110000
26	60.96	(2.400)	10	1829240000	1829120000
28	66.04	(2.600)	10	1881480000	1889200000
30	71.12	(2.800)	10	1881500000	1889210000
32	76.20	(3.000)	10	1881510000	1866320000
34	81.28	(3.200)	10	1881520000	1889220000
36	86.36	(3.400)	10	1881530000	1889270000
38	91.44	(3.600)	10	1881540000	1889280000
40	96.52	(3.800)	10	1881550000	1889290000
42	101.60	(4.000)	10	1881560000	1889300000
44	106.68	(4.200)	10	1881570000	1889310000
46	111.76	(4.400)	10	1881580000	1889320000
48	116.84	(4.600)	10	1881590000	1889330000

Pitch 5.00 mm

Poles	L1 mm	(inch)	Qty.	Order No.	Order No.
4	5.00	(0.197)	50	1895460000	1883100000
6	10.00	(0.394)	50	1895470000	1883110000
8	15.00	(0.591)	50	1895480000	1883120000
10	20.00	(0.787)	50	1895490000	1883130000
12	25.00	(0.984)	50	1895500000	1883140000
14	30.00	(1.181)	20	1895510000	1883150000
16	35.00	(1.378)	20	1895520000	1883160000
18	40.00	(1.575)	20	1895530000	1883170000
20	45.00	(1.772)	20	1895540000	1883180000
22	50.00	(1.969)	10	1895550000	1883190000
24	55.00	(2.165)	10	1895560000	1883200000
26	60.00	(2.362)	10	1895570000	1883230000
28	65.00	(2.559)	10	1895580000	1883240000
30	70.00	(2.756)	10	1895590000	1883250000
32	75.00	(2.953)	10	1895600000	1883270000
34	80.00	(3.150)	10	1895610000	1883280000
36	85.00	(3.346)	10	1895620000	1883290000
38	90.00	(3.543)	10	1895630000	1883300000
40	95.00	(3.740)	10	1895640000	1883310000
42	100.00	(3.937)	10	1895650000	1883320000
44	105.00	(4.134)	10	1895660000	1883330000
46	110.00	(4.331)	10	1895670000	1883340000
48	115.00	(4.528)	10	1895680000	1883350000

Accessories

Possible colors

Additional colours on request



Coding

See chapter accessories



Marking strips

See chapter accessories



Compartment partition element

See chapter accessories



SLDV-THR 180F
SLDV-THR 180FLF

The space-saving SLDVTHR double level male connector complements the reflow-compatible products from Weidmüller. High-temperature-resistant plastics enable the product to be integrated into the reflow soldering process.

This range offers additional fixing to the PCB to resist greater mechanical loads.

1. With screw flanges for additional mechanical fixing to the PCB (see SLDV-THR.../.../..F).

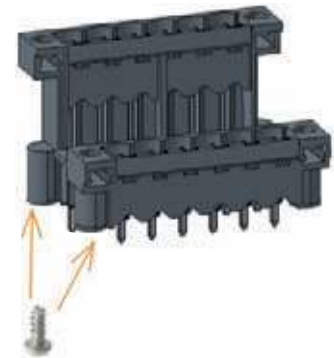

2. With solder flange for fixing to the PCB without screws. Additional solder pins in optimum positions which do not have an electrical function, relieve the mechanical loads on the contact pins. In some applications it is no longer necessary to screw the male connector to the PCB (see SLDV-THR.../.../..FLF).

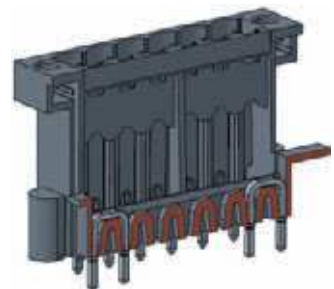

Male connectors with solder connection

SL 5.08/90
SL 5.00/90

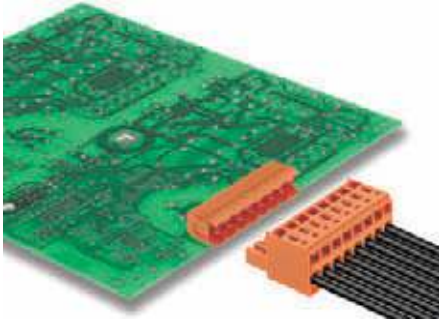

Male connectors with 90° outlet direction. The solder pin length is optimised for wave flow soldering process. The male connectors provide space for labelling and can be coded. Packed in cardboard box.

- 400 V (IEC) / 300 V (UL)
- 18 A (IEC) / 15 A (UL)

Derating curve

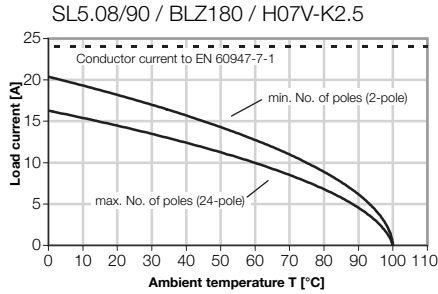

SL 5.08/90
SL 5.00/90

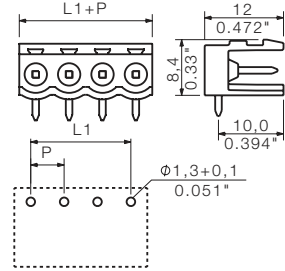

F

Technical data

Rated data to IEC 60664-1 / IEC 61984

Clamping range, max.	mm ²
Solid H05(07) V-U	mm ²
Stranded H07 V-R	mm ²
Flexible H05(07) V-K	mm ²
Flexible with ferrule	mm ²
Ferrule with plastic collar	mm ²
Stripping length	mm
Screwdriver blade	mm
according to norm	
Tightening torque range	Nm

Rated current at ambient temperature		20°C	40°C
	A	18	15

Overvoltage category	III	III	II
Pollution severity	3	2	2

Rated voltage	V	250	320	400
Rated impulse voltage	kV	4	4	4

UL 1059 rated data - E60693			
	B	C	D
Rated voltage	V	300	300
Rated current	A	15	10
AWG conductor			

CSA C22.2 rated data - LR12400 B			
	B	C	D
Rated voltage	V	300	300
Rated current	A	15	10
AWG conductor			

Material data		PBT
Type of insulating material		V-0
Flammability class acc. UL94		CuSn
Contact base material		tinned
Material of contact surface		

- #### Information
- Additional colours on request
 - Gold-plated contact surfaces on request
 - Rated current related to rated cross-section and min. No. of poles.
 - P on drg. = pitch
 - Rated data refer only to the component itself. Clearance and creepage distances to other components are to be designed in accordance with the relevant application standards.

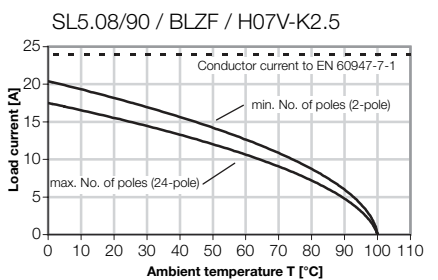
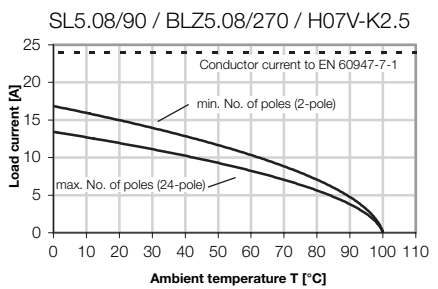
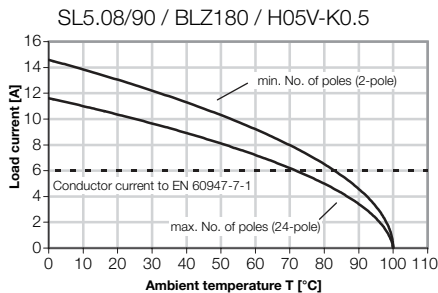

Ordering data

Solder pin length	3.2 mm
Colour	orange

Pitch 5.08 mm				
Poles	L1 mm	(inch)	Qty.	Order No.
2	5.08	(0.200)	100	1508060000
3	10.16	(0.400)	100	1508160000
4	15.24	(0.600)	100	1508260000
5	20.32	(0.800)	50	1508360000
6	25.40	(1.000)	50	1508460000
7	30.48	(1.200)	50	1508560000
8	35.56	(1.400)	50	1508660000
9	40.64	(1.600)	50	1508760000
10	45.72	(1.800)	50	1508860000
11	50.80	(2.000)	50	1508960000
12	55.88	(2.200)	50	1509060000
13	60.96	(2.400)	50	1509160000
14	66.04	(2.600)	50	1509260000
15	71.12	(2.800)	50	1509360000
16	76.20	(3.000)	50	1509460000
17	81.28	(3.200)	20	1509560000
18	86.36	(3.400)	20	1509660000
19	91.44	(3.600)	20	1509760000
20	96.52	(3.800)	20	1509860000
21	101.60	(4.000)	20	1509960000
22	106.68	(4.200)	20	1510060000
23	111.76	(4.400)	20	1510160000
24	116.84	(4.600)	20	1510260000

Pitch 5.00 mm				
Poles	L1 mm	(inch)	Qty.	Order No.
2	5.00	(0.197)	100	1571130000
3	10.00	(0.394)	100	1571140000
4	15.00	(0.591)	100	1571150000
5	20.00	(0.787)	50	1571160000
6	25.00	(0.984)	50	1571170000
7	30.00	(1.181)	50	1571180000
8	35.00	(1.378)	50	1571190000
9	40.00	(1.575)	50	1571200000
10	45.00	(1.772)	50	1571210000
11	50.00	(1.969)	50	1571220000
12	55.00	(2.165)	50	1571110000
13	60.00	(2.362)	50	1571230000
14	65.00	(2.559)	50	1571240000
15	70.00	(2.756)	50	1571250000
16	75.00	(2.953)	50	1571260000
17	80.00	(3.150)	20	1571270000
18	85.00	(3.346)	20	1571280000
19	90.00	(3.543)	20	1571290000
20	95.00	(3.740)	20	1571300000
21	100.00	(3.937)	20	1571310000
22	105.00	(4.134)	20	1571320000
23	110.00	(4.331)	20	1571330000
24	115.00	(4.528)	20	1571340000

SL 5.08/90B
SL 5.00/90B

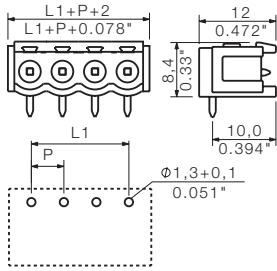

Accessories

Possible colors

Additional colours on request



Coding

See chapter accessories

Ordering data

Solder pin length	3.2 mm
Colour	orange

Pitch 5.08 mm

Poles	L1 mm	(inch)	Qty.	Order No.	Order No.
2	5.08	(0.200)	100		1510360000
3	10.16	(0.400)	100		1510460000
4	15.24	(0.600)	100		1510560000
5	20.32	(0.800)	50		1510660000
6	25.40	(1.000)	50		1510760000
7	30.48	(1.200)	50		1510860000
8	35.56	(1.400)	50		1510960000
9	40.64	(1.600)	50		1511060000
10	45.72	(1.800)	50		1511160000
11	50.80	(2.000)	50		1511260000
12	55.88	(2.200)	50		1511360000
13	60.96	(2.400)	50		1511460000
14	66.04	(2.600)	50		1511560000
15	71.12	(2.800)	50		1511660000
16	76.20	(3.000)	50		1511760000
17	81.28	(3.200)	20		1511860000
18	86.36	(3.400)	20		1511960000
19	91.44	(3.600)	20		1512060000
20	96.52	(3.800)	20		1512160000
21	101.60	(4.000)	20		1512260000
22	106.68	(4.200)	20		1512360000
23	111.76	(4.400)	20		1512460000
24	116.84	(4.600)	20		1512560000

Pitch 5.00 mm

Poles	L1 mm	(inch)	Qty.	Order No.	Order No.
2	5.00	(0.197)	100		1580860000
3	10.00	(0.394)	100		1580870000
4	15.00	(0.591)	100		1580880000
5	20.00	(0.787)	50		1580890000
6	25.00	(0.984)	50		1580900000
7	30.00	(1.181)	50		1580910000
8	35.00	(1.378)	50		1580920000
9	40.00	(1.575)	50		1580930000
10	45.00	(1.772)	50		1580940000
11	50.00	(1.969)	50		1580950000
12	55.00	(2.165)	50		1580960000
13	60.00	(2.362)	50		1580970000
14	65.00	(2.559)	50		1580980000
15	70.00	(2.756)	50		1580990000
16	75.00	(2.953)	50		1581000000
17	80.00	(3.150)	20		1581010000
18	85.00	(3.346)	20		1581020000
19	90.00	(3.543)	20		1581030000
20	95.00	(3.740)	20		1581040000
21	100.00	(3.937)	20		1581050000
22	105.00	(4.134)	20		1581060000
23	110.00	(4.331)	20		1581070000
24	115.00	(4.528)	20		1581080000



Fixing block

See chapter accessories



Marking strips

See chapter accessories



Floodlight indicator

See chapter accessories



Male connectors with solder connection

SL 5.08/180
SL 5.00/180

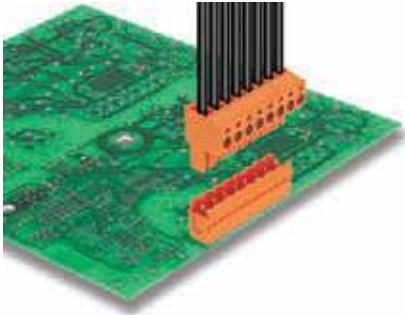

Male connectors, open or closed ended version, with straight 180° outlet direction, for PCB Mounting. The solder pin length is optimised for wave soldering. The male connectors provide space for labelling and can be coded. Packed in cardboard box.

- 400 V (IEC) / 300 V (UL)
- 18 A (IEC) / 15 A (UL)

Derating curve

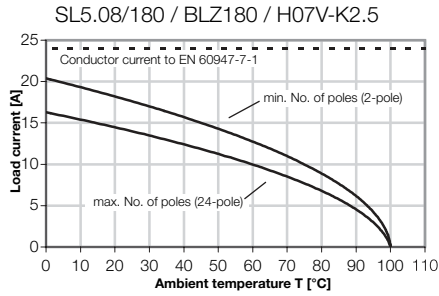

SL 5.08/180
SL 5.00/180

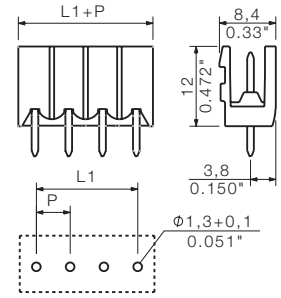

F

Technical data

Rated data to IEC 60664-1 / IEC 61984

Clamping range, max.	mm ²
Solid H05(07) V-U	mm ²
Stranded H07 V-R	mm ²
Flexible H05(07) V-K	mm ²
Flexible with ferrule	mm ²
Ferrule with plastic collar	mm ²
Stripping length	mm
Screwdriver blade	mm
according to norm	
Tightening torque range	Nm

Rated current

at ambient temperature	20°C	40°C
A	18	15

Overvoltage category

III	III	II
-----	-----	----

Pollution severity

3	2	2
---	---	---

Rated voltage	V	250	320	400
Rated impulse voltage	kV	4	4	4

UL 1059 rated data - E60693

	B	C	D
--	---	---	---

Rated voltage	V	300	300
Rated current	A	15	10

CSA C22.2 rated data - LR12400

	B	C	D
--	---	---	---

Rated voltage	V	300	300
Rated current	A	15	10

Material data

Type of insulating material	PBT
Flammability class acc. UL94	V-0
Contact base material	CuSn
Material of contact surface	tinned

Information

- Additional colours on request
- Gold-plated contact surfaces on request
- Rated current related to rated cross-section and min. No. of poles.
- P on drg. = pitch
- Rated data refer only to the component itself. Clearance and creepage distances to other components are to be designed in accordance with the relevant application standards.

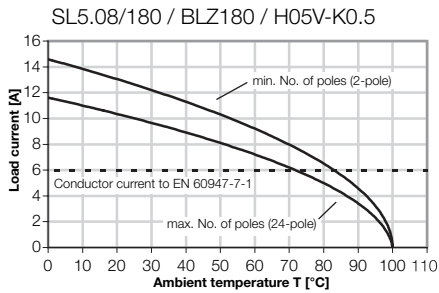

Ordering data

Solder pin length	3.2 mm
Colour	orange

Pitch 5.08 mm

Poles	L1 mm	(inch)	Qty.	Order No.	Order No.
2	5.08	(0.200)	100		1517260000
3	10.16	(0.400)	100		1517360000
4	15.24	(0.600)	100		1517460000
5	20.32	(0.800)	50		1517560000
6	25.40	(1.000)	50		1517660000
7	30.48	(1.200)	50		1517760000
8	35.56	(1.400)	50		1517860000
9	40.64	(1.600)	50		1517960000
10	45.72	(1.800)	50		1518060000
11	50.80	(2.000)	50		1518160000
12	55.88	(2.200)	50		1518260000
13	60.96	(2.400)	50		1518360000
14	66.04	(2.600)	50		1518460000
15	71.12	(2.800)	50		1518560000
16	76.20	(3.000)	50		1518660000
17	81.28	(3.200)	20		1518760000
18	86.36	(3.400)	20		1518860000
19	91.44	(3.600)	20		1518960000
20	96.52	(3.800)	20		1519060000
21	101.60	(4.000)	20		1519160000
22	106.68	(4.200)	20		1519260000
23	111.76	(4.400)	20		1519360000
24	116.84	(4.600)	20		1519460000

Pitch 5.00 mm

Poles	L1 mm	(inch)	Qty.	Order No.	Order No.
2	5.00	(0.197)	100		1581320000
3	10.00	(0.394)	100		1581330000
4	15.00	(0.591)	100		1581340000
5	20.00	(0.787)	50		1581350000
6	25.00	(0.984)	50		1581360000
7	30.00	(1.181)	50		1581370000
8	35.00	(1.378)	50		1581380000
9	40.00	(1.575)	50		1581390000
10	45.00	(1.772)	50		1581400000
11	50.00	(1.969)	50		1581410000
12	55.00	(2.165)	50		1581420000
13	60.00	(2.362)	50		1581430000
14	65.00	(2.559)	50		1581440000
15	70.00	(2.756)	50		1581450000
16	75.00	(2.953)	50		1581460000
17	80.00	(3.150)	20		1581470000
18	85.00	(3.346)	20		1581480000
19	90.00	(3.543)	20		1581490000
20	95.00	(3.740)	20		1581500000
21	100.00	(3.937)	20		1581510000
22	105.00	(4.134)	20		1581520000
23	110.00	(4.331)	20		1581530000
24	115.00	(4.528)	20		1581540000

SL 5.08/180B
SL 5.00/180B

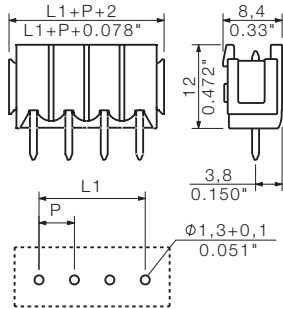

Accessories

Possible colors

Additional colours on request



Coding

See chapter accessories

Ordering data

Solder pin length	3.2 mm
Colour	orange

Pitch 5.08 mm

Poles	L1 mm	(inch)	Qty.	Order No.	Order No.
2	5.08	(0.200)	100		1519560000
3	10.16	(0.400)	100		1519660000
4	15.24	(0.600)	100		1519760000
5	20.32	(0.800)	50		1519860000
6	25.40	(1.000)	50		1519960000
7	30.48	(1.200)	50		1520060000
8	35.56	(1.400)	50		1520160000
9	40.64	(1.600)	50		1520260000
10	45.72	(1.800)	50		1520360000
11	50.80	(2.000)	50		1520460000
12	55.88	(2.200)	50		1520560000
13	60.96	(2.400)	50		1520660000
14	66.04	(2.600)	50		1520760000
15	71.12	(2.800)	50		1520860000
16	76.20	(3.000)	50		1520960000
17	81.28	(3.200)	20		1521060000
18	86.36	(3.400)	20		1521160000
19	91.44	(3.600)	20		1521260000
20	96.52	(3.800)	20		1521360000
21	101.60	(4.000)	20		1521460000
22	106.68	(4.200)	20		1521560000
23	111.76	(4.400)	20		1521660000
24	116.84	(4.600)	20		1521760000

Pitch 5.00 mm

Poles	L1 mm	(inch)	Qty.	Order No.	Order No.
2	5.00	(0.197)	100		1581780000
3	10.00	(0.394)	100		1581790000
4	15.00	(0.591)	100		1581800000
5	20.00	(0.787)	50		1581810000
6	25.00	(0.984)	50		1581820000
7	30.00	(1.181)	50		1581830000
8	35.00	(1.378)	50		1581840000
9	40.00	(1.575)	50		1581850000
10	45.00	(1.772)	50		1581860000
11	50.00	(1.969)	50		1581870000
12	55.00	(2.165)	50		1581880000
13	60.00	(2.362)	50		1581890000
14	65.00	(2.559)	50		1581900000
15	70.00	(2.756)	50		1581910000
16	75.00	(2.953)	50		1581920000
17	80.00	(3.150)	20		1581930000
18	85.00	(3.346)	20		1581940000
19	90.00	(3.543)	20		1581950000
20	95.00	(3.740)	20		1581960000
21	100.00	(3.937)	20		1581970000
22	105.00	(4.134)	20		1581980000
23	110.00	(4.331)	20		1581990000
24	115.00	(4.528)	20		1582000000



Fixing block

See chapter accessories



Marking strips

See chapter accessories



Male connectors with solder connection

SL 5.08/135
SL 5.00/135



Male connectors with 135° outlet direction. The solder pin length is optimised for wave soldering. The male connectors provide space for labelling and can be coded. Packed in cardboard box.

- 400 V (IEC) / 300 V (UL)
- 17 A (IEC) / 15 A (UL)

Derating curve

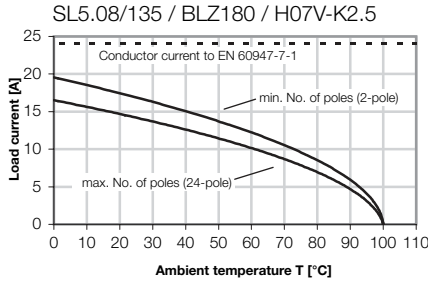

SL 5.08/135
SL 5.00/135

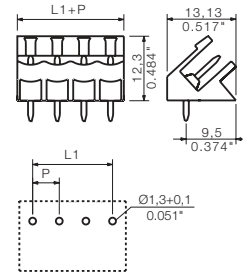

F

Technical data

Rated data to IEC 60664-1 / IEC 61984

Clamping range, max.	mm ²
Solid H05(07) V-U	mm ²
Stranded H07 V-R	mm ²
Flexible H05(07) V-K	mm ²
Flexible with ferrule	mm ²
Ferrule with plastic collar	mm ²
Stripping length	mm
Screwdriver blade	mm
according to norm	
Tightening torque range	Nm

Rated current at ambient temperature

	20°C	40°C
A	17	15

Overvoltage category

	III	III	II
Pollution severity	3	2	2

Pollution severity

	3	2	2
--	---	---	---

Rated voltage	V	250	320	400
Rated impulse voltage	kV	4	4	4

UL 1059 rated data - E60693

	B	C	D
--	---	---	---

Rated voltage	V	300	300
Rated current	A	15	10
AWG conductor			

CSA C22.2 rated data - LR12400 B

	B	C	D
--	---	---	---

Rated voltage	V	300	300
Rated current	A	15	10
AWG conductor			

Material data

Type of insulating material	PBT
Flammability class acc. UL94	V-0
Contact base material	CuSn
Material of contact surface	tinned

Information

- Additional colours on request
- Gold-plated contact surfaces on request
- Rated current related to rated cross-section and min. No. of poles.
- P on drg. = pitch
- Rated data refer only to the component itself. Clearance and creepage distances to other components are to be designed in accordance with the relevant application standards.

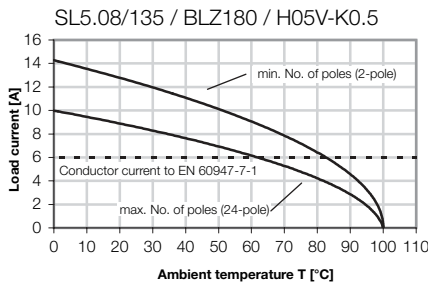

Ordering data

Solder pin length	3.2 mm
Colour	orange

Pitch 5.08 mm

Poles	L1 mm	(inch)	Qty.	Order No.	Order No.
2	5.08	(0.200)	100		1603060000
3	10.16	(0.400)	100		1603070000
4	15.24	(0.600)	100		1603080000
5	20.32	(0.800)	50		1603090000
6	25.40	(1.000)	50		1603100000
7	30.48	(1.200)	50		1603110000
8	35.56	(1.400)	50		1603120000
9	40.64	(1.600)	50		1603130000
10	45.72	(1.800)	50		1603140000
11	50.80	(2.000)	50		1603150000
12	55.88	(2.200)	50		1603160000
13	60.96	(2.400)	50		1603170000
14	66.04	(2.600)	50		1603180000
15	71.12	(2.800)	50		1603190000
16	76.20	(3.000)	50		1603200000
17	81.28	(3.200)	20		1603210000
18	86.36	(3.400)	20		1603220000
19	91.44	(3.600)	20		1603230000
20	96.52	(3.800)	20		1603240000
21	101.60	(4.000)	20		1603250000
22	106.68	(4.200)	20		1603260000
23	111.76	(4.400)	20		1603270000
24	116.84	(4.600)	20		1603280000

Pitch 5.00 mm

Poles	L1 mm	(inch)	Qty.	Order No.	Order No.
2	5.00	(0.197)	100		1603250000
3	10.00	(0.394)	100		1603260000
4	15.00	(0.591)	100		1603270000
5	20.00	(0.787)	50		1603280000
6	25.00	(0.984)	50		1603290000
7	30.00	(1.181)	50		1603300000
8	35.00	(1.378)	50		1603310000
9	40.00	(1.575)	50		1603320000
10	45.00	(1.772)	50		1603330000
11	50.00	(1.969)	50		1603340000
12	55.00	(2.165)	50		1603350000
13	60.00	(2.362)	50		1603360000
14	65.00	(2.559)	50		1603370000
15	70.00	(2.756)	50		1603380000
16	75.00	(2.953)	50		1603390000
17	80.00	(3.150)	20		1603400000
18	85.00	(3.346)	20		1603410000
19	90.00	(3.543)	20		1603420000
20	95.00	(3.740)	20		1603430000
21	100.00	(3.937)	20		1603440000
22	105.00	(4.134)	20		1603450000
23	110.00	(4.331)	20		1603460000
24	115.00	(4.528)	20		1603470000

SL 5.08/135B
SL 5.00/135B

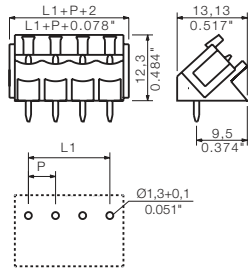

Accessories

Possible colors

Additional colours on request



Coding

See chapter accessories

Ordering data

Solder pin length	3.2 mm
Colour	orange

Pitch 5.08 mm

Poles	L1 mm	(inch)	Qty.	Order No.	Order No.
2	5.08	(0.200)	100		1605530000
3	10.16	(0.400)	100		1605540000
4	15.24	(0.600)	100		1605550000
5	20.32	(0.800)	50		1605560000
6	25.40	(1.000)	50		1605570000
7	30.48	(1.200)	50		1605580000
8	35.56	(1.400)	50		1605590000
9	40.64	(1.600)	50		1605600000
10	45.72	(1.800)	50		1605610000
11	50.80	(2.000)	50		1605620000
12	55.88	(2.200)	50		1605630000
13	60.96	(2.400)	50		1605640000
14	66.04	(2.600)	50		1605650000
15	71.12	(2.800)	50		1605660000
16	76.20	(3.000)	50		1605670000
17	81.28	(3.200)	20		1605680000
18	86.36	(3.400)	20		1605690000
19	91.44	(3.600)	20		1605700000
20	96.52	(3.800)	20		1605710000
21	101.60	(4.000)	20		1605720000
22	106.68	(4.200)	20		1605730000
23	111.76	(4.400)	20		1605740000
24	116.84	(4.600)	20		1605750000

Pitch 5.00 mm

Poles	L1 mm	(inch)	Qty.	Order No.	Order No.
2	5.00	(0.197)	100		1630480000
3	10.00	(0.394)	100		1630490000
4	15.00	(0.591)	100		1630500000
5	20.00	(0.787)	50		1630510000
6	25.00	(0.984)	50		1630520000
7	30.00	(1.181)	50		1630530000
8	35.00	(1.378)	50		1630540000
9	40.00	(1.575)	50		1630550000
10	45.00	(1.772)	50		1630560000
11	50.00	(1.969)	50		1630570000
12	55.00	(2.165)	50		1630580000
13	60.00	(2.362)	50		1630590000
14	65.00	(2.559)	50		1630600000
15	70.00	(2.756)	50		1630610000
16	75.00	(2.953)	50		1630620000
17	80.00	(3.150)	20		1630630000
18	85.00	(3.346)	20		1630640000
19	90.00	(3.543)	20		1630650000
20	95.00	(3.740)	20		1630660000
21	100.00	(3.937)	20		1630670000
22	105.00	(4.134)	20		1630680000
23	110.00	(4.331)	20		1630690000
24	115.00	(4.528)	20		1630700000



Fixing block

See chapter accessories



Marking strips

See chapter accessories



Male connectors with solder connection

SLD 5.08V

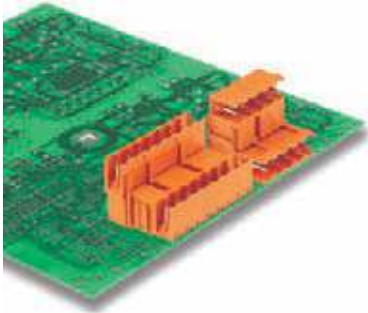

Double level, open ended, offset male connector with 90° outlet direction. The solder pin length has been optimised for wave soldering. These male connectors provide space for labelling and can be coded. Supplied in cardboard box.

- 400 V (IEC) / 300 V (UL)
- 17 A (IEC) / 10 A (UL)

Derating curve

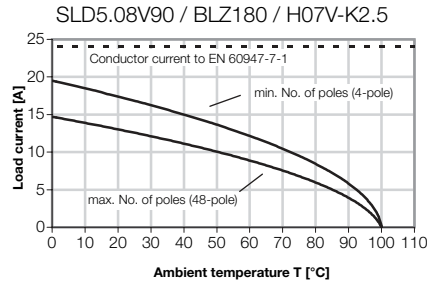

SLD 5.08V/90

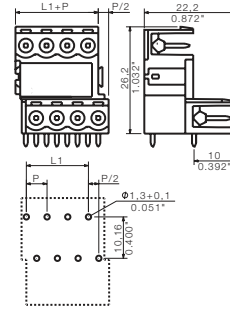

F

Technical data

Rated data to IEC 60664-1 / IEC 61984

Clamping range, max.	mm ²
Solid H05(07) V-U	mm ²
Stranded H07 V-R	mm ²
Flexible H05(07) V-K	mm ²
Flexible with ferrule	mm ²
Ferrule with plastic collar	mm ²
Stripping length	mm
Screwdriver blade	mm
according to norm	
Tightening torque range	Nm

Rated current

at ambient temperature		20°C	40°C
	A	17	15

Overvoltage category

	III	III	II
--	-----	-----	----

Pollution severity

	3	2	2
--	---	---	---

Rated voltage	V	250	320	400
Rated impulse voltage	kV	4	4	4

UL 1059 rated data - E60693

	B	C	D
--	---	---	---

Rated voltage	V	300	300
Rated current	A	10	10

CSA C22.2 rated data - LR12400 B

	B	C	D
--	---	---	---

Rated voltage	V	300	300
Rated current	A	10	10

Material data

Type of insulating material	PBT
Flammability class acc. UL94	V-0
Contact base material	CuSn
Material of contact surface	tinned

Information

- Additional colours on request
- Rated current related to rated cross-section and min. No. of poles.
- Spacing between rows: see hole layout
- P on drg. = pitch
- Rated data refer only to the component itself. Clearance and creepage distances to other components are to be designed in accordance with the relevant application standards.

Ordering data

Solder pin length	3.2 mm
-------------------	--------

Colour	orange
--------	--------

Pitch 5.08 mm

Poles	L1 mm	(inch)	Qty.	Order No.	Order No.
4	5.08	(0.200)	50		1725170000
6	10.16	(0.400)	50		1725180000
8	15.24	(0.600)	50		1725190000
10	20.32	(0.800)	50		1725200000
12	25.40	(1.000)	50		1725210000
14	30.48	(1.200)	20		1725220000
16	35.56	(1.400)	20		1725230000
18	40.64	(1.600)	20		1725240000
20	45.72	(1.800)	20		1725250000
22	50.80	(2.000)	10		1725260000
24	55.88	(2.200)	10		1725270000
26	60.96	(2.400)	10		1725280000
28	66.04	(2.600)	10		1725290000
30	71.12	(2.800)	10		1725300000
32	76.20	(3.000)	10		1725310000
34	81.28	(3.200)	10		1725320000
36	86.36	(3.400)	10		1725330000
38	91.44	(3.600)	10		1725340000
40	96.52	(3.800)	10		1725350000
42	101.60	(4.000)	10		1725360000
44	106.68	(4.200)	10		1725370000
46	111.76	(4.400)	10		1725380000
48	116.84	(4.600)	10		1725390000

SLD 5.08V/90B

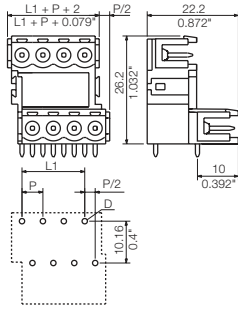

Accessories

Possible colors

Additional colours on request



Coding

See chapter accessories

Ordering data

Solder pin length	3.2 mm
Colour	orange

Pitch 5.08 mm

Poles	L1 mm	(inch)	Qty.	Order No.	Order No.
4	5.08	(0.200)	50		1726280000
6	10.16	(0.400)	50		1726290000
8	15.24	(0.600)	50		1726300000
10	20.32	(0.800)	50		1726310000
12	25.40	(1.000)	50		1726320000
14	30.48	(1.200)	20		1726330000
16	35.56	(1.400)	20		1726340000
18	40.64	(1.600)	20		1726350000
20	45.72	(1.800)	20		1726360000
22	50.80	(2.000)	10		1726370000
24	55.88	(2.200)	10		1726380000
26	60.96	(2.400)	10		1726390000
28	66.04	(2.600)	10		1726400000
30	71.12	(2.800)	10		1726410000
32	20.32	(0.800)	10		1726420000
34	81.28	(3.200)	10		1726430000
36	86.36	(3.400)	10		1726440000
38	91.44	(3.600)	10		1726450000
40	96.52	(3.800)	10		1726460000
42	101.60	(4.000)	10		1726470000
44	106.68	(4.200)	10		1726480000
46	111.76	(4.400)	10		1726490000
48	116.84	(4.600)	10		1726500000



Fixing block

See chapter accessories



Marking strips

See chapter accessories



Compartment partition element

See chapter accessories



Male connectors with solder connection

SLD 5.08V

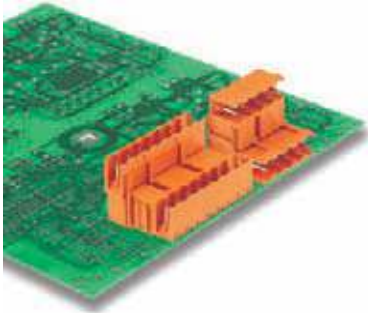

Double level, open ended, offset male connector with straight 180° outlet direction. The solder pin length has been optimised for wave soldering. These male connectors provide space for labelling and can be coded. Supplied in cardboard box.

- 400 V (IEC) / 300 V (UL)
- 17 A (IEC) / 10 A (UL)

Derating curve

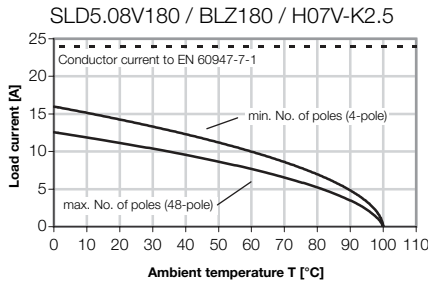

SLD 5.08V/180

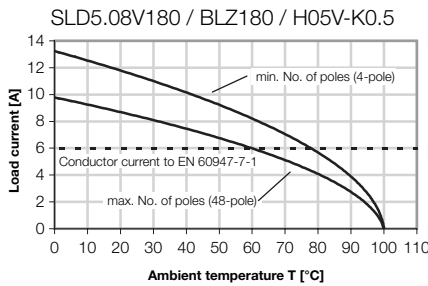
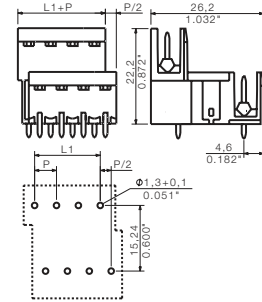

Ordering data

Solder pin length		3.2 mm	
Colour		orange	
Pitch 5.08 mm			
Poles	L1 mm (inch)	Qty.	Order No.
4	5.08 (0.200)	50	1725650000
6	10.16 (0.400)	50	1725660000
8	15.24 (0.600)	50	1725670000
10	20.32 (0.800)	50	1725680000
12	25.40 (1.000)	50	1725690000
14	30.48 (1.200)	20	1725700000
16	35.56 (1.400)	20	1725710000
18	40.64 (1.600)	20	1725720000
20	45.72 (1.800)	20	1725730000
22	50.80 (2.000)	10	1725740000
24	55.88 (2.200)	10	1725750000
26	60.96 (2.400)	10	1725760000
28	66.04 (2.600)	10	1725770000
30	71.12 (2.800)	10	1725780000
32	76.20 (3.000)	10	1725790000
34	81.28 (3.200)	10	1725800000
36	86.36 (3.400)	10	1725810000
38	91.44 (3.600)	10	1725820000
40	96.52 (3.800)	10	1725830000
42	101.60 (4.000)	10	1725840000
44	106.68 (4.200)	10	1725850000
46	111.76 (4.400)	10	1725860000
48	116.84 (4.600)	10	1725870000

F

Technical data

Rated data to IEC 60664-1 / IEC 61984

Clamping range, max.	mm ²		
Solid H05(07) V-U	mm ²		
Stranded H07 V-R	mm ²		
Flexible H05(07) V-K	mm ²		
Flexible with ferrule	mm ²		
Ferrule with plastic collar	mm ²		
Stripping length	mm		
Screwdriver blade	mm		
according to norm			
Tightening torque range	Nm		

Rated current at ambient temperature	20°C		40°C
	A	14	12

Overvoltage category	III	III	II
Pollution severity	3	2	2

Rated voltage	V	250	320	400
Rated impulse voltage	kV	4	4	4

UL 1059 rated data - E60693

	B	C	D
Rated voltage	V	300	300
Rated current	A	10	10

@ CSA C22.2 rated data - LR12400 B

	B	C	D
Rated voltage	V	300	300
Rated current	A	10	10

Material data

Type of insulating material	PBT
Flammability class acc. UL94	V-0
Contact base material	CuSn
Material of contact surface	tinned

Information

- Additional colours on request
- Rated current related to rated cross-section and min. No. of poles.
- Spacing between rows: see hole layout
- P on drg. = pitch
- Rated data refer only to the component itself. Clearance and creepage distances to other components are to be designed in accordance with the relevant application standards.

SLD 5.08V/180B

Accessories

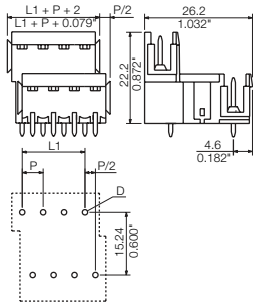

Possible colors

Additional colours on request



Coding

See chapter accessories

Ordering data

Solder pin length	3.2 mm
Colour	orange

Pitch 5.08 mm

Poles	L1 mm	(inch)	Qty.	Order No.	Order No.
4	5.08	(0.200)	50		1726740000
6	10.16	(0.400)	50		1726750000
8	15.24	(0.600)	50		1726760000
10	20.32	(0.800)	50		1726770000
12	25.40	(1.000)	50		1726780000
14	30.48	(1.200)	20		1726790000
16	35.56	(1.400)	20		1726800000
18	40.64	(1.600)	20		1726810000
20	45.72	(1.800)	20		1726820000
22	50.80	(2.000)	10		1726830000
24	55.88	(2.200)	10		1726840000
26	60.96	(2.400)	10		1726850000
28	66.04	(2.600)	10		1726860000
30	71.12	(2.800)	10		1726870000
32	76.20	(3.000)	10		1726880000
34	81.28	(3.200)	10		1726890000
36	86.36	(3.400)	10		1726900000
38	91.44	(3.600)	10		1726910000
40	96.52	(3.800)	10		1726920000
42	101.60	(4.000)	10		1726930000
44	106.68	(4.200)	10		1726940000
46	111.76	(4.400)	10		1726950000
48	116.84	(4.600)	10		1726960000



Fixing block

See chapter accessories



Marking strips

See chapter accessories



Compartment partition element

See chapter accessories



Male connectors with solder connection

SLD 5.08 SLD 5.00

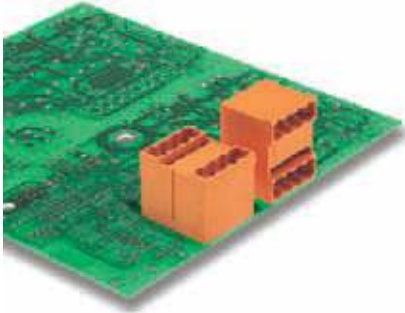

Double level male connector with parallel pin arrangement. The solder pin length has been optimised for wave soldering. These male connectors provide space for labelling and can be coded. Supplied in cardboard box.

- 400 V (IEC) / 300 V (UL)
- 11 A (IEC) / 10 A (UL)

Derating curve

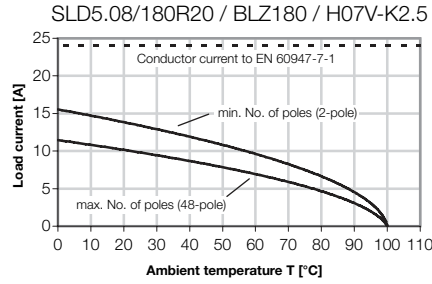

SLD 5.08/90G SLD 5.00/90G

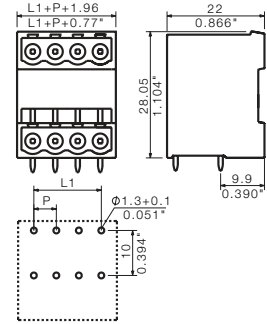

SLD5.08/180R20 / BLZ180 / H05V-K0.5

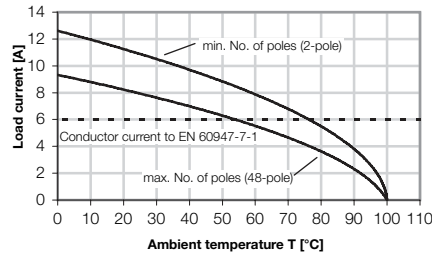

SLD5.08/90R20 / BLZ180 / H07V-K2.5

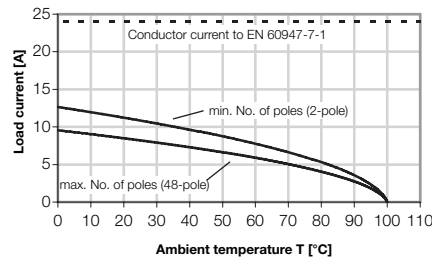

SLD5.08/90R20 / BLZ180 / H05V-K0.5

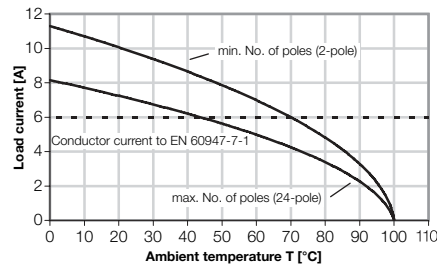

Ordering data

Solder pin length	3.2 mm
Colour	orange

Pitch 5.08 mm					
Poles	L1 mm	(inch)	Qty.	Order No.	Order No.
4	5.08	(0.200)	50		1601790000
6	10.16	(0.400)	50		1601800000
8	15.24	(0.600)	50		1601810000
10	20.32	(0.800)	50		1601820000
12	25.40	(1.000)	50		1601830000
14	30.48	(1.200)	20		1601840000
16	35.56	(1.400)	20		1601850000
18	40.64	(1.600)	20		1601860000
20	45.72	(1.800)	20		1601870000
22	50.80	(2.000)	10		1601880000
24	55.88	(2.200)	10		1601890000
26	60.96	(2.400)	10		1601900000
28	66.04	(2.600)	10		1601910000
30	71.12	(2.800)	10		1601920000
32	76.20	(3.000)	10		1601930000
34	81.28	(3.200)	10		1601940000
36	86.36	(3.400)	10		1601950000
38	91.44	(3.600)	10		1601960000
40	96.52	(3.800)	10		1601970000
42	101.60	(4.000)	10		1601980000
44	106.68	(4.200)	10		1601990000
46	111.76	(4.400)	10		1602000000
48	116.84	(4.600)	10		1602010000

Pitch 5.00 mm					
Poles	L1 mm	(inch)	Qty.	Order No.	Order No.
4	5.00	(0.197)	50		1614350000
6	10.00	(0.394)	50		1614360000
8	15.00	(0.591)	50		1614370000
10	20.00	(0.787)	50		1614380000
12	25.00	(0.984)	50		1614390000
14	30.00	(1.181)	20		1614400000
16	35.00	(1.378)	20		1614410000
18	40.00	(1.575)	20		1614420000
20	45.00	(1.772)	20		1614430000
22	50.00	(1.969)	10		1614440000
24	55.00	(2.165)	10		1614450000
26	60.00	(2.362)	10		1614460000
28	65.00	(2.559)	10		1614470000
30	70.00	(2.756)	10		1614480000
32	75.00	(2.953)	10		1614490000
34	80.00	(3.150)	10		1614500000
36	85.00	(3.346)	10		1614510000
38	90.00	(3.543)	10		1614520000
40	95.00	(3.740)	10		1614530000
42	100.00	(3.937)	10		1614540000
44	105.00	(4.134)	10		1614550000
46	110.00	(4.331)	10		1614560000
48	115.00	(4.528)	10		1614570000

F

Technical data

Rated data to IEC 60664-1 / IEC 61984

Clamping range, max.	mm ²		
Solid H05(07) V-U	mm ²		
Stranded H07 V-R	mm ²		
Flexible H05(07) V-K	mm ²		
Flexible with ferrule	mm ²		
Ferrule with plastic collar	mm ²		
Stripping length	mm		
Screwdriver blade	mm		
according to norm			
Tightening torque range	Nm		

Rated current

at ambient temperature	20°C	40°C
	11	9.5

Overvoltage category

Pollution severity	III	III	II
	3	2	2

Rated voltage	V	250	320	400
Rated impulse voltage	kV	4	4	4

UL 1059 rated data - E60693

	B	C	D
Rated voltage	V	300	300
Rated current	A	10	10

CSA C22.2 rated data - LR12400

	B	C	D
Rated voltage	V	300	300
Rated current	A	10	10

Material data

Type of insulating material	PBT
Flammability class acc. UL94	V-0
Contact base material	CuSn
Material of contact surface	tinned

Information

- Additional colours on request
- Rated current related to rated cross-section and min. No. of poles.
- Spacing between rows: see hole layout
- P on drg. = pitch
- Rated data refer only to the component itself. Clearance and creepage distances to other components are to be designed in accordance with the relevant application standards.

SLD 5.08/180G
SLD 5.00/180G

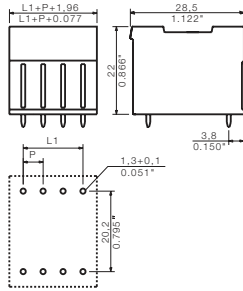
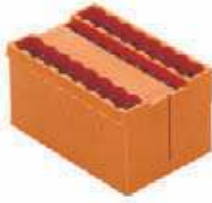

Accessories

Possible colors

Additional colours on request



Coding

See chapter accessories



Marking strips

See chapter accessories



Compartment partition element

See chapter accessories



Ordering data

Solder pin length	3.2 mm
Colour	orange

Pitch 5.08 mm

Poles	L1 mm	(inch)	Qty.	Order No.	Order No.
4	5.08	(0.200)	50		1602390000
6	10.16	(0.400)	50		1602400000
8	15.24	(0.600)	50		1602410000
10	20.32	(0.800)	50		1602420000
12	25.40	(1.000)	50		1602430000
14	30.48	(1.200)	20		1602440000
16	35.56	(1.400)	20		1602450000
18	40.64	(1.600)	20		1602460000
20	45.72	(1.800)	20		1602470000
22	50.80	(2.000)	10		1602480000
24	55.88	(2.200)	10		1602490000
26	60.96	(2.400)	10		1602500000
28	66.04	(2.600)	10		1602510000
30	71.12	(2.800)	10		1602520000
32	76.20	(3.000)	10		1602530000
34	81.28	(3.200)	10		1602540000
36	86.36	(3.400)	10		1602550000
38	91.44	(3.600)	10		1602560000
40	96.52	(3.800)	10		1602570000
42	101.60	(4.000)	10		1602580000
44	106.68	(4.200)	10		1602590000
46	111.76	(4.400)	10		1602600000
48	116.84	(4.600)	10		1602610000

Pitch 5.00 mm

Poles	L1 mm	(inch)	Qty.	Order No.	Order No.
4	5.00	(0.197)	50		1614810000
6	10.00	(0.394)	50		1614820000
8	15.00	(0.591)	50		1614830000
10	20.00	(0.787)	50		1614840000
12	25.00	(0.984)	50		1614850000
14	30.00	(1.181)	20		1614860000
16	35.00	(1.378)	20		1614870000
18	40.00	(1.575)	20		1614880000
20	45.00	(1.772)	20		1614890000
22	50.00	(1.969)	10		1614900000
24	55.00	(2.165)	10		1614910000
26	60.00	(2.362)	10		1614920000
28	65.00	(2.559)	10		1614930000
30	70.00	(2.756)	10		1614940000
32	75.00	(2.953)	10		1614950000
34	80.00	(3.150)	10		1614960000
36	85.00	(3.346)	10		1614970000
38	90.00	(3.543)	10		1614980000
40	95.00	(3.740)	10		1614990000
42	100.00	(3.937)	10		1615000000
44	105.00	(4.134)	10		1615010000
46	110.00	(4.331)	10		1615020000
48	115.00	(4.528)	10		1615030000

Male connectors with spade/solder connection

SLDF 5.08



Male connector for through-panel mounting with optional locking function. The wire contact points have been designed to offer a choice between a permanent manually soldered connection or a removable 2.8mm Faston crimp connection method. These male connectors provide space for labelling and can be coded. Supplied in cardboard box.

- 400 V (IEC) / 300 V (UL)
- 15 A (IEC) / 10 A (UL)

Derating curve

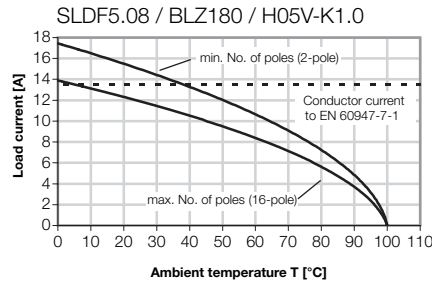

SLDF 5.08 L/F

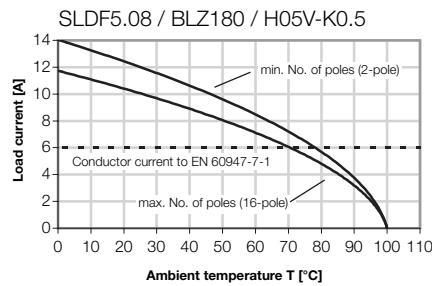
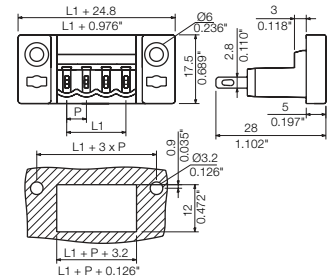

Ordering data

Solder pin length

Colour orange

Pitch 5.08 mm

Poles	L1 mm	(inch)	Qty.	Order No.	Order No.
2	5.08	(0.200)	100	1599130000	
3	10.16	(0.400)	100	1599140000	
4	15.24	(0.600)	100	1599150000	
5	20.32	(0.800)	50	1599160000	
6	25.40	(1.000)	50	1599170000	
7	30.48	(1.200)	50	1599180000	
8	35.56	(1.400)	50	1599190000	
9	40.64	(1.600)	50	1599200000	
10	45.72	(1.800)	50	1599210000	
11	50.80	(2.000)	50	1599220000	
12	55.88	(2.200)	50	1599230000	
13	60.96	(2.400)	50	1599240000	
14	66.04	(2.600)	50	1599250000	
15	71.12	(2.800)	50	1599260000	
16	76.20	(3.000)	50	1599270000	

Technical data

Rated data to IEC 60664-1 / IEC 61984

Clamping range, max.	mm ²	
Solid H05(07) V-U	mm ²	
Stranded H07 V-R	mm ²	
Flexible H05(07) V-K	mm ²	
Flexible with ferrule	mm ²	
Ferrule with plastic collar	mm ²	
Stripping length	mm	
Screwdriver blade	mm	
according to norm		
Tightening torque range	Nm	

Rated current

at ambient temperature	20°C	40°C
A	15	13

Overvoltage category

	III	III	II
Pollution severity	3	2	2

Rated voltage	V	250	320	400
Rated impulse voltage	kV	4	4	4

UL 1059 rated data - E60693

	B	C	D
Rated voltage	V	300	300
Rated current	A	10	10

CSA C22.2 rated data - LR12400 B

	B	C	D
Rated voltage	V	300	300
Rated current	A	10	10

Material data

Type of insulating material	PBT
Flammability class acc. UL94	V-0
Contact base material	CuSn
Material of contact surface	tinned

Information

- Additional colours on request
- Rated current related to rated cross-section and min. No. of poles.
- Solder connection for solid and flexible wires up to 2.5 mm² with insulating/shrink-wrap sleeve, or with 2.8 mm flat blade receptacles with insulated sleeves to DIN IEC 760
- P on drg. = pitch
- Rated data refer only to the component itself. Clearance and creepage distances to other components are to be designed in accordance with the relevant application standards.

Accessories

Possible colors

Additional colours on request



Coding

See chapter accessories



Locking lever

See chapter accessories
1599120000



Marking strips

See chapter accessories



Compartment partition element

See chapter accessories



Male connectors with clamping yoke connection

SLS 5.08/180



Male connector with screw clamping yoke connection for connecting conductors with straight 180° outlet direction. The male connectors provide space for labelling and can be coded. Packed in cardboard box.

- 0.20 - 2.5 mm² (IEC) / 26 - 12 AWG (UL)
- 400 V (IEC) / 300 V (UL)
- 21,5 A (IEC) / 15 A (UL)

Derating curve

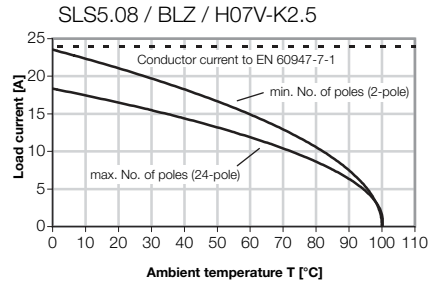

SLS 5.08/180B

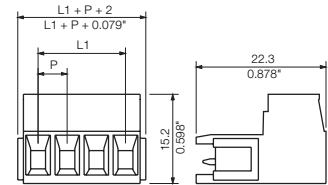

F

Technical data

Rated data to IEC 60664-1 / IEC 61984

Clamping range, max.	mm ²	0.13...3.31
Solid H05(07) V-U	mm ²	0.2...2.5
Stranded H07 V-R	mm ²	
Flexible H05(07) V-K	mm ²	0.2...2.5
Flexible with ferrule	mm ²	0.2...2.5
Ferrule with plastic collar	mm ²	0.2...2.5
Stripping length	mm	7
Screwdriver blade	mm	0.6 x 3.5
according to norm		DIN 5264
Tightening torque range	Nm	0.4...0.5

Rated current

at ambient temperature	20°C	40°C
A	21.5	18

Overvoltage category

Pollution severity	III	III	II
	3	2	2

Rated voltage	V	250	320	400
Rated impulse voltage	kV	4	4	4

UL 1059 rated data - E60693

	B	C	D
Rated voltage	V	300	300
Rated current	A	15	10
AWG conductor		26-12	

CSA C22.2 rated data - LR12400 B

	B	C	D
Rated voltage	V	300	300
Rated current	A	15	10
AWG conductor		26-12	

Material data

Type of insulating material	PBT
Flammability class acc. UL94	V-0
Contact base material	CuSn
Material of contact surface	tinned

Information

- Additional colours on request
- Rated current related to rated cross-section and min. No. of poles.
- Wire end ferrule without plastic collar to DIN 46228 pt 1
- Wire end ferrule with plastic collar to DIN 46228 pt 4
- P on drg. = pitch
- Rated data refer only to the component itself. Clearance and creepage distances to other components are to be designed in accordance with the relevant application standards.

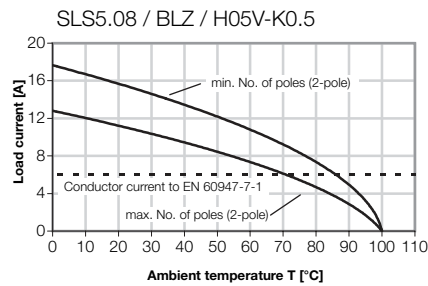

Ordering data

Solder pin length

Colour orange

Pitch 5.08 mm

Poles	L1 mm	(inch)	Qty.	Order No.	Order No.
2	5.08	(0.200)	100	1627240000	
3	10.16	(0.400)	100	1627250000	
4	15.24	(0.600)	100	1627260000	
5	20.32	(0.800)	50	1627270000	
6	25.40	(1.000)	50	1627280000	
7	30.48	(1.200)	50	1627290000	
8	35.56	(1.400)	50	1627300000	
9	40.64	(1.600)	50	1627310000	
10	45.72	(1.800)	50	1627320000	
11	50.80	(2.000)	50	1627330000	
12	55.88	(2.200)	50	1627340000	
13	60.96	(2.400)	50	1627350000	
14	66.04	(2.600)	50	1627360000	
15	71.12	(2.800)	50	1627370000	
16	76.20	(3.000)	50	1627380000	
17	81.28	(3.200)	20	1645150000	
18	86.36	(3.400)	20	1645160000	
19	91.44	(3.600)	20	1645170000	
20	96.52	(3.800)	20	1645180000	
21	101.60	(4.000)	20	1645190000	
22	106.68	(4.200)	20	1645200000	
23	111.76	(4.400)	20	1645210000	
24	116.84	(4.600)	20	1645220000	

SLS 5.08/180F

SLS 5.08/180FI

Accessories

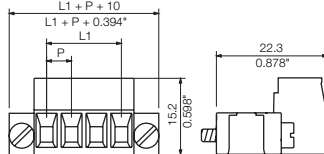
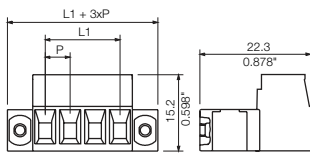

Possible colors

Additional colours on request



Coding

See chapter accessories

Ordering data

Solder pin length

Colour orange

Pitch 5.08 mm

Poles	L1 mm	(inch)	Qty.	Order No.	Order No.
2	5.08	(0.200)	100	1846360000	
3	10.16	(0.400)	100	1846370000	
4	15.24	(0.600)	100	1846380000	
5	20.32	(0.800)	50	1846390000	
6	25.40	(1.000)	50	1846400000	
7	30.48	(1.200)	50	1846410000	
8	35.56	(1.400)	50	1846420000	
9	40.64	(1.600)	50	1846430000	
10	45.72	(1.800)	50	1846440000	
11	50.80	(2.000)	50	1846450000	
12	55.88	(2.200)	50	1846460000	
13	60.96	(2.400)	50	1846470000	
14	66.04	(2.600)	50	1846480000	
15	71.12	(2.800)	50	1846490000	
16	76.20	(3.000)	50	1846500000	

Ordering data

Solder pin length

Colour orange

Pitch 5.08 mm

Poles	L1 mm	(inch)	Qty.	Order No.	Order No.
2	5.08	(0.200)	100	1846210000	
3	10.16	(0.400)	100	1846220000	
4	15.24	(0.600)	100	1846230000	
5	20.32	(0.800)	50	1846240000	
6	25.40	(1.000)	50	1846250000	
7	30.48	(1.200)	50	1846260000	
8	35.56	(1.400)	50	1846270000	
9	40.64	(1.600)	50	1846280000	
10	45.72	(1.800)	50	1846290000	
11	50.80	(2.000)	50	1846300000	
12	55.88	(2.200)	50	1846310000	
13	60.96	(2.400)	50	1846320000	
14	66.04	(2.600)	50	1846330000	
15	71.12	(2.800)	50	1846340000	
16	76.20	(3.000)	50	1846350000	



Marking strips

See chapter accessories



Compartment partition element

See chapter accessories



Screwdriver

See chapter accessories
Order No. 9008390000



SLS 5.08/180TB KF

Accessories

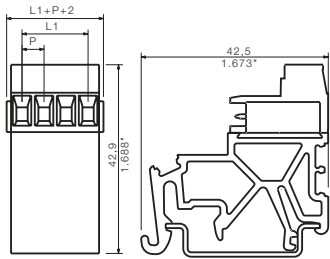

Possible colors

Additional colours on request



Coding

See chapter accessories

Ordering data

Solder pin length

Colour orange

Pitch 5.08 mm

Poles	L1 mm	(inch)	Qty.	Order No.	Order No.
4	15.24	(0.600)	20	1846130000	
6	25.40	(1.000)	20	1846140000	
8	35.56	(1.400)	10	1846150000	
10	45.72	(1.800)	10	1846160000	
12	55.88	(2.200)	10	1846170000	
16	76.20	(3.000)	5	1846180000	
20	96.52	(3.800)	5	1846190000	
24	116.84	(4.600)	5	1846200000	



Fixing block

See chapter accessories

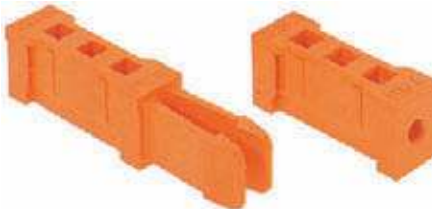

Marking strips

See chapter accessories



Compartment partition element

See chapter accessories



Male connectors with TOP connection

SLT 5.08 B

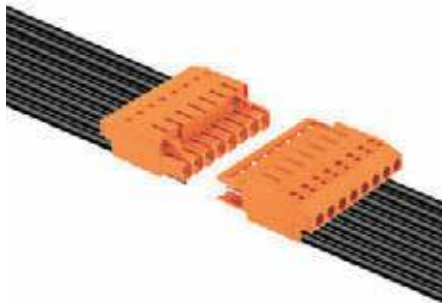

Male connectors with screw TOP connection for connecting conductors with a straight 180° outlet direction. The male connectors provide space for labelling and can be coded. Packed in cardboard box.

- 0.20 - 2.5 mm² (IEC) / 26 - 14 AWG (UL)
- 400 V (IEC) / 300 V (UL)
- 16 A (IEC) / 10 A (UL)

Derating curve

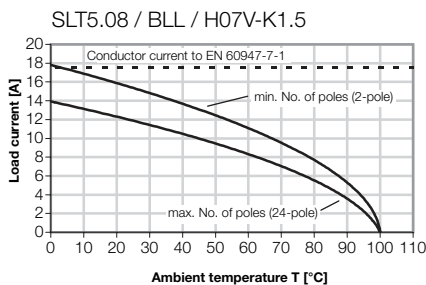

SLT 5.08B

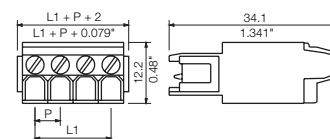

F

Technical data

Rated data to IEC 60664-1 / IEC 61984			
Clamping range, max.	mm ²	0.13...2.5	
Solid H05(07) V-U	mm ²	0.2...2.5	
Stranded H07 V-R	mm ²		
Flexible H05(07) V-K	mm ²	0.2...1.5	
Flexible with ferrule	mm ²	0.2...1.5	
Ferrule with plastic collar	mm ²	0.2...1.5	
Stripping length	mm	13	
Screwdriver blade	mm	0.6 x 3.5	
according to norm		DIN 5264	
Tightening torque range	Nm	0.4...0.5	
Rated current at ambient temperature			
	A	20°C	40°C
		16	13
Overvoltage category			
		III	III
Pollution severity			
		3	2
Rated voltage	V	250	400
Rated impulse voltage	kV	4	4
UL 1059 rated data - E60693			
		B	C
Rated voltage	V	300	300
Rated current	A	10	10
AWG conductor		26-14	
CSA C22.2 rated data - LR12400 B			
		B	C
Rated voltage	V	300	300
Rated current	A	10	10
AWG conductor		26-14	
Material data			
Type of insulating material		PBT	
Flammability class acc. UL94		V-0	
Contact base material		CuSn	
Material of contact surface		tinned	
Information			

- Additional colours on request
- Rated current related to rated cross-section and min. No. of poles.
- Wire end ferrule without plastic collar to DIN 46228 pt 1
- Wire end ferrule with plastic collar to DIN 46228 pt 4
- Crimp form A for wire end ferrules with PZ 6/5 crimping tool are recommended for the largest cable sizes.
- P on drg. = pitch
- Rated data refer only to the component itself. Clearance and creepage distances to other components are to be designed in accordance with the relevant application standards.

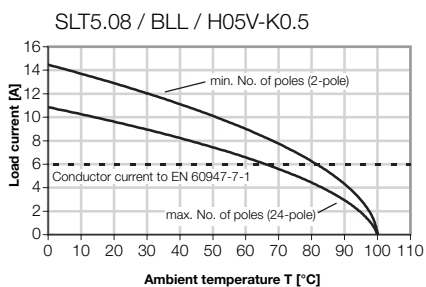

Ordering data

Solder pin length					
Colour					
					orange
Pitch 5.08 mm					
Poles	L1 mm	(inch)	Qty.	Order No.	Order No.
2	5.08	(0.200)	100	1611710000	
3	10.16	(0.400)	100	1611720000	
4	15.24	(0.600)	100	1611730000	
5	20.32	(0.800)	50	1611740000	
6	25.40	(1.000)	50	1611750000	
7	30.48	(1.200)	50	1611760000	
8	35.56	(1.400)	50	1611770000	
9	40.64	(1.600)	50	1611780000	
10	45.72	(1.800)	50	1611790000	
11	50.80	(2.000)	50	1611800000	
12	55.88	(2.200)	50	1611810000	
13	60.96	(2.400)	50	1611820000	
14	66.04	(2.600)	50	1611830000	
15	71.12	(2.800)	50	1611840000	
16	76.20	(3.000)	50	1611850000	

Accessories

Possible colors

Additional colours on request



Coding

See chapter accessories



Fixing block

See chapter accessories



Marking strips

See chapter accessories



Compartment partition element

See chapter accessories



Male connectors with tension clamp connection

SLZF 5.08/180

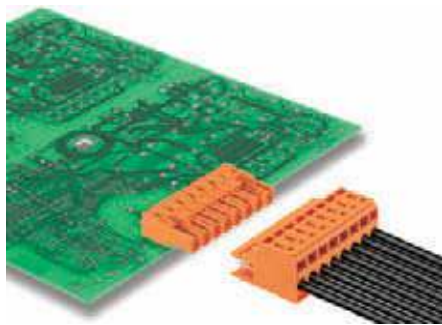

Male connector for connecting conductors using tension clamp method with straight 180° outlet direction. The male connectors provide space for labelling and can be coded. Packed in cardboard box.

- 0.20 - 2.5 mm² (IEC) / 26 - 14 AWG (UL)
- 400 V (IEC) / 300 V (UL)
- 23 A (IEC) / 15 A (UL)

Derating curve

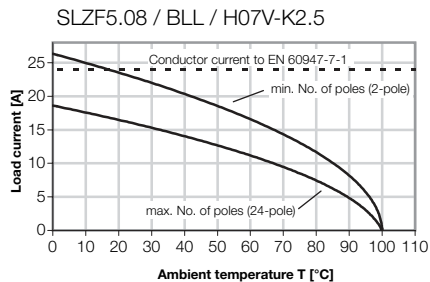

SLZF 5.08/180B

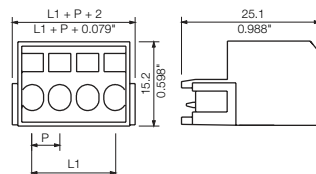

F

Technical data

Rated data to IEC 60664-1 / IEC 61984			
Clamping range, max.	mm ²	0.13...3.31	
Solid H05(07) V-U	mm ²	0.2...2.5	
Stranded H07 V-R	mm ²		
Flexible H05(07) V-K	mm ²	0.2...2.5	
Flexible with ferrule	mm ²	0.2...2.5	
Ferrule with plastic collar	mm ²	0.2...1.5	
Stripping length	mm	10	
Screwdriver blade	mm	0.6 x 3.5	
according to norm		DIN 5264-A	
Tightening torque range	Nm		
Rated current at ambient temperature			
	A	20°C	40°C
		23	20
Overvoltage category			
		III	III
Pollution severity			
		3	2
Rated voltage	V	250	320
Rated impulse voltage	kV	4	4
UL 1059 rated data - E60693			
		B	C
Rated voltage	V	300	300
Rated current	A	15	10
AWG conductor		26-12	
CSA C22.2 rated data - LR12400 B			
		B	C
Rated voltage	V	300	300
Rated current	A	15	10
AWG conductor		26-12	
Material data			
Type of insulating material		PBT	
Flammability class acc. UL94		V-0	
Contact base material		Cu alloy	
Material of contact surface		tinned	
Information			

- Additional colours on request
- Rated current related to rated cross-section and min. No. of poles.
- Wire end ferrule without plastic collar to DIN 46228 pt 1
- Wire end ferrule with plastic collar to DIN 46228 pt 4
- P on drg. = pitch
- Rated data refer only to the component itself. Clearance and creepage distances to other components are to be designed in accordance with the relevant application standards.

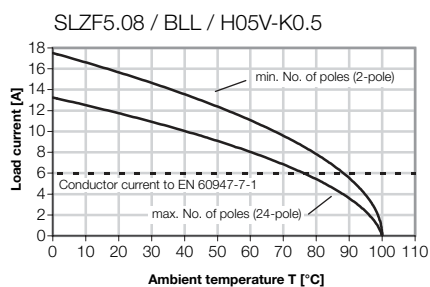

Ordering data

Solder pin length					
Colour					
					orange
Pitch 5.08 mm					
Poles	L1 mm	(inch)	Qty.	Order No.	Order No.
2	5.08	(0.200)	100	1710210000	
3	10.16	(0.400)	100	1710220000	
4	15.24	(0.600)	100	1710230000	
5	20.32	(0.800)	50	1710240000	
6	25.40	(1.000)	50	1710250000	
7	30.48	(1.200)	50	1710260000	
8	35.56	(1.400)	50	1710270000	
9	40.64	(1.600)	50	1710280000	
10	45.72	(1.800)	50	1710290000	
11	50.80	(2.000)	50	1710300000	
12	55.88	(2.200)	50	1710310000	
13	60.96	(2.400)	50	1710320000	
14	66.04	(2.600)	50	1710330000	
15	71.12	(2.800)	50	1710340000	
16	76.20	(3.000)	50	1710350000	
17	81.28	(3.200)	20	1710360000	
18	86.36	(3.400)	20	1710370000	
19	91.44	(3.600)	20	1710380000	
20	96.52	(3.800)	20	1710390000	
21	101.60	(4.000)	20	1710400000	
22	106.68	(4.200)	20	1710410000	
23	111.76	(4.400)	20	1710420000	
24	116.84	(4.600)	20	1710430000	

SLZF 5.08/180F

SLZF 5.08/180FI

Accessories

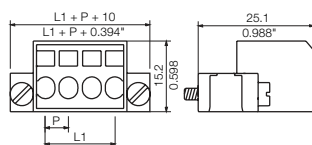
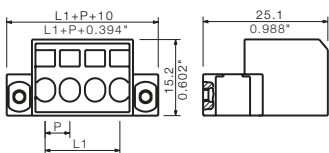

Possible colors
Additional colours on request



Coding
See chapter accessories



Cable grip
See chapter accessories



Marking strips
See chapter accessories



Compartment partition element
See chapter accessories



Ordering data

Solder pin length
Colour orange

Pitch 5.08 mm					
Poles	L1 mm	(inch)	Qty.	Order No.	Order No.
2	5.08	(0.200)	100	1846930000	
3	10.16	(0.400)	100	1846940000	
4	15.24	(0.600)	100	1846950000	
5	20.32	(0.800)	50	1846970000	
6	25.40	(1.000)	50	1846980000	
7	30.48	(1.200)	50	1846990000	
8	35.56	(1.400)	50	1847000000	
9	40.64	(1.600)	50	1847020000	
10	45.72	(1.800)	50	1847040000	
11	50.80	(2.000)	50	1847060000	
12	55.88	(2.200)	50	1847080000	
13	60.96	(2.400)	50	1847100000	
14	66.04	(2.600)	50	1847130000	
15	71.12	(2.800)	50	1847150000	
16	76.20	(3.000)	50	1847170000	
17	81.28	(3.200)	20	1847200000	
18	86.36	(3.400)	20	1847220000	
19	91.44	(3.600)	20	1847240000	
20	96.52	(3.800)	20	1847250000	
21	101.60	(4.000)	20	1847260000	
22	106.68	(4.200)	20	1847270000	
23	111.76	(4.400)	20	1847280000	
24	116.84	(4.600)	20	1847290000	

Ordering data

Solder pin length
Colour orange

Pitch 5.08 mm					
Poles	L1 mm	(inch)	Qty.	Order No.	Order No.
2	5.08	(0.200)	100	1846510000	
3	10.16	(0.400)	100	1846520000	
4	15.24	(0.600)	100	1846530000	
5	20.32	(0.800)	50	1846540000	
6	25.40	(1.000)	50	1846550000	
7	30.48	(1.200)	50	1846560000	
8	35.56	(1.400)	50	1846570000	
9	40.64	(1.600)	50	1846580000	
10	45.72	(1.800)	50	1846590000	
11	50.80	(2.000)	50	1846600000	
12	55.88	(2.200)	50	1846610000	
13	60.96	(2.400)	50	1846620000	
14	66.04	(2.600)	50	1846630000	
15	71.12	(2.800)	50	1846640000	
16	76.20	(3.000)	50	1846650000	
17	81.28	(3.200)	20	1846660000	
18	86.36	(3.400)	20	1846670000	
19	91.44	(3.600)	20	1846680000	
20	96.52	(3.800)	20	1846690000	
21	101.60	(4.000)	20	1846700000	
22	106.68	(4.200)	20	1846710000	
23	111.76	(4.400)	20	1846720000	
24	116.84	(4.600)	20	1846730000	

Male connectors with tension clamp connection

SLZF 5.08/90

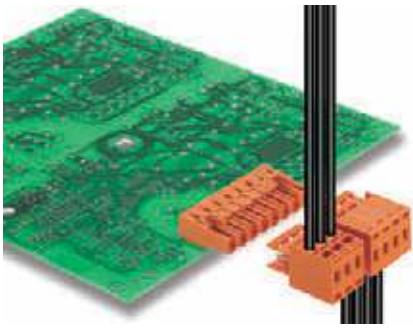

Male connector for connecting conductors with 90° or 270° outlet direction with proven tension clamp connection. The male connectors provide space for labelling and can be coded. Packed in cardboard box.

- 0.20 - 2.5 mm² (IEC) / 26 - 14 AWG (UL)
- 400 V (IEC) / 300 V (UL)
- 20,5 A (IEC) / 15 A (UL)

Derating curve

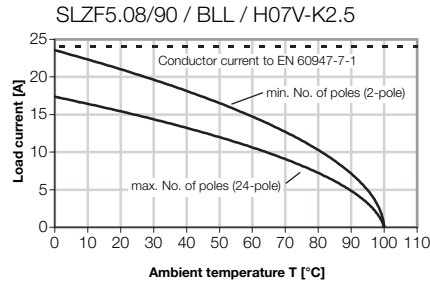

SLZF 5.08/90B

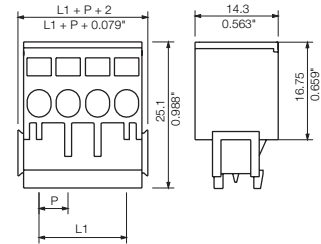

F

Technical data

Rated data to IEC 60664-1 / IEC 61984

Clamping range, max.	mm ²	0.08...3.31
Solid H05(07) V-U	mm ²	0.2...2.5
Stranded H07 V-R	mm ²	
Flexible H05(07) V-K	mm ²	0.2...2.5
Flexible with ferrule	mm ²	0.2...2.5
Ferrule with plastic collar	mm ²	0.2...1.5
Stripping length	mm	10
Screwdriver blade	mm	0.6 x 3.5
according to norm		DIN 5264-A
Tightening torque range	Nm	

Rated current

at ambient temperature	20°C	40°C
A	20.5	18

Overvoltage category

	III	III	II
Pollution severity	3	2	2

Rated voltage	V	250	320	400
Rated impulse voltage	kV	4	4	4

UL 1059 rated data - E60693

	B	C	D
Rated voltage	V	300	300
Rated current	A	15	10
AWG conductor		26-12	

CSA C22.2 rated data - LR12400 B

	B	C	D
Rated voltage	V	300	300
Rated current	A	15	10
AWG conductor		26-12	

Material data

Type of insulating material	PBT
Flammability class acc. UL94	V-0
Contact base material	CuSn
Material of contact surface	tinned

Information

- Additional colours on request
- Rated current related to rated cross-section and min. No. of poles.
- Wire end ferrule without plastic collar to DIN 46228 pt 1
- Wire end ferrule with plastic collar to DIN 46228 pt 4
- P on drg. = pitch
- Rated data refer only to the component itself. Clearance and creepage distances to other components are to be designed in accordance with the relevant application standards.

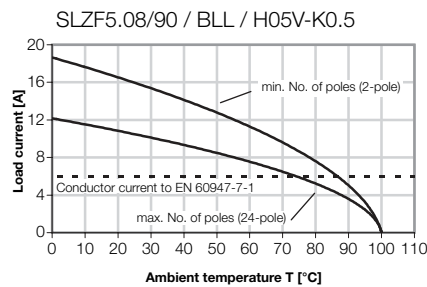

Ordering data

Solder pin length

Colour orange

Pitch 5.08 mm

Poles	L1 mm	(inch)	Qty.	Order No.	Order No.
2	5.08	(0.200)	100	1673550000	
3	10.16	(0.400)	100	1673560000	
4	15.24	(0.600)	100	1673570000	
5	20.32	(0.800)	50	1673580000	
6	25.40	(1.000)	50	1673590000	
7	30.48	(1.200)	50	1673600000	
8	35.56	(1.400)	50	1673610000	
9	40.64	(1.600)	50	1673620000	
10	45.72	(1.800)	50	1673630000	
11	50.80	(2.000)	50	1673640000	
12	55.88	(2.200)	50	1673650000	
13	60.96	(2.400)	50	1673660000	
14	66.04	(2.600)	50	1673670000	
15	71.12	(2.800)	50	1673680000	
16	76.20	(3.000)	50	1673690000	
17	81.28	(3.200)	20	1673700000	
18	86.36	(3.400)	20	1673710000	
19	91.44	(3.600)	20	1673720000	
20	96.52	(3.800)	20	1673730000	
21	101.60	(4.000)	20	1673740000	
22	106.68	(4.200)	20	1673750000	
23	111.76	(4.400)	20	1673760000	
24	116.84	(4.600)	20	1673770000	

SLZF 5.08/270B

Accessories

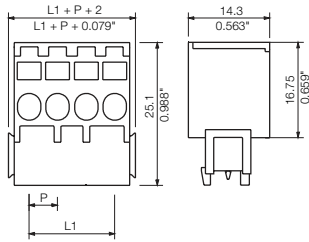

Possible colors
Additional colours on request



Coding
See chapter accessories

Ordering data

Solder pin length

Colour orange

Pitch 5.08 mm

Poles	L1 mm	(inch)	Qty.	Order No.	Order No.
2	5.08	(0.200)	100	1706140000	
3	10.16	(0.400)	100	1706150000	
4	15.24	(0.600)	100	1706160000	
5	20.32	(0.800)	50	1706170000	
6	25.40	(1.000)	50	1706180000	
7	30.48	(1.200)	50	1706190000	
8	35.56	(1.400)	50	1706200000	
9	40.64	(1.600)	50	1706210000	
10	45.72	(1.800)	50	1706220000	
11	50.80	(2.000)	50	1706230000	
12	55.88	(2.200)	50	1706240000	
13	60.96	(2.400)	50	1706250000	
14	66.04	(2.600)	50	1706260000	
15	71.12	(2.800)	50	1706270000	
16	76.20	(3.000)	50	1706280000	
17	81.28	(3.200)	20	1706290000	
18	86.36	(3.400)	20	1706300000	
19	91.44	(3.600)	20	1706310000	
20	96.52	(3.800)	20	1706320000	
21	101.60	(4.000)	20	1706330000	
22	106.68	(4.200)	20	1706340000	
23	111.76	(4.400)	20	1706350000	
24	116.84	(4.600)	20	1706360000	



Fixing block
See chapter accessories



Marking strips
See chapter accessories



Compartment partition element
See chapter accessories



Socket connectors with clamping yoke connection

Omnimate Range
pitch 5.00 / 5.08

BLZ 5.08/180 BLZ 5.00/180

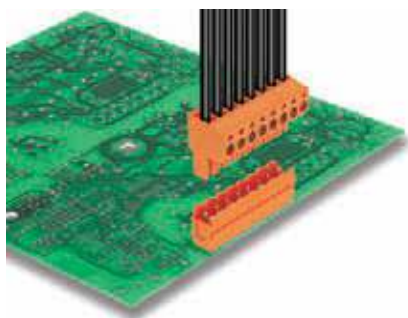

Socket connectors with clamping yoke screw connection for conductor connection with straight 180° outlet direction. The socket connectors provide space for labelling and can be coded. Packaged in cardboard box.

- 0.20 - 2,5 mm² (IEC) / 26 - 12 AWG (UL)
- 400 V (IEC) / 300 V (UL)
- 19 A (IEC) / 15 A (UL)

Derating curve

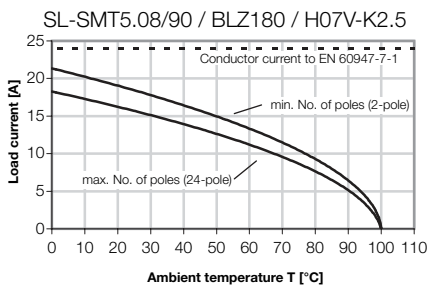

BLZ 5.08/180 BLZ 5.00/180

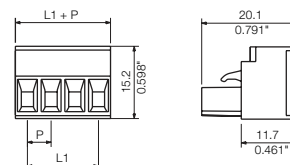

Technical data

Rated data to IEC 60664-1 / IEC 61984			
Clamping range, max.	mm ²	0.13...3.31	
Solid H05(07) V-U	mm ²	0.2...2.5	
Stranded H07 V-R	mm ²		
Flexible H05(07) V-K	mm ²	0.2...2.5	
Flexible with ferrule	mm ²	0.2...2.5	
Ferrule with plastic collar	mm ²	0.2...2.5	
Stripping length	mm	7	
Screwdriver blade	mm	0.6 x 3.5	
according to norm		DIN 5264	
Tightening torque range	Nm	0.4...0.5	
Rated current at ambient temperature			
	A	20°C	40°C
		19	16
Overvoltage category			
		III	III
Pollution severity			
		3	2
Rated voltage	V	250	320
Rated impulse voltage	kV	4	4
UL 1059 rated data - E60693			
		B	C
Rated voltage	V	300	300
Rated current	A	15	10
AWG conductor		26-12	
CSA C22.2 rated data - LR12400 B			
		B	C
Rated voltage	V	300	300
Rated current	A	15	10
AWG conductor		26-12	
Material data			
Type of insulating material		PBT	
Flammability class acc. UL94		V-0	
Contact base material		Cu alloy	
Material of contact surface		tinned	

- #### Information
- Additional colours on request
 - Gold-plated contact surfaces on request
 - Rated current related to rated cross-section and min. No. of poles.
 - Wire end ferrule without plastic collar to DIN 46228 pt 1
 - Wire end ferrule with plastic collar to DIN 46228 pt 4
 - P on drg. = pitch
 - Rated data refer only to the component itself. Clearance and creepage distances to other components are to be designed in accordance with the relevant application standards.

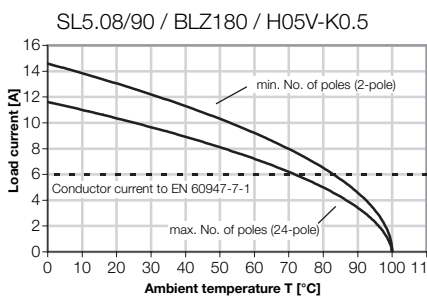
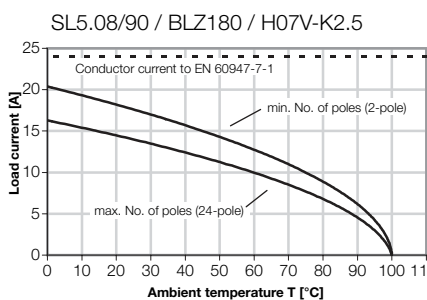
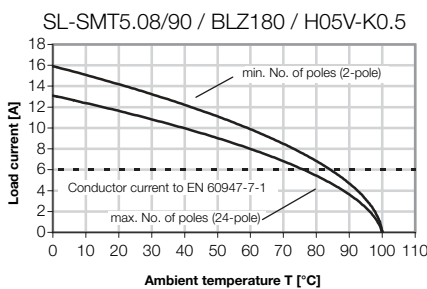

Ordering data

Solder pin length					
Colour		orange	black		
Pitch 5.08 mm					
Poles	L1 mm	(inch)	Qty.	Order No.	Order No.
2	5.08	(0.200)	100	1526460000	1526410000
3	10.16	(0.400)	100	1526560000	1526510000
4	15.24	(0.600)	100	1526660000	1526610000
5	20.32	(0.800)	50	1526760000	1526710000
6	25.40	(1.000)	50	1526860000	1526810000
7	30.48	(1.200)	50	1526960000	1526910000
8	35.56	(1.400)	50	1527060000	1527010000
9	40.64	(1.600)	50	1527160000	1527110000
10	45.72	(1.800)	50	1527260000	1527210000
11	50.80	(2.000)	50	1527360000	1527310000
12	55.88	(2.200)	50	1527460000	1527410000
13	60.96	(2.400)	50	1527560000	1527510000
14	66.04	(2.600)	50	1527660000	1527610000
15	71.12	(2.800)	50	1527760000	1527710000
16	76.20	(3.000)	50	1527860000	1527810000
17	81.28	(3.200)	20	1527960000	1527910000
18	86.36	(3.400)	20	1528060000	1528010000
19	91.44	(3.600)	20	1528160000	1528110000
20	96.52	(3.800)	20	1528260000	1528210000
21	101.60	(4.000)	20	1528360000	1528310000
22	106.68	(4.200)	20	1528460000	1528410000
23	111.76	(4.400)	20	1528560000	1528510000
24	116.84	(4.600)	20	1528660000	1528610000
Pitch 5.00 mm					
Poles	L1 mm	(inch)	Qty.	Order No.	Order No.
2	5.00	(0.197)	100	1571350000	1625610000
3	10.00	(0.394)	100	1571360000	1625620000
4	15.00	(0.591)	100	1571370000	1596080000
5	20.00	(0.787)	50	1571380000	1625630000
6	25.00	(0.984)	50	1571390000	1596090000
7	30.00	(1.181)	50	1571400000	1596100000
8	35.00	(1.378)	50	1571410000	1596110000
9	40.00	(1.575)	50	1571420000	1625640000
10	45.00	(1.772)	50	1571430000	1596120000
11	50.00	(1.969)	50	1571440000	1625650000
12	55.00	(2.165)	50	1571450000	1602990000
13	60.00	(2.362)	50	1571460000	1625660000
14	65.00	(2.559)	50	1571470000	1625670000
15	70.00	(2.756)	50	1571480000	1625680000
16	75.00	(2.953)	50	1571490000	1603300000
17	80.00	(3.150)	20	1571500000	1625690000
18	85.00	(3.347)	20	1571510000	1625700000
19	90.00	(3.543)	20	1571520000	1625710000
20	95.00	(3.740)	20	1571530000	1625720000
21	100.00	(3.937)	20	1571540000	1625730000
22	105.00	(4.134)	20	1571550000	1625740000
23	110.00	(4.331)	20	1571560000	1625750000
24	115.00	(4.528)	20	1571570000	1611470000

Socket connectors with clamping yoke connection

BLZ 5.08/180 BLZ 5.00/180

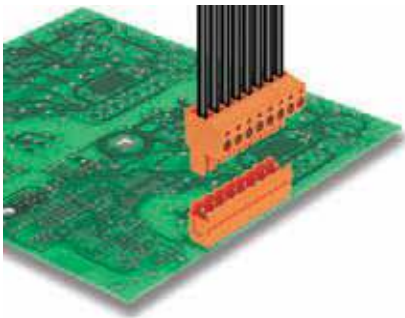

Socket connectors with clamping yoke screw connection for conductor connection with straight 180° outlet direction and release lever (LH) or release bar (LR) mechanisms. The socket connectors provide space for labelling and can be coded. Packaged in cardboard box.

- 0.20 - 2,5 mm² (IEC) / 26 - 12 AWG (UL)
- 400 V (IEC) / 300 V (UL)
- 19 A (IEC) / 15 A (UL)

Derating curve

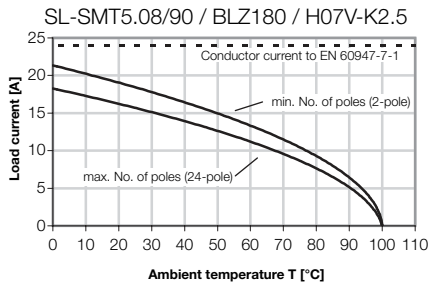

BLZ 5.08/180LH

with release lever

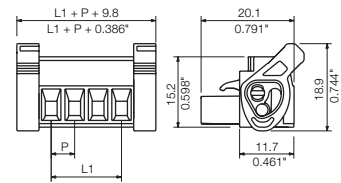

F

Technical data

Rated data to IEC 60664-1 / IEC 61984

Clamping range, max.	mm ²	0.13...3.31
Solid H05(07) V-U	mm ²	0.2...2.5
Stranded H07 V-R	mm ²	
Flexible H05(07) V-K	mm ²	0.2...2.5
Flexible with ferrule	mm ²	0.2...2.5
Ferrule with plastic collar	mm ²	0.2...2.5
Stripping length	mm	7
Screwdriver blade	mm	0.6 x 3.5
according to norm		DIN 5264
Tightening torque range	Nm	0.4...0.5

Rated current

at ambient temperature	20°C	40°C
A	19	16

Overtoltage category

III	III	II
-----	-----	----

Pollution severity

3	2	2
---	---	---

Rated voltage	V	250	320	400
Rated impulse voltage	kV	4	4	4

UL 1059 rated data - E60693

		B	C	D
Rated voltage	V	300	300	300
Rated current	A	15	10	10
AWG conductor		26-12		

CSA C22.2 rated data - LR12400 B

		B	C	D
Rated voltage	V	300	300	300
Rated current	A	15	10	10
AWG conductor		26-12		

Material data

Type of insulating material	PBT
Flammability class acc. UL94	V-0
Contact base material	Cu alloy
Material of contact surface	tinned

Information

- Additional colours on request
- Gold-plated contact surfaces on request
- Rated current related to rated cross-section and min. No. of poles.
- Wire end ferrule without plastic collar to DIN 46228 pt 1
- Wire end ferrule with plastic collar to DIN 46228 pt 4
- P on drg. = pitch
- Rated data refer only to the component itself. Clearance and creepage distances to other components are to be designed in accordance with the relevant application standards.

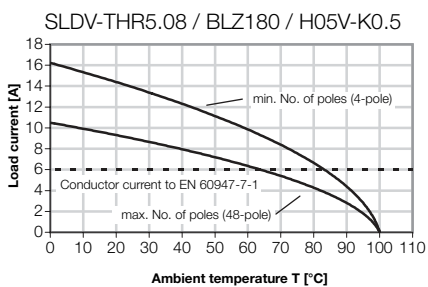
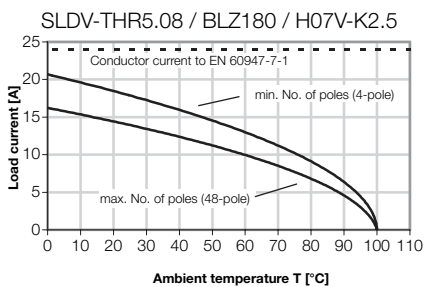
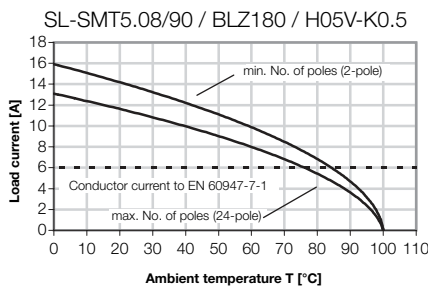

Ordering data

Solder pin length

Colour	orange	black
--------	--------	-------

Pitch 5.08 mm

Poles	L1 mm	(inch)	Qty.	Order No.	Order No.
2	5.08	(0.200)	100	1892190000	1893600000
3	10.16	(0.400)	100	1892200000	1893610000
4	15.24	(0.600)	100	1892210000	1893620000
5	20.32	(0.800)	50	1892220000	1893630000
6	25.40	(1.000)	50	1892230000	1893640000
7	30.48	(1.200)	50	1892240000	1893650000
8	35.56	(1.400)	50	1892250000	1893660000
9	40.64	(1.600)	50	1892260000	1893670000
10	45.72	(1.800)	50	1892270000	1893680000
11	50.80	(2.000)	50	1892280000	1893690000
12	55.88	(2.200)	50	1892290000	1893700000
13	60.96	(2.400)	50	1892300000	1893710000
14	66.04	(2.600)	50	1892310000	1893720000
15	71.12	(2.800)	50	1892320000	1893730000
16	76.20	(3.000)	50	1892330000	1893740000
17	81.28	(3.200)	20	1892340000	1893750000
18	86.36	(3.400)	20	1892350000	1893760000
19	91.44	(3.600)	20	1892360000	1893770000
20	96.52	(3.800)	20	1892370000	1893780000
21	101.60	(4.000)	20	1892380000	1893790000
22	106.68	(4.200)	20	1892390000	1893800000

BLZ 5.08/180LR

with release bar

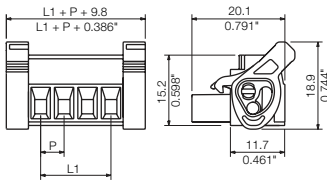

Ordering data

Solder pin length

Colour	orange	black
--------	---------------	--------------

Pitch 5.08 mm

Poles	L1 mm	(inch)	Qty.	Order No.	Order No.
2	5.08	(0.200)	100	1851200000	1892950000
3	10.16	(0.400)	100	1851210000	1892960000
4	15.24	(0.600)	100	1851220000	1892970000
5	20.32	(0.800)	50	1851230000	1892980000
6	25.40	(1.000)	50	1851240000	1892990000
7	30.48	(1.200)	50	1851250000	1893000000
8	35.56	(1.400)	50	1851260000	1893010000
9	40.64	(1.600)	50	1851270000	1893020000
10	45.72	(1.800)	50	1851280000	1893030000
11	50.80	(2.000)	50	1851290000	1893040000
12	55.88	(2.200)	50	1851300000	1893050000
13	60.96	(2.400)	50	1851310000	1893060000
14	66.04	(2.600)	50	1851320000	1893070000
15	71.12	(2.800)	50	1851330000	1893080000
16	76.20	(3.000)	50	1851340000	1893090000
17	81.28	(3.200)	20	1851350000	1893100000
18	86.36	(3.400)	20	1851360000	1893110000
19	91.44	(3.600)	20	1851370000	1893120000
20	96.52	(3.800)	20	1851380000	1893130000
21	101.60	(4.000)	20	1851390000	1893140000
22	106.68	(4.200)	20	1851400000	1893150000

Accessories

Possible colors

Additional colours on request



Coding

See chapter accessories



Cable grip

See chapter accessories



Hood

See chapter accessories



Marking strips

See chapter accessories



**LH release lever
LR release bar**

In confined space it is often difficult to gain access to and grab the plug-in connectors.

In order to be able to separate male and female connectors easily, Weidmüller has developed special connectors with a release lever. The release lever has to be braced against a surface in order to operate properly. This is achieved by using male connectors with a fixed flange, or devices with a suitably designed front panel. The lever can be operated either by hand or with a screwdriver.



plugged in



released

In addition to its release function, the release bar, in combination with the flange versions of the SL-SMT male connectors, also has a "locking" function. After the connector has been plugged in, the release bar is locked. Releasing this enables the plug-in connector to be easily separated again. The lever can be operated either by hand or with a screwdriver.



locked



released

Socket connectors with clamping yoke connection

BLZ 5.08 QV

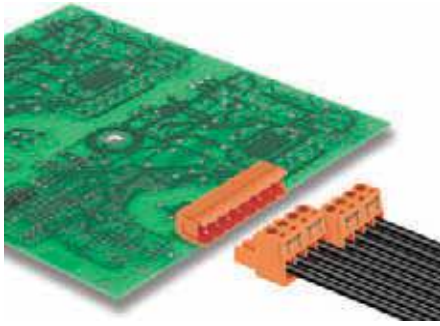

Socket connectors with clamping yoke screw connection for conductor connection with straight 180° outlet direction and internal cross-connection for connections 1-2 and 3-4. Bus current up to 32 A for 4 mm² (without wire end ferrules). The socket connectors provide space for labelling and can be coded. Packaged in cardboard box.

- 0.20 - 2,5 mm² (IEC) / 26 - 14 AWG (UL)
- 400 V (IEC) / 300 V (UL)
- 17,5 A (IEC) / 10 A (UL)

Derating curve

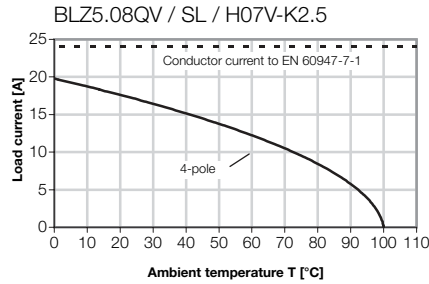

BLZ 5.08 QV2

with cross-connection

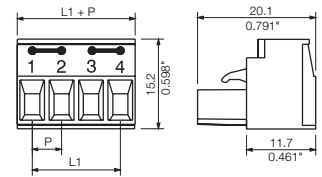

F

Technical data

Rated data to IEC 60664-1 / IEC 61984

Clamping range, max.	mm ²	0.13...3.31
Solid H05(07) V-U	mm ²	0.2...2.5
Stranded H07 V-R	mm ²	
Flexible H05(07) V-K	mm ²	0.2...4
Flexible with ferrule	mm ²	0.2...2.5
Ferrule with plastic collar	mm ²	0.2...2.5
Stripping length	mm	7
Screwdriver blade	mm	0.6 x 3.5
according to norm		DIN 5264
Tightening torque range	Nm	0.4...0.5

Rated current

at ambient temperature		20°C	40°C
	A	17.5	15

Overvoltage category

	III	III	II
Pollution severity	3	2	2

	250	320	400
Rated voltage	V		

	4	4	4
Rated impulse voltage	kV		

UL 1059 rated data - E60693

	B	C	D
Rated voltage	V	300	300

	A	15	10
Rated current	A		

		26-12
AWG conductor		

CSA C22.2 rated data - LR12400 B

	B	C	D
Rated voltage	V	300	300

	A	15	10
Rated current	A		

		26-12
AWG conductor		

Material data

Type of insulating material	PBT
-----------------------------	-----

Flammability class acc. UL94	V-0
------------------------------	-----

Contact base material	Cu alloy
-----------------------	----------

Material of contact surface	tinned
-----------------------------	--------

Information

- Additional colours on request
- Gold-plated contact surfaces on request
- Rated current related to rated cross-section and min. No. of poles.
- Wire end ferrule without plastic collar to DIN 46228 pt 1
- Wire end ferrule with plastic collar to DIN 46228 pt 4
- P on drg. = pitch
- Rated data refer only to the component itself. Clearance and creepage distances to other components are to be designed in accordance with the relevant application standards.

Ordering data

Solder pin length

Colour	<input checked="" type="checkbox"/> orange	<input type="checkbox"/> black
--------	--	--------------------------------

Pitch 5.08 mm

Poles	L1 mm	(inch)	Qty.	Order No.	Order No.
4	15.24	(0.300)	100	1839770000	1839780000

BLZ 5.08F QV2

with cross-connection

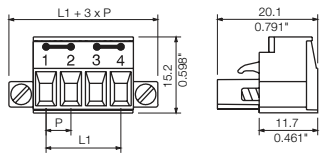

Accessories

Possible colors

Additional colours on request



Coding

See chapter accessories



Cable grip

See chapter accessories



Hood

See chapter accessories



Marking strips

See chapter accessories



Ordering data

Solder pin length

Colour	<input checked="" type="checkbox"/> orange	<input type="checkbox"/> black
--------	--	--------------------------------

Pitch 5.08 mm

Poles	L1 mm	(inch)	Qty.	Order No.	Order No.
4	15.24	(0.300)	100	1846870000	1844500000

Socket connectors with clamping yoke connection

BLZ 5.08/90
BLZ 5.00/90

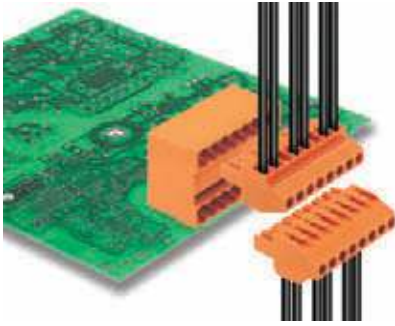

Socket connectors with clamping yoke screw connection for conductor connection with 90° outlet direction, for use with and without mounting blocks.. The socket connectors provide space for labelling and can be coded. Packaged in cardboard box.

- 0.20 - 2,5 mm² (IEC) / 26 - 12 AWG (UL)
- 400 V (IEC) / 300 V (UL)
- 15 A (IEC) / 10 A (UL)

Derating curve

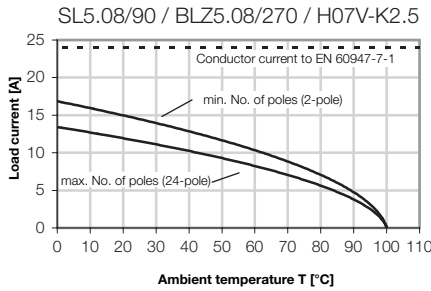

BLZ 5.08/90
BLZ 5.00/90

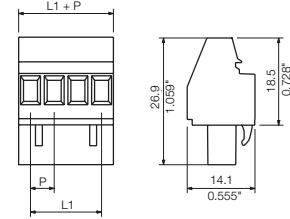

F

Technical data

SL5.08/90 / BLZ5.08/270 / H05V-K0.5

Rated data to IEC 60664-1 / IEC 61984			
Clamping range, max.	mm ²	0.13...3.31	
Solid H05(07) V-U	mm ²	0.2...2.5	
Stranded H07 V-R	mm ²		
Flexible H05(07) V-K	mm ²	0.2...2.5	
Flexible with ferrule	mm ²	0.2...2.5	
Ferrule with plastic collar	mm ²	0.2...2.5	
Stripping length	mm	7	
Screwdriver blade	mm	0.6 x 3.5	
according to norm		DIN 5264	
Tightening torque range	Nm	0.4...0.5	
Rated current at ambient temperature			
	A	20°C	40°C
		15	12
Overvoltage category			
		III	III
Pollution severity			
		3	2
		2	2
Rated voltage	V	250	320
Rated impulse voltage	kV	4	4
		4	4
UL 1059 rated data - E60693			
		B	C
		D	
Rated voltage	V	300	300
Rated current	A	10	10
AWG conductor		26-12	
CSA C22.2 rated data - LR12400			
		B	C
		D	
Rated voltage	V	300	300
Rated current	A	10	10
AWG conductor		26-12	
Material data			
Type of insulating material		PBT	
Flammability class acc. UL94		V-0	
Contact base material		Cu alloy	
Material of contact surface		tinned	

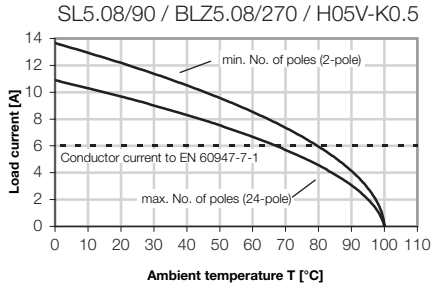

Ordering data

Solder pin length					
Colour					
<input type="checkbox"/> orange <input type="checkbox"/> black					
Pitch 5.08 mm					
Poles	L1 mm	(inch)	Qty.	Order No.	Order No.
2	5.08	(0.200)	100	1552760000	1552710000
3	10.16	(0.400)	100	1552860000	1552810000
4	15.24	(0.600)	100	1552960000	1552910000
5	20.32	(0.800)	50	1553060000	1553010000
6	25.40	(1.000)	50	1553160000	1553110000
7	30.48	(1.200)	50	1553260000	1553210000
8	35.56	(1.400)	50	1553360000	1553310000
9	40.64	(1.600)	50	1553460000	1553410000
10	45.72	(1.800)	50	1553560000	1553510000
11	50.80	(2.000)	50	1553660000	1553610000
12	55.88	(2.200)	50	1553760000	1553710000
13	60.96	(2.400)	50	1553860000	1553810000
14	66.04	(2.600)	50	1553960000	1553910000
15	71.12	(2.800)	50	1554060000	1554010000
16	76.20	(3.000)	50	1554160000	1554110000
17	81.28	(3.200)	20	1554260000	1554210000
18	86.36	(3.400)	20	1554360000	1554310000
19	91.44	(3.600)	20	1554460000	1554410000
20	96.52	(3.800)	20	1554560000	1554510000
21	101.60	(4.000)	20	1554660000	1554610000
22	106.68	(4.200)	20	1554760000	1554710000
23	111.76	(4.400)	20	1554860000	1554810000
24	116.84	(4.600)	20	1554960000	1554910000
Pitch 5.00 mm					
Poles	L1 mm	(inch)	Qty.	Order No.	Order No.
2	5.00	(0.197)	100	1635940000	1636890000
3	10.00	(0.394)	100	1635950000	1636900000
4	15.00	(0.591)	100	1635960000	1636910000
5	20.00	(0.787)	50	1635970000	1636920000
6	25.00	(0.984)	50	1635980000	1636930000
7	30.00	(1.181)	50	1635990000	1636940000
8	35.00	(1.378)	50	1636000000	1636950000
9	40.00	(1.575)	50	1636010000	1636960000
10	45.00	(1.772)	50	1636020000	1636970000
11	50.00	(1.969)	50	1636030000	1636980000
12	55.00	(2.165)	50	1636040000	1636990000
13	60.00	(2.362)	50	1636050000	1637000000
14	65.00	(2.559)	50	1636060000	1637010000
15	70.00	(2.756)	50	1636070000	1637020000
16	75.00	(2.953)	50	1636080000	1637030000
17	80.00	(3.150)	20	1636090000	1637040000
18	85.00	(3.346)	20	1636100000	1637050000
19	90.00	(3.543)	20	1636110000	1637060000
20	95.00	(3.740)	20	1636120000	1637070000
21	100.00	(3.937)	20	1636130000	1637080000
22	105.00	(4.134)	20	1636140000	1637090000
23	110.00	(4.331)	20	1636150000	1637100000
24	115.00	(4.528)	20	1636160000	1637110000

- Information**
- Additional colours on request
 - Gold-plated contact surfaces on request
 - Rated current related to rated cross-section and min. No. of poles.
 - Wire end ferrule without plastic collar to DIN 46228 pt 1
 - Wire end ferrule with plastic collar to DIN 46228 pt 4
 - P on drg. = pitch
 - Rated data refer only to the component itself. Clearance and creepage distances to other components are to be designed in accordance with the relevant application standards.

Socket connectors with clamping yoke connection

BLZ 5.08/270 BLZ 5.00/270

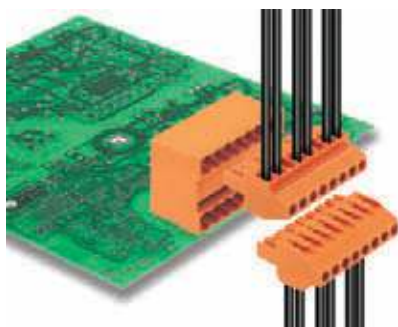

Socket connectors with clamping yoke screw connection, offering versions for use with and without mounting blocks, for conductor connection with 270° outlet direction. The socket connectors provide space for labelling and can be coded. Packaged in cardboard box.

- 0.20 - 2,5 mm² (IEC) / 26 - 12 AWG (UL)
- 400 V (IEC) / 300 V (UL)
- 15 A (IEC) / 10 A (UL)

Derating curve

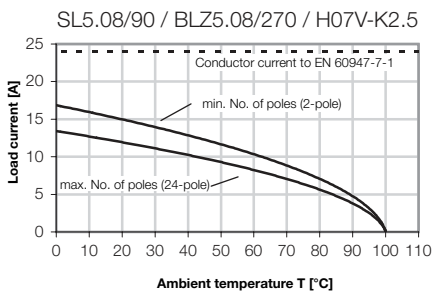

BLZ 5.08/270 BLZ 5.00/270

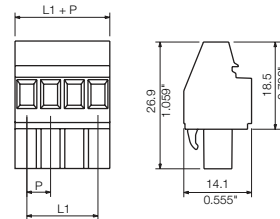

F

Technical data

Rated data to IEC 60664-1 / IEC 61984			
Clamping range, max.	mm ²	0.13...3.31	
Solid H05(07) V-U	mm ²	0.2...2.5	
Stranded H07 V-R	mm ²		
Flexible H05(07) V-K	mm ²	0.2...2.5	
Flexible with ferrule	mm ²	0.2...2.5	
Ferrule with plastic collar	mm ²	0.2...2.5	
Stripping length	mm	7	
Screwdriver blade	mm	0.6 x 3.5	
according to norm		DIN 5264	
Tightening torque range	Nm	0.4...0.5	
Rated current at ambient temperature			
	A	20°C	40°C
		15	12
Overvoltage category			
		III	III
Pollution severity			
		3	2
Rated voltage	V	250	320
Rated impulse voltage	kV	4	4
UL 1059 rated data - E60693			
		B	C
Rated voltage	V	300	300
Rated current	A	10	10
AWG conductor		26-12	
CSA C22.2 rated data - LR12400 B			
		B	C
Rated voltage	V	300	300
Rated current	A	10	10
AWG conductor		26-12	
Material data			
Type of insulating material		PBT	
Flammability class acc. UL94		V-0	
Contact base material		Cu alloy	
Material of contact surface		tinned	

- #### Information
- Additional colours on request
 - Gold-plated contact surfaces on request
 - Rated current related to rated cross-section and min. No. of poles.
 - Wire end ferrule without plastic collar to DIN 46228 pt 1
 - Wire end ferrule with plastic collar to DIN 46228 pt 4
 - P on drg. = pitch
 - Rated data refer only to the component itself. Clearance and creepage distances to other components are to be designed in accordance with the relevant application standards.

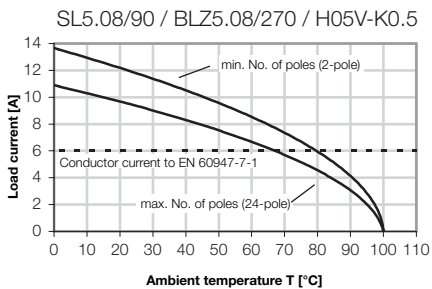

Ordering data

Solder pin length					
Colour		orange	black		
Pitch 5.08 mm					
Poles	L1 mm	(inch)	Qty.	Order No.	Order No.
2	5.08	(0.200)	100	1557360000	1557310000
3	10.16	(0.400)	100	1557460000	1557410000
4	15.24	(0.600)	100	1557560000	1557510000
5	20.32	(0.800)	50	1557660000	1557610000
6	25.40	(1.000)	50	1557760000	1557710000
7	30.48	(1.200)	50	1557860000	1557810000
8	35.56	(1.400)	50	1557960000	1557910000
9	40.64	(1.600)	50	1558060000	1558010000
10	45.72	(1.800)	50	1558160000	1558110000
11	50.80	(2.000)	50	1558260000	1558210000
12	55.88	(2.200)	50	1558360000	1558310000
13	60.96	(2.400)	50	1558460000	1558410000
14	66.04	(2.600)	50	1558560000	1558510000
15	71.12	(2.800)	50	1558660000	1558610000
16	76.20	(3.000)	50	1558760000	1558710000
17	81.28	(3.200)	20	1558860000	1558810000
18	86.36	(3.400)	20	1558960000	1558910000
19	91.44	(3.600)	20	1559060000	1559010000
20	96.52	(3.800)	20	1559160000	1559110000
21	101.60	(4.000)	20	1559260000	1559210000
22	106.68	(4.200)	20	1559360000	1559310000
23	111.76	(4.400)	20	1559460000	1559410000
24	116.84	(4.600)	20	1559560000	1559510000
Pitch 5.00 mm					
Poles	L1 mm	(inch)	Qty.	Order No.	Order No.
2	5.00	(0.197)	100	1637580000	1637810000
3	10.00	(0.394)	100	1637590000	1637820000
4	15.00	(0.591)	100	1637600000	1637830000
5	20.00	(0.787)	50	1637610000	1637840000
6	25.00	(0.984)	50	1637620000	1637850000
7	30.00	(1.181)	50	1637630000	1637860000
8	35.00	(1.378)	50	1637640000	1637870000
9	40.00	(1.575)	50	1637650000	1637880000
10	45.00	(1.772)	50	1637660000	1637890000
11	50.00	(1.969)	50	1637670000	1637900000
12	55.00	(2.165)	50	1637680000	1637910000
13	60.00	(2.362)	50	1637690000	1637920000
14	65.00	(2.559)	50	1637700000	1637930000
15	70.00	(2.756)	50	1637710000	1637940000
16	75.00	(2.953)	50	1637720000	1637950000
17	80.00	(3.150)	20	1637730000	1637960000
18	85.00	(3.346)	20	1637740000	1637970000
19	90.00	(3.543)	20	1637750000	1637980000
20	95.00	(3.740)	20	1637760000	1637990000
21	100.00	(3.937)	20	1637770000	1638000000
22	105.00	(4.134)	20	1637780000	1638010000
23	110.00	(4.331)	20	1637790000	1638020000
24	115.00	(4.528)	20	1637800000	1638030000

BLZ 5.08/270B
BLZ 5.00/270B

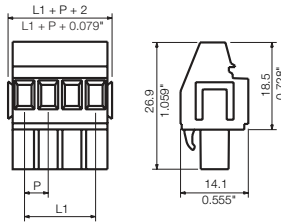

BLZ 5.08/270F
BLZ 5.00/270F

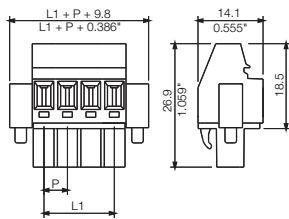

Accessories

Possible colors

Additional colours on request



Coding

See chapter accessories

Ordering data

Solder pin length

Colour	orange	black
--------	--------	-------

Pitch 5.08 mm

Poles	L1 mm	(inch)	Qty.	Order No.	Order No.
2	5.08	(0.200)	100	1559660000	1559610000
3	10.16	(0.400)	100	1559760000	1559710000
4	15.24	(0.600)	100	1559860000	1559810000
5	20.32	(0.800)	50	1559960000	1559910000
6	25.40	(1.000)	50	1560060000	1560010000
7	30.48	(1.200)	50	1560160000	1560110000
8	35.56	(1.400)	50	1560260000	1560210000
9	40.64	(1.600)	50	1560360000	1560310000
10	45.72	(1.800)	50	1560460000	1560410000
11	50.80	(2.000)	50	1560560000	1560510000
12	55.88	(2.200)	50	1560660000	1560610000
13	60.96	(2.400)	50	1560760000	1560710000
14	66.04	(2.600)	50	1560860000	1560810000
15	71.12	(2.800)	50	1560960000	1560910000
16	76.20	(3.000)	50	1561060000	1561010000
17	81.28	(3.200)	20	1561160000	1561110000
18	86.36	(3.400)	20	1561260000	1561210000
19	91.44	(3.600)	20	1561360000	1561310000
20	96.52	(3.800)	20	1561460000	1561410000
21	101.60	(4.000)	20	1561560000	1561510000
22	106.68	(4.200)	20	1561660000	1561610000
23	111.76	(4.400)	20	1561760000	1561710000
24	116.84	(4.600)	20	1561860000	1561810000

Pitch 5.00 mm

Poles	L1 mm	(inch)	Qty.	Order No.	Order No.
2	5.00	(0.197)	100	1638040000	1638270000
3	10.00	(0.394)	100	1638050000	1638280000
4	15.00	(0.591)	100	1638060000	1638290000
5	20.00	(0.787)	50	1638070000	1638300000
6	25.00	(0.984)	50	1638080000	1638310000
7	30.00	(1.181)	50	1638090000	1638320000
8	35.00	(1.378)	50	1638100000	1638330000
9	40.00	(1.575)	50	1638110000	1638340000
10	45.00	(1.772)	50	1638120000	1638350000
11	50.00	(1.969)	50	1638130000	1638360000
12	55.00	(2.165)	50	1638140000	1638370000
13	60.00	(2.362)	50	1638150000	1638380000
14	65.00	(2.559)	50	1638160000	1638390000
15	70.00	(2.756)	50	1638170000	1638400000
16	75.00	(2.953)	50	1638180000	1638410000
17	80.00	(3.150)	20	1638190000	1638420000
18	85.00	(3.346)	20	1638200000	1638430000
19	90.00	(3.543)	20	1638210000	1638440000
20	95.00	(3.740)	20	1638220000	1638450000
21	100.00	(3.937)	20	1638230000	1638460000
22	105.00	(4.134)	20	1638240000	1638470000
23	110.00	(4.331)	20	1638250000	1638480000
24	115.00	(4.528)	20	1638260000	1638490000

Ordering data

Solder pin length

Colour	orange	black
--------	--------	-------

Pitch 5.08 mm

Poles	L1 mm	(inch)	Qty.	Order No.	Order No.
2	5.08	(0.200)	100	1894390000	1894620000
3	10.16	(0.400)	100	1894400000	1894630000
4	15.24	(0.600)	100	1894410000	1894640000
5	20.32	(0.800)	50	1894420000	1894650000
6	25.40	(1.000)	50	1894430000	1894660000
7	30.48	(1.200)	50	1894440000	1894670000
8	35.56	(1.400)	50	1894450000	1894680000
9	40.64	(1.600)	50	1894460000	1894690000
10	45.72	(1.800)	50	1894470000	1894700000
11	50.80	(2.000)	50	1894480000	1894800000
12	55.88	(2.200)	50	1894490000	1894810000
13	60.96	(2.400)	50	1894500000	1894820000
14	66.04	(2.600)	50	1894510000	1894830000
15	71.12	(2.800)	50	1894520000	1894840000
16	76.20	(3.000)	50	1894530000	1894850000
17	81.28	(3.200)	20	1894540000	1894860000
18	86.36	(3.400)	20	1894550000	1894870000
19	91.44	(3.600)	20	1894560000	1894880000
20	96.52	(3.800)	20	1894570000	1894890000
21	101.60	(4.000)	20	1894580000	1894900000
22	106.68	(4.200)	20	1894590000	1894910000
23	111.76	(4.400)	20	1894600000	1894920000
24	116.84	(4.600)	20	1894610000	1894930000

Pitch 5.00 mm

Poles	L1 mm	(inch)	Qty.	Order No.	Order No.
2	5.00	(0.197)	100	1911080000	1910860000
3	10.00	(0.394)	100	1911090000	1910870000
4	15.00	(0.591)	100	1911100000	1910880000
5	20.00	(0.787)	50	1911110000	1910900000
6	25.00	(0.984)	50	1911120000	1910910000
7	30.00	(1.181)	50	1911130000	1910920000
8	35.00	(1.378)	50	1911140000	1910930000
9	40.00	(1.575)	50	1911150000	1910940000
10	45.00	(1.772)	50	1911160000	1910950000
11	50.00	(1.969)	50	1911170000	1910960000
12	55.00	(2.165)	50	1911180000	1910970000
13	60.00	(2.362)	50	1911190000	1910980000
14	65.00	(2.559)	50	1911200000	1910990000
15	70.00	(2.756)	50	1911210000	1911000000
16	75.00	(2.953)	50	1911220000	1911010000
17	80.00	(3.150)	20	1911230000	1911020000
18	85.00	(3.346)	20	1911240000	1911030000
19	90.00	(3.543)	20	1911250000	1911040000
20	95.00	(3.740)	20	1911260000	1911050000
21	100.00	(3.937)	20	1911270000	1911060000
22	105.00	(4.134)	20	1911280000	1911070000
23	110.00	(4.331)	20	1912000000	1911980000
24	115.00	(4.528)	20	1912010000	1911990000



Marking strips

See chapter accessories



Screwdriver

See chapter accessories
Order No. 9008390000



Socket connectors with clamping yoke connection

BLZ 5.08/270



Socket connectors with clamping yoke screw connection for conductor connection with 270° outlet direction and release lever (LH) or release bar (LR) mechanism. The socket connectors provide space for labelling and can be coded. Packaged in cardboard box.

- 0.20 - 2,5 mm² (IEC) / 26 - 12 AWG (UL)
- 400 V (IEC) / 300 V (UL)
- 15 A (IEC) / 10 A (UL)

Derating curve

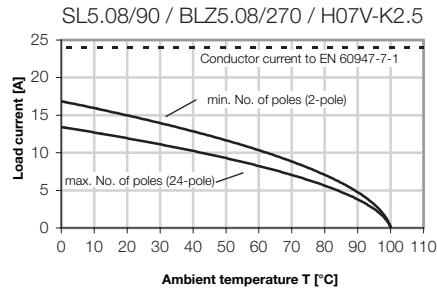

BLZ 5.08/270LH

with release lever

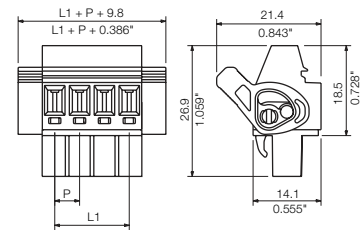

Technical data

Rated data to IEC 60664-1 / IEC 61984

Clamping range, max.	mm ²	0.13...3.31
Solid H05(07) V-U	mm ²	0.2...2.5
Stranded H07 V-R	mm ²	
Flexible H05(07) V-K	mm ²	0.2...2.5
Flexible with ferrule	mm ²	0.2...2.5
Ferrule with plastic collar	mm ²	0.2...2.5
Stripping length	mm	7
Screwdriver blade	mm	0.6 x 3.5
according to norm		DIN 5264
Tightening torque range	Nm	0.4...0.5

Rated current

at ambient temperature	20°C	40°C
A	15	12

Overvoltage category

III	III	II
-----	-----	----

Pollution severity

3	2	2
---	---	---

Rated voltage	V	250	320	400
Rated impulse voltage	kV	4	4	4

UL 1059 rated data - E60693

		B	C	D
--	--	----------	----------	----------

Rated voltage	V	300	300
Rated current	A	10	10
AWG conductor		26-12	

CSA C22.2 rated data - LR12400 B

		B	C	D
--	--	----------	----------	----------

Rated voltage	V	300	300
Rated current	A	10	10
AWG conductor		26-12	

Material data

Type of insulating material	PBT
Flammability class acc. UL94	V-0
Contact base material	Cu alloy
Material of contact surface	tinned

Information

- Additional colours on request
- Gold-plated contact surfaces on request
- Rated current related to rated cross-section and min. No. of poles.
- Wire end ferrule without plastic collar to DIN 46228 pt 1
- Wire end ferrule with plastic collar to DIN 46228 pt 4
- P on drg. = pitch
- Rated data refer only to the component itself. Clearance and creepage distances to other components are to be designed in accordance with the relevant application standards.

SL5.08/90 / BLZ5.08/270 / H05V-K0.5

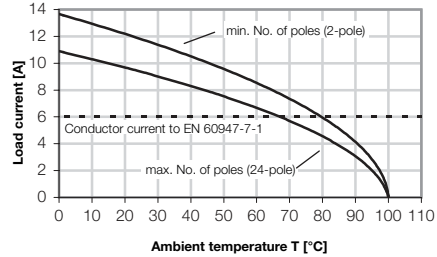

Ordering data

Solder pin length

Colour	orange	black
--------	---------------	--------------

Pitch 5.08 mm

Poles	L1 mm	(inch)	Qty.	Order No.	Order No.
15	71.12	(2.800)	50	1892400000	1894020000
16	76.20	(3.000)	50	1892410000	1894030000
17	81.28	(3.200)	20	1892420000	1894040000
18	86.36	(3.400)	20	1892430000	1894050000
19	91.44	(3.600)	20	1892440000	1894060000
20	96.52	(3.800)	20	1868940000	1896410000
21	101.60	(4.000)	20	1892450000	1894070000
22	106.68	(4.200)	20	1892460000	1894080000
23	111.76	(4.400)	20	1892470000	1894090000
24	116.84	(4.600)	20	1892480000	1894100000

BLZ 5.08/270LR

with release bar

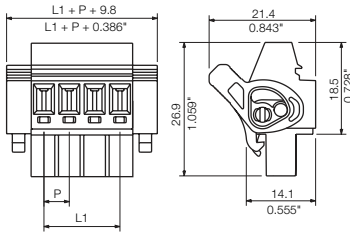

Ordering data

Solder pin length

Colour	<input checked="" type="checkbox"/> orange	<input type="checkbox"/> black
--------	--	--------------------------------

Pitch 5.08 mm

Poles	L1 mm	(inch)	Qty.	Order No.	Order No.
15	71.12	(2.800)	50	1893900000	1893810000
16	76.20	(3.000)	50	1893910000	1893820000
17	81.28	(3.200)	20	1893920000	1893830000
18	86.36	(3.400)	20	1893930000	1893840000
19	91.44	(3.600)	20	1893950000	1893850000
20	96.52	(3.800)	20	1868930000	1896420000
21	101.60	(4.000)	20	1893960000	1893860000
22	106.68	(4.200)	20	1893980000	1893870000
23	111.76	(4.400)	20	1894000000	1893880000
24	116.84	(4.600)	20	1894010000	1893890000

Accessories

Possible colors

Additional colours on request



Coding

See chapter accessories



Marking strips

See chapter accessories



Screwdriver

See chapter accessories
Order No. 9008390000



**LH release lever
LR release bar**

In confined space it is often difficult to gain access to and grab the plug-in connectors.

In order to be able to separate male and female connectors easily, Weidmüller has developed special connectors with a release lever. The release lever has to be braced against a surface in order to operate properly. This is achieved by using male connectors with a fixed flange, or devices with a suitably designed front panel. The lever can be operated either by hand or with a screwdriver.



plugged in



released

In addition to its release function, the release bar, in combination with the flange versions of the SL-SMT male connectors, also has a "locking" function. After the connector has been plugged in, the release bar is locked. Releasing this enables the plug-in connector to be easily separated again. The lever can be operated either by hand or with a screwdriver.



locked



released

Socket connectors with clamping yoke connection

BLZ 5.08/225

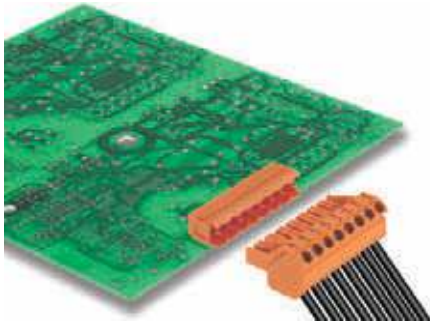

Socket connectors with clamping yoke screw connection for conductor connection with 225° outlet direction. The socket connectors provide space for labelling and can be coded. Packaged in cardboard box.

- 0.20 - 2,5 mm² (IEC) / 26 - 12 AWG (UL)
- 400 V (IEC) / 300 V (UL)
- 16.5 A (IEC) / 10 A (UL)

Derating curve

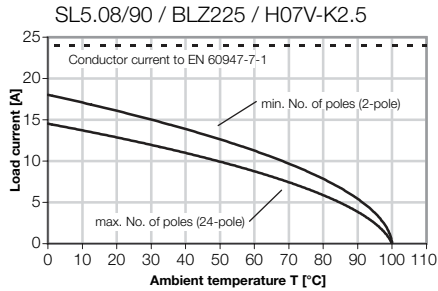

BLZ 5.08/225

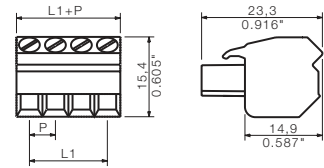

F

Technical data

Rated data to IEC 60664-1 / IEC 61984

Clamping range, max.	mm ²	0.13...3.31
Solid H05(07) V-U	mm ²	0.2...2.5
Stranded H07 V-R	mm ²	
Flexible H05(07) V-K	mm ²	0.2...2.5
Flexible with ferrule	mm ²	0.2...2.5
Ferrule with plastic collar	mm ²	0.2...1.5
Stripping length	mm	8
Screwdriver blade	mm	0.6 x 3.5
according to norm		DIN 5264
Tightening torque range	Nm	0.4...0.5

Rated current

at ambient temperature	20°C	40°C
A	16.5	14

Overvoltage category

	III	III	II
--	-----	-----	----

Pollution severity

	3	2	2
--	---	---	---

Rated voltage	V	250	320	400
Rated impulse voltage	kV	4	4	4

UL 1059 rated data - E60693

	B	C	D
Rated voltage	V	300	300
Rated current	A	10	10
AWG conductor		26-12	

CSA C22.2 rated data - LR12400 B

	B	C	D
Rated voltage	V	300	300
Rated current	A	10	10
AWG conductor		26-12	

Material data

Type of insulating material	PBT
Flammability class acc. UL94	V-0
Contact base material	Cu alloy
Material of contact surface	tinned

Information

- Additional colours on request
- Gold-plated contact surfaces on request
- Rated current related to rated cross-section and min. No. of poles.
- Wire end ferrule without plastic collar to DIN 46228 pt 1
- Wire end ferrule with plastic collar to DIN 46228 pt 4
- P on drg. = pitch
- Rated data refer only to the component itself. Clearance and creepage distances to other components are to be designed in accordance with the relevant application standards.

SL5.08/90 / BLZ225 / H05V-K0.5

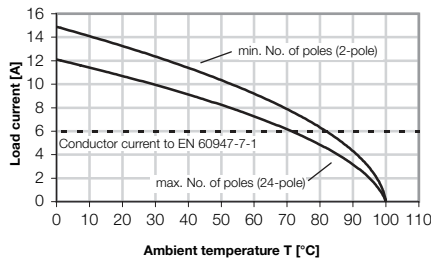

Ordering data

Solder pin length

Colour	orange	black
--------	--------	-------

Pitch 5.08 mm

Poles	L1 mm	(inch)	Qty.	Order No.	Order No.
2	5.08	(0.200)	100	1741640000	1741870000
3	10.16	(0.400)	100	1741650000	1741880000
4	15.24	(0.600)	100	1741660000	1741890000
5	20.32	(0.800)	50	1741670000	1741900000
6	25.40	(1.000)	50	1741680000	1741910000
7	30.48	(1.200)	50	1741690000	1741920000
8	35.56	(1.400)	50	1741700000	1741930000
9	40.64	(1.600)	50	1741710000	1741940000
10	45.72	(1.800)	50	1741720000	1741950000
11	50.80	(2.000)	50	1741730000	1741960000
12	55.88	(2.200)	50	1741740000	1741970000
13	60.96	(2.400)	50	1741750000	1741980000
14	66.04	(2.600)	50	1741760000	1741990000
15	71.12	(2.800)	50	1741770000	1742000000
16	76.20	(3.000)	50	1741780000	1742010000
17	81.28	(3.200)	20	1741790000	1742020000
18	86.36	(3.400)	20	1741800000	1742030000
19	91.44	(3.600)	20	1741810000	1742040000
20	96.52	(3.800)	20	1741820000	1742050000
21	101.60	(4.000)	20	1741830000	1742060000
22	106.68	(4.200)	20	1741840000	1742070000
23	111.76	(4.400)	20	1741850000	1742080000
24	116.84	(4.600)	20	1741860000	1742090000

BLZ 5.08/225B

Accessories

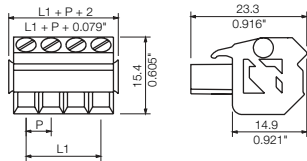

Possible colors

Additional colours on request



Coding

See chapter accessories

Ordering data

Solder pin length

Colour	<input checked="" type="checkbox"/> orange	<input type="checkbox"/> black
--------	--	--------------------------------

Pitch 5.08 mm

Poles	L1 mm	(inch)	Qty.	Order No.	Order No.
2	5.08	(0.200)	100	1742100000	1742330000
3	10.16	(0.400)	100	1742110000	1742340000
4	15.24	(0.600)	100	1742120000	1742350000
5	20.32	(0.800)	50	1742130000	1742360000
6	25.40	(1.000)	50	1742140000	1742370000
7	30.48	(1.200)	50	1742150000	1742380000
8	35.56	(1.400)	50	1742160000	1742390000
9	40.64	(1.600)	50	1742170000	1742400000
10	45.72	(1.800)	50	1742180000	1742410000
11	50.80	(2.000)	50	1742190000	1742420000
12	55.88	(2.200)	50	1742200000	1742430000
13	60.96	(2.400)	50	1742210000	1742440000
14	66.04	(2.600)	50	1742220000	1742450000
15	71.12	(2.800)	50	1742230000	1742460000
16	76.20	(3.000)	50	1742240000	1742470000
17	81.28	(3.200)	20	1742250000	1742480000
18	86.36	(3.400)	20	1742260000	1742490000
19	91.44	(3.600)	20	1742270000	1742500000
20	96.52	(3.800)	20	1742280000	1742510000
21	101.60	(4.000)	20	1742290000	1742520000
22	106.68	(4.200)	20	1742300000	1742530000
23	111.76	(4.400)	20	1742310000	1742540000
24	116.84	(4.600)	20	1742320000	1742550000



Fixing block

See chapter accessories



Marking strips

See chapter accessories



Screwdriver

See chapter accessories
Order No. 9008390000



BLDT 5.08

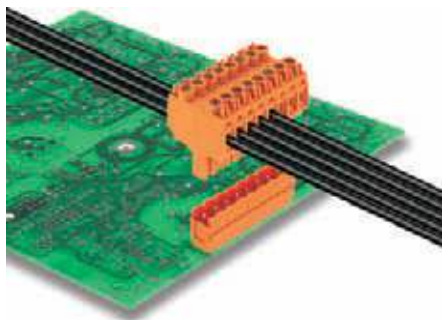

Socket connectors with 2 screw connections per pole for conductor connection with 90° and 270° outlet direction. The socket connectors provide space for labelling and can be coded. Packaged in cardboard box.

- 0.20 - 2,5 mm² (IEC) / 26 - 12 AWG (UL)
- 400 V (IEC) / 300 V (UL)
- 14 A (IEC) / 10 A (UL)

Derating curve

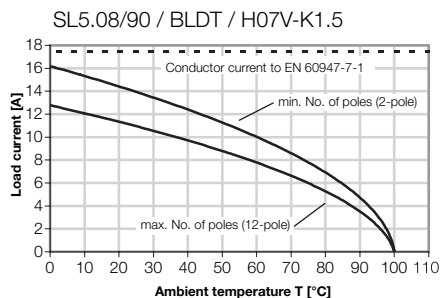

BLDT 5.08

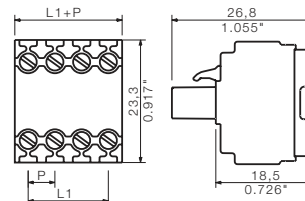

F

Technical data

Rated data to IEC 60664-1 / IEC 61984			
Clamping range, max.	mm ²	0.13...3.31	
Solid H05(07) V-U	mm ²	0.2...2.5	
Stranded H07 V-R	mm ²		
Flexible H05(07) V-K	mm ²	0.2...2.5	
Flexible with ferrule	mm ²	0.2...1.5	
Ferrule with plastic collar	mm ²	0.2...1.5	
Stripping length	mm	7	
Screwdriver blade	mm	0.6 x 3.5	
according to norm		DIN 5264	
Tightening torque range	Nm	0.4...0.5	
Rated current at ambient temperature			
	A	20°C	40°C
		14	12
Overvoltage category			
		III	III
Pollution severity			
		3	2
Rated voltage	V	250	320
Rated impulse voltage	kV	4	4
UL 1059 rated data - E60693			
		B	C
Rated voltage	V	300	300
Rated current	A	10	10
AWG conductor		26-12	
CSA C22.2 rated data - LR12400 B			
		B	C
Rated voltage	V	300	300
Rated current	A	10	10
AWG conductor		26-12	
Material data			
Type of insulating material		PBT	
Flammability class acc. UL94		V-0	
Contact base material		Cu alloy	
Material of contact surface		tinned	
Information			

- Additional colours on request
- Gold-plated contact surfaces on request
- Rated current related to rated cross-section and min. No. of poles.
- Wire end ferrule without plastic collar to DIN 46228 pt 1
- Wire end ferrule with plastic collar to DIN 46228 pt 4
- P on drg. = pitch
- Rated data refer only to the component itself. Clearance and creepage distances to other components are to be designed in accordance with the relevant application standards.

SL5.08/90 / BLDT / H05V-K0.5

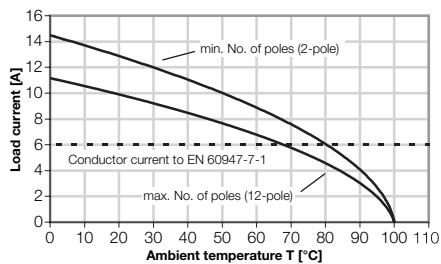

Ordering data

Solder pin length					
Colour		orange	black		
Pitch 5.08 mm					
Poles	L1 mm	(inch)	Qty.	Order No.	Order No.
2	5.08	(0.200)	100	1644730000	1660710000
3	10.16	(0.400)	100	1644740000	1660720000
4	15.24	(0.600)	50	1644750000	1660730000
5	20.32	(0.800)	50	1644760000	1660740000
6	25.40	(1.000)	50	1644770000	1660750000
7	30.48	(1.200)	50	1644780000	1660760000
8	35.56	(1.400)	50	1644790000	1660770000
9	40.64	(1.600)	50	1644800000	1660780000
10	45.72	(1.800)	50	1644810000	1660790000
11	50.80	(2.000)	50	1644820000	1660800000
12	55.88	(2.200)	50	1644830000	1660810000

BLDT 5.08B

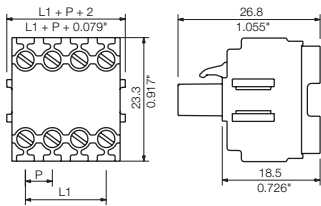

Accessories

Possible colors

Additional colours on request



Coding

See chapter accessories



Fixing block

See chapter accessories



Marking strips

See chapter accessories



Screwdriver

See chapter accessories
Order No. 9008390000



Ordering data

Solder pin length

Colour	<input checked="" type="checkbox"/> orange	<input type="checkbox"/> black
--------	--	--------------------------------

Pitch 5.08 mm

Poles	L1 mm	(inch)	Qty.	Order No.	Order No.
2	5.08	(0.200)	100	1651740000	1673780000
3	10.16	(0.400)	100	1651750000	1673790000
4	15.24	(0.600)	50	1651760000	1673800000
5	20.32	(0.800)	50	1651770000	1673810000
6	25.40	(1.000)	50	1651780000	1673820000
7	30.48	(1.200)	50	1651790000	1673830000
8	35.56	(1.400)	50	1651800000	1673840000
9	40.64	(1.600)	50	1651810000	1673850000
10	45.72	(1.800)	50	1651820000	1673860000
11	50.80	(2.000)	50	1651830000	1673870000
12	55.88	(2.200)	50	1651840000	1673880000

Socket connectors with TOP connection

BLT 5.08

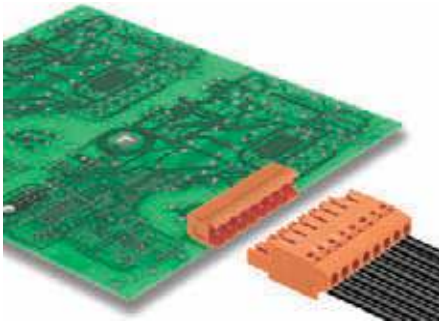

Socket connectors with screw connection in TOP system for conductor connection with straight 180° outlet direction. The socket connectors provide space for labelling and can be coded. Packaged in cardboard box.

- 0.20 - 2,5 mm² (IEC) / 26 - 14 AWG (UL)
- 400 V (IEC) / 300 V (UL)
- 17 A (IEC) / 10 A (UL)

Derating curve

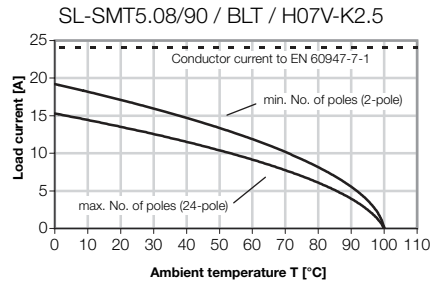

BLT 5.08

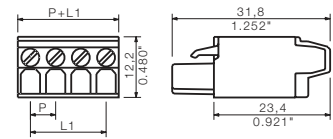

F

Technical data

Rated data to IEC 60664-1 / IEC 61984

Clamping range, max.	mm ²	0.13...2.5	
Solid H05(07) V-U	mm ²	0.2...2.5	
Stranded H07 V-R	mm ²		
Flexible H05(07) V-K	mm ²	0.2...1.5	
Flexible with ferrule	mm ²	0.2...1.5	
Ferrule with plastic collar	mm ²	0.2...1.5	
Stripping length	mm	13	
Screwdriver blade	mm	0.6 x 3.5	
according to norm		DIN 5264	
Tightening torque range	Nm	0.4...0.5	

Rated current

at ambient temperature		20°C	40°C
	A	17	15

Overvoltage category

	III	III	II
--	-----	-----	----

Pollution severity

	3	2	2
--	---	---	---

Rated voltage	V	250	320	400
Rated impulse voltage	kV	4	4	4

UL 1059 rated data - E60693

		B	C	D
Rated voltage	V	300	300	
Rated current	A	10	10	
AWG conductor		26-14		

CSA C22.2 rated data - LR12400 B

		B	C	D
Rated voltage	V	300	300	
Rated current	A	10	10	
AWG conductor		26-14		

Material data

Type of insulating material	PBT
Flammability class acc. UL94	V-0
Contact base material	CuSn
Material of contact surface	tinned

Information

- Additional colours on request
- Gold-plated contact surfaces on request
- Rated current related to rated cross-section and min. No. of poles.
- Wire end ferrule without plastic collar to DIN 46228 pt 1
- Wire end ferrule with plastic collar to DIN 46228 pt 4
- Crimp form A for wire end ferrules with PZ 6/5 crimping tool are recommended for the largest cable sizes.
- P on drg. = pitch
- Rated data refer only to the component itself. Clearance and creepage distances to other components are to be designed in accordance with the relevant application standards.

Derating curve

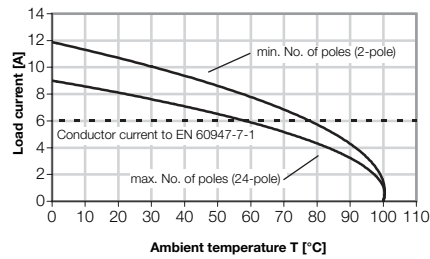

Ordering data

Solder pin length

Colour	<input checked="" type="checkbox"/> orange	<input type="checkbox"/> black
--------	--	--------------------------------

Pitch 5.08 mm

Poles	L1 mm	(inch)	Qty.	Order No.	Order No.
2	5.08	(0.200)	100	1499560000	1499510000
3	10.16	(0.400)	100	1499660000	1499610000
4	15.24	(0.600)	100	1499760000	1499710000
5	20.32	(0.800)	50	1499860000	1499810000
6	25.40	(1.000)	50	1499960000	1499910000
7	30.48	(1.200)	50	1500060000	1500010000
8	35.56	(1.400)	50	1500160000	1500110000
9	40.64	(1.600)	50	1500260000	1500210000
10	45.72	(1.800)	50	1500360000	1500310000
11	50.80	(2.000)	50	1500460000	1500410000
12	55.88	(2.200)	50	1500560000	1500510000
13	60.96	(2.400)	50	1500660000	1500610000
14	66.04	(2.600)	50	1500760000	1500710000
15	71.12	(2.800)	50	1500860000	1500810000
16	76.20	(3.000)	50	1500960000	1500910000
17	81.28	(3.200)	20	1501060000	1501010000
18	86.36	(3.400)	20	1501160000	1501110000
19	91.44	(3.600)	20	1501260000	1501210000
20	96.52	(3.800)	20	1501360000	1501310000
21	101.60	(4.000)	20	1501460000	1501410000
22	106.68	(4.200)	20	1501560000	1501510000
23	111.76	(4.400)	20	1501660000	1501610000
24	116.84	(4.600)	20	1501760000	1501710000

BLT 5.08LR

with release bar

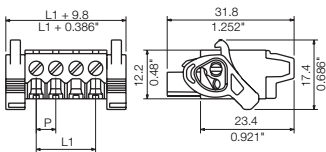

Ordering data

Solder pin length

Colour orange black

Pitch 5.08 mm

Poles	L1 mm	(inch)	Qty.	Order No.	Order No.
2	5.08	(0.200)	100	1890220000	1894130000
3	10.16	(0.400)	100	1890230000	1894140000
4	15.24	(0.600)	100	1890240000	1894150000
5	20.32	(0.800)	50	1890250000	1894160000
6	25.40	(1.000)	50	1890260000	1894170000
7	30.48	(1.200)	50	1890270000	1894180000
8	35.56	(1.400)	50	1890280000	1894190000
9	40.64	(1.600)	50	1890290000	1894200000
10	45.72	(1.800)	50	1890300000	1894210000
11	50.80	(2.000)	50	1890310000	1894220000
12	55.88	(2.200)	50	1890320000	1894230000
13	60.96	(2.400)	50	1890330000	1894240000
14	66.04	(2.600)	50	1890340000	1894250000
15	71.12	(2.800)	50	1890350000	1894260000
16	76.20	(3.000)	50	1890360000	1894270000
17	81.28	(3.200)	20	1890370000	1894280000
18	86.36	(3.400)	20	1890380000	1894290000
19	91.44	(3.600)	20	1890390000	1894310000
20	96.52	(3.800)	20	1890400000	1894330000
21	101.60	(4.000)	20	1890410000	1894340000
22	106.68	(4.200)	20	1890420000	1894350000
23	111.76	(4.400)	20	1890430000	1894360000
24	116.84	(4.600)	20	1890440000	1894370000

Accessories

Possible colors

Additional colours on request



Coding

See chapter accessories



Marking strips

See chapter accessories



Screwdriver

See chapter accessories
Order No. 9008390000



**LH release lever
LR release bar**

In confined space it is often difficult to gain access to and grab the plug-in connectors.

In order to be able to separate male and female connectors easily, Weidmüller has developed special connectors with a release lever. The release lever has to be braced against a surface in order to operate properly. This is achieved by using male connectors with a fixed flange, or devices with a suitably designed front panel. The lever can be operated either by hand or with a screwdriver.



plugged in



released

In addition to its release function, the release bar, in combination with the flange versions of the SL-SMT male connectors, also has a "locking" function. After the connector has been plugged in, the release bar is locked. Releasing this enables the plug-in connector to be easily separated again. The lever can be operated either by hand or with a screwdriver.



locked



released

F

Accessories

Coding

See chapter accessories



Clip-in lugs

See chapter accessories



Accessories

Possible colors

Additional colours on request



Coding

See chapter accessories



Marking strips

See chapter accessories



Screwdriver

See chapter accessories
Order No. 9008390000



BLZF 5.08/180B

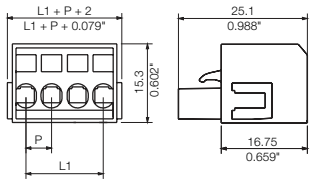

BLZF 5.08/180F

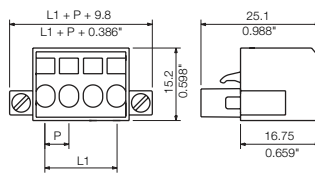

Accessories

Possible colors

Additional colours on request



Coding

See chapter accessories



Marking strips

See chapter accessories



Screwdriver

See chapter accessories
Order No. 9008390000



Ordering data

Solder pin length

Colour orange black

Pitch 5.08 mm

Poles	L1 mm	(inch)	Qty.	Order No.	Order No.
2	5.08	(0.200)	100	1708300000	1708530000
3	10.16	(0.400)	100	1708310000	1708540000
4	15.24	(0.600)	100	1708320000	1708550000
5	20.32	(0.800)	50	1708330000	1708560000
6	25.40	(1.000)	50	1708340000	1708570000
7	30.48	(1.200)	50	1708350000	1708580000
8	35.56	(1.400)	50	1708360000	1708590000
9	40.64	(1.600)	50	1708370000	1708600000
10	45.72	(1.800)	50	1708380000	1708610000
11	50.80	(2.000)	50	1708390000	1708620000
12	55.88	(2.200)	50	1708400000	1708630000
13	60.96	(2.400)	50	1708410000	1708640000
14	66.04	(2.600)	50	1708420000	1708650000
15	71.12	(2.800)	50	1708430000	1708660000
16	76.20	(3.000)	50	1708440000	1708670000
17	81.28	(3.200)	20	1708450000	1708680000
18	86.36	(3.400)	20	1708460000	1708690000
19	91.44	(3.600)	20	1708470000	1708700000
20	96.52	(3.800)	20	1708480000	1708710000
21	101.60	(4.000)	20	1708490000	1708720000
22	106.68	(4.200)	20	1708500000	1708730000
23	111.76	(4.400)	20	1708510000	1708740000
24	116.84	(4.600)	20	1708520000	1708750000

Ordering data

Solder pin length

Colour orange black

Pitch 5.08 mm

Poles	L1 mm	(inch)	Qty.	Order No.	Order No.
2	5.08	(0.200)	100	1803330000	1803560000
3	10.16	(0.400)	100	1803340000	1803570000
4	15.24	(0.600)	100	1803350000	1803580000
5	20.32	(0.800)	50	1803360000	1803590000
6	25.40	(1.000)	50	1803370000	1803600000
7	30.48	(1.200)	50	1803380000	1803610000
8	35.56	(1.400)	50	1803390000	1803620000
9	40.64	(1.600)	50	1803400000	1803630000
10	45.72	(1.800)	50	1803410000	1803640000
11	50.80	(2.000)	50	1803420000	1803650000
12	55.88	(2.200)	50	1803430000	1803660000
13	60.96	(2.400)	50	1803440000	1803670000
14	66.04	(2.600)	50	1803450000	1803680000
15	71.12	(2.800)	50	1803460000	1803690000
16	76.20	(3.000)	50	1803470000	1803700000
17	81.28	(3.200)	20	1803480000	1803710000
18	86.36	(3.400)	20	1803490000	1803720000
19	91.44	(3.600)	20	1803500000	1803730000
20	96.52	(3.800)	20	1803510000	1803740000
21	101.60	(4.000)	20	1803520000	1803750000
22	106.68	(4.200)	20	1803530000	1803760000
23	111.76	(4.400)	20	1803540000	1803770000
24	116.84	(4.600)	20	1803550000	1803780000

Socket connectors with tension clamp connection

BLZF 5.08/180



Socket connectors for conductor connection in tension clamp system with straight 180° outlet direction and release lever (LH) or release bar (LR) mechanism. The socket connectors provide space for labelling and can be coded. Packaged in cardboard box.

- 0.20 - 2,5 mm² (IEC) / 26 - 12 AWG (UL)
- 400 V (IEC) / 300 V (UL)
- 17 A (IEC) / 15 A (UL)

Derating curve

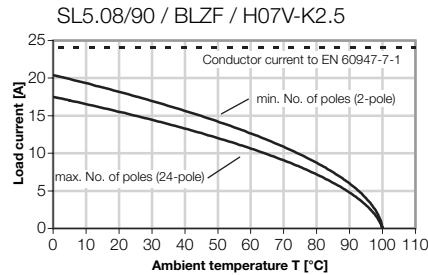

BLZF 5.08/180LH

with release lever

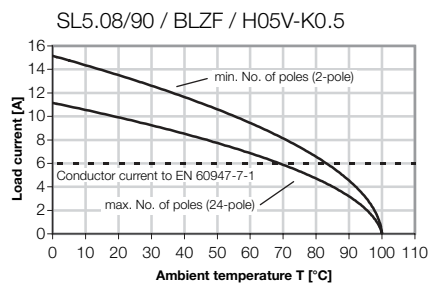
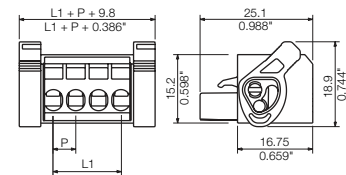

Ordering data

Solder pin length		Colour	
		orange	black
Pitch 5.08 mm			
Poles	L1 mm (inch)	Qty.	Order No.
2	5.08 (0.200)	100	1895720000
3	10.16 (0.400)	100	1895730000
4	15.24 (0.600)	100	1895740000
5	20.32 (0.800)	50	1895750000
6	25.40 (1.000)	50	1895760000
7	30.48 (1.200)	50	1895770000
8	35.56 (1.400)	50	1895780000
9	40.64 (1.600)	50	1895790000
10	45.72 (1.800)	50	1895800000
11	50.80 (2.000)	50	1895810000
12	55.88 (2.200)	50	1895820000
13	60.96 (2.400)	50	1895830000
14	66.04 (2.600)	50	1895840000
15	71.12 (2.800)	50	1895850000
16	76.20 (3.000)	50	1895860000
17	81.28 (3.200)	20	1895870000
18	86.36 (3.400)	20	1895880000
19	91.44 (3.600)	20	1895890000
20	96.52 (3.800)	20	1895900000
21	101.60 (4.000)	20	1895910000
22	106.68 (4.200)	20	1895920000
23	111.76 (4.400)	20	1895930000
24	116.84 (4.600)	20	1895940000

Technical data

Rated data to IEC 60664-1 / IEC 61984		
Clamping range, max.	mm ²	0.13...3.31
Solid H05(07) V-U	mm ²	0.2...2.5
Stranded H07 V-R	mm ²	
Flexible H05(07) V-K	mm ²	0.2...2.5
Flexible with ferrule	mm ²	0.2...1.5
Ferrule with plastic collar	mm ²	0.2...1.5
Stripping length	mm	10
Screwdriver blade	mm	0.6 x 3.5
according to norm		DIN 5264-A
Tightening torque range	Nm	
Rated current at ambient temperature		
	A	20°C 40°C
		17 14.5
Overvoltage category		
		III III II
Pollution severity		
		3 2 2
Rated voltage	V	250 320 400
Rated impulse voltage	kV	4 4 4
UL 1059 rated data - E60693		
		B C D
Rated voltage	V	300 300
Rated current	A	15 10
AWG conductor		26-12
CSA C22.2 rated data - LR12400 B		
		B C D
Rated voltage	V	300 300
Rated current	A	15 10
AWG conductor		26-12
Material data		
Type of insulating material		PBT
Flammability class acc. UL94		V-0
Contact base material		Cu alloy
Material of contact surface		tinned

- Information**
- Additional colours on request
 - Gold-plated contact surfaces on request
 - Rated current related to rated cross-section and min. No. of poles.
 - Wire end ferrule without plastic collar to DIN 46228 pt 1
 - Wire end ferrule with plastic collar to DIN 46228 pt 4
 - P on drg. = pitch
 - Rated data refer only to the component itself. Clearance and creepage distances to other components are to be designed in accordance with the relevant application standards.

BLZF 5.08/180LR

with release bar

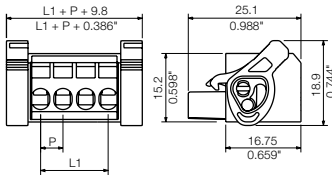

Ordering data

Solder pin length

Colour	<input checked="" type="checkbox"/> orange	<input type="checkbox"/> black
--------	--	--------------------------------

Pitch 5.08 mm

Poles	L1 mm	(inch)	Qty.	Order No.	Order No.
2	5.08	(0.200)	100	1851410000	1892720000
3	10.16	(0.400)	100	1851420000	1892730000
4	15.24	(0.600)	100	1851430000	1892740000
5	20.32	(0.800)	50	1851440000	1892750000
6	25.40	(1.000)	50	1851450000	1892760000
7	30.48	(1.200)	50	1851460000	1892770000
8	35.56	(1.400)	50	1851470000	1892780000
9	40.64	(1.600)	50	1851480000	1892790000
10	45.72	(1.800)	50	1851490000	1892800000
11	50.80	(2.000)	50	1851510000	1892810000
12	55.88	(2.200)	50	1851520000	1892820000
13	60.96	(2.400)	50	1851530000	1892830000
14	66.04	(2.600)	50	1851550000	1892840000
15	71.12	(2.800)	50	1851560000	1892850000
16	76.20	(3.000)	50	1851580000	1892860000
17	81.28	(3.200)	20	1851600000	1892870000
18	86.36	(3.400)	20	1851610000	1892880000
19	91.44	(3.600)	20	1851620000	1892890000
20	96.52	(3.800)	20	1851630000	1892900000
21	101.60	(4.000)	20	1851640000	1892910000
22	106.68	(4.200)	20	1851650000	1892920000
23	111.76	(4.400)	20	1851660000	1892930000
24	116.84	(4.600)	20	1851670000	1892940000

Accessories

Possible colors

Additional colours on request



Coding

See chapter accessories



Marking strips

See chapter accessories



Screwdriver

See chapter accessories
Order No. 9008390000



**LH release lever
LR release bar**

In confined space it is often difficult to gain access to and grab the plug-in connectors.

In order to be able to separate male and female connectors easily, Weidmüller has developed special connectors with a release lever. The release lever has to be braced against a surface in order to operate properly. This is achieved by using male connectors with a fixed flange, or devices with a suitably designed front panel. The lever can be operated either by hand or with a screwdriver.



plugged in



released

In addition to its release function, the release bar, in combination with the flange versions of the SL-SMT male connectors, also has a "locking" function. After the connector has been plugged in, the release bar is locked. Releasing this enables the plug-in connector to be easily separated again. The lever can be operated either by hand or with a screwdriver.



locked



released

BLZF 5.08/90

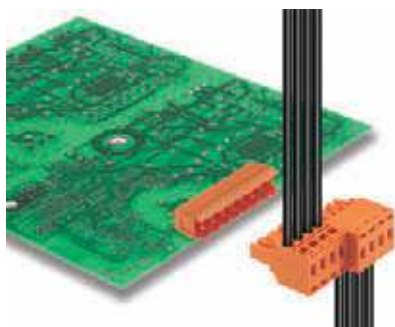

Socket connectors for conductor connection in tension clamp system with 90° outlet direction. The socket connectors provide space for labelling and can be coded. Packaged in cardboard box.

- 0.20 - 2,5 mm² (IEC) / 26 - 12 AWG (UL)
- 400 V (IEC) / 300 V (UL)
- 16,5 A (IEC) / 10 A (UL)

Derating curve

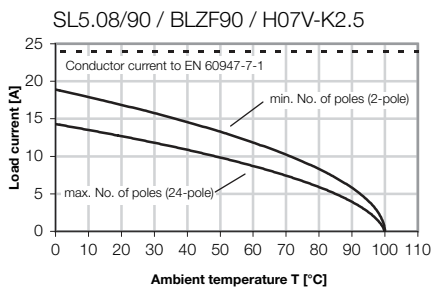

BLZF 5.08/90

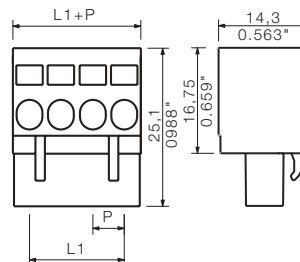

F

Technical data

Rated data to IEC 60664-1 / IEC 61984			
Clamping range, max.	mm ²	0.13...3.31	
Solid H05(07) V-U	mm ²	0.2...2.5	
Stranded H07 V-R	mm ²		
Flexible H05(07) V-K	mm ²	0.2...2.5	
Flexible with ferrule	mm ²	0.2...1.5	
Ferrule with plastic collar	mm ²	0.2...1.5	
Stripping length	mm	10	
Screwdriver blade	mm	0.6 x 3.5	
according to norm		DIN 5264-A	
Tightening torque range	Nm		
Rated current at ambient temperature			
	A	20°C	40°C
		16.5	14
Overvoltage category			
		III	III
Pollution severity			
		3	2
		2	2
Rated voltage	V	250	320
Rated impulse voltage	kV	4	4
		4	4
UL 1059 rated data - E60693			
		B	C
Rated voltage	V	300	300
Rated current	A	10	10
AWG conductor		26-12	
CSA C22.2 rated data - LR12400 B			
		B	C
Rated voltage	V	300	300
Rated current	A	10	10
AWG conductor		26-12	
Material data			
Type of insulating material		PBT	
Flammability class acc. UL94		V-0	
Contact base material		Cu alloy	
Material of contact surface		tinned	
Information			

- Additional colours on request
- Gold-plated contact surfaces on request
- Rated current related to rated cross-section and min. No. of poles.
- Wire end ferrule without plastic collar to DIN 46228 pt 1
- Wire end ferrule with plastic collar to DIN 46228 pt 4
- P on drg. = pitch
- Rated data refer only to the component itself. Clearance and creepage distances to other components are to be designed in accordance with the relevant application standards.

Ordering data

Solder pin length					
Colour		orange	black		
Pitch 5.08 mm					
Poles	L1 mm	(inch)	Qty.	Order No.	Order No.
2	5.08	(0.200)	100	1670790000	1671020000
3	10.16	(0.400)	100	1670800000	1671030000
4	15.24	(0.600)	100	1670810000	1671040000
5	20.32	(0.800)	50	1670820000	1671050000
6	25.40	(1.000)	50	1670830000	1671060000
7	30.48	(1.200)	50	1670840000	1671070000
8	35.56	(1.400)	50	1670850000	1671080000
9	40.64	(1.600)	50	1670860000	1671090000
10	45.72	(1.800)	50	1670870000	1671100000
11	50.80	(2.000)	50	1670880000	1671110000
12	55.88	(2.200)	50	1670890000	1671120000
13	60.96	(2.400)	50	1670900000	1671130000
14	66.04	(2.600)	50	1670910000	1671140000
15	71.12	(2.800)	50	1670920000	1671150000
16	76.20	(3.000)	50	1670930000	1671160000
17	81.28	(3.200)	20	1670940000	1671170000
18	86.36	(3.400)	20	1670950000	1671180000
19	91.44	(3.600)	20	1670960000	1671190000
20	96.52	(3.800)	20	1670970000	1671200000
21	101.60	(4.000)	20	1670980000	1671210000
22	106.68	(4.200)	20	1670990000	1671220000
23	111.76	(4.400)	20	1671000000	1671230000
24	116.84	(4.600)	20	1671010000	1671240000

BLZF 5.08/90B

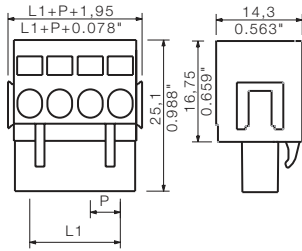

Accessories

Possible colors

Additional colours on request



Coding

See chapter accessories

Ordering data

Solder pin length

Colour	<input checked="" type="checkbox"/> orange	<input type="checkbox"/> black
--------	--	--------------------------------

Pitch 5.08 mm

Poles	L1 mm	(inch)	Qty.	Order No.	Order No.
2	5.08	(0.200)	100	1671250000	1671480000
3	10.16	(0.400)	100	1671260000	1671490000
4	15.24	(0.600)	100	1671270000	1671500000
5	20.32	(0.800)	50	1671280000	1671510000
6	25.40	(1.000)	50	1671290000	1671520000
7	30.48	(1.200)	50	1671300000	1671530000
8	35.56	(1.400)	50	1671310000	1671540000
9	40.64	(1.600)	50	1671320000	1671550000
10	45.72	(1.800)	50	1671330000	1671560000
11	50.80	(2.000)	50	1671340000	1671570000
12	55.88	(2.200)	50	1671350000	1671580000
13	60.96	(2.400)	50	1671360000	1671590000
14	66.04	(2.600)	50	1671370000	1671600000
15	71.12	(2.800)	50	1671380000	1671610000
16	76.20	(3.000)	50	1671390000	1671620000
17	81.28	(3.200)	20	1671400000	1671630000
18	86.36	(3.400)	20	1671410000	1671640000
19	91.44	(3.600)	20	1671420000	1671650000
20	96.52	(3.800)	20	1671430000	1671660000
21	101.60	(4.000)	20	1671440000	1671670000
22	106.68	(4.200)	20	1671450000	1671680000
23	111.76	(4.400)	20	1671460000	1671690000
24	116.84	(4.600)	20	1671470000	1671700000



Fixing block

See chapter accessories



Marking strips

See chapter accessories



Screwdriver

See chapter accessories
Order No. 9008390000



BLZF 5.08/270

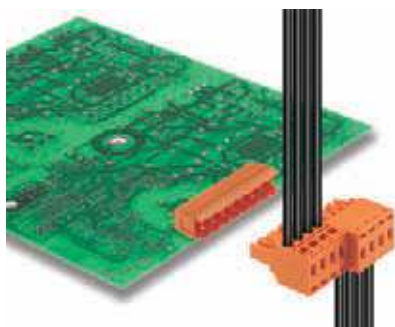

Socket connectors for conductor connection in tension clamp system with 270° outlet direction. The socket connectors provide space for labelling and can be coded. Packaged in cardboard box.

- 0.20 - 2,5 mm² (IEC) / 26 - 12 AWG (UL)
- 400 V (IEC) / 300 V (UL)
- 16,5 A (IEC) / 10 A (UL)

Derating curve

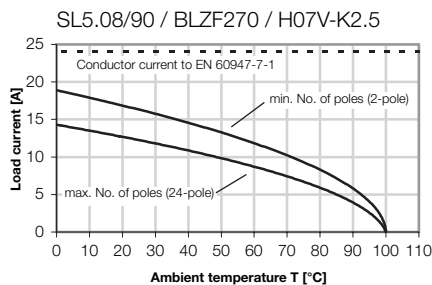

BLZF 5.08/270

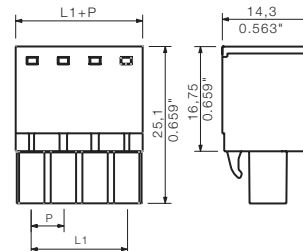

F

Technical data

Rated data to IEC 60664-1 / IEC 61984			
Clamping range, max.	mm ²	0.13...3.31	
Solid H05(07) V-U	mm ²	0.2...2.5	
Stranded H07 V-R	mm ²		
Flexible H05(07) V-K	mm ²	0.2...2.5	
Flexible with ferrule	mm ²	0.2...1.5	
Ferrule with plastic collar	mm ²	0.2...1.5	
Stripping length	mm	10	
Screwdriver blade	mm	0.6 x 3.5	
according to norm		DIN 5264-A	
Tightening torque range	Nm		
Rated current at ambient temperature			
	A	20°C	40°C
		16.5	14
Overvoltage category			
		III	III
Pollution severity			
		3	2
		2	2
Rated voltage	V	250	320
Rated impulse voltage	kV	4	4
		4	4
UL 1059 rated data - E60693			
		B	C
Rated voltage	V	300	300
Rated current	A	10	10
AWG conductor		26-12	
CSA C22.2 rated data - LR12400 B			
		B	C
Rated voltage	V	300	300
Rated current	A	10	10
AWG conductor		26-12	
Material data			
Type of insulating material		PBT	
Flammability class acc. UL94		V-0	
Contact base material		Cu alloy	
Material of contact surface		tinned	
Information			

- Additional colours on request
- Gold-plated contact surfaces on request
- Rated current related to rated cross-section and min. No. of poles.
- Wire end ferrule without plastic collar to DIN 46228 pt 1
- Wire end ferrule with plastic collar to DIN 46228 pt 4
- P on drg. = pitch
- Rated data refer only to the component itself. Clearance and creepage distances to other components are to be designed in accordance with the relevant application standards.

Ordering data

Solder pin length					
Colour		orange	black		
Pitch 5.08 mm					
Poles	L1 mm	(inch)	Qty.	Order No.	Order No.
2	5.08	(0.200)	100	1671940000	1672170000
3	10.16	(0.400)	100	1671950000	1672180000
4	15.24	(0.600)	100	1671960000	1672190000
5	20.32	(0.800)	50	1671970000	1672200000
6	25.40	(1.000)	50	1671980000	1672210000
7	30.48	(1.200)	50	1671990000	1672220000
8	35.56	(1.400)	50	1672000000	1672230000
9	40.64	(1.600)	50	1672010000	1672240000
10	45.72	(1.800)	50	1672020000	1672250000
11	50.80	(2.000)	50	1672030000	1672260000
12	55.88	(2.200)	50	1672040000	1672270000
13	60.96	(2.400)	50	1672050000	1672280000
14	66.04	(2.600)	50	1672060000	1672290000
15	71.12	(2.800)	50	1672070000	1672300000
16	76.20	(3.000)	50	1672080000	1672310000
17	81.28	(3.200)	20	1672090000	1672320000
18	86.36	(3.400)	20	1672100000	1672330000
19	91.44	(3.600)	20	1672110000	1672340000
20	96.52	(3.800)	20	1672120000	1672350000
21	101.60	(4.000)	20	1672130000	1672360000
22	106.68	(4.200)	20	1672140000	1672370000
23	111.76	(4.400)	20	1672150000	1672380000
24	116.84	(4.600)	20	1672160000	1672390000

BLZF 5.08/270B

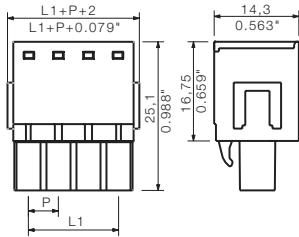

Ordering data

Solder pin length

Colour	<input checked="" type="checkbox"/> orange	<input type="checkbox"/> black
--------	--	--------------------------------

Pitch 5.08 mm

Poles	L1 mm	(inch)	Qty.	Order No.	Order No.
2	5.08	(0.200)	100	1672400000	1672630000
3	10.16	(0.400)	100	1672410000	1672640000
4	15.24	(0.600)	100	1672420000	1672650000
5	20.32	(0.800)	50	1672430000	1672660000
6	25.40	(1.000)	50	1672440000	1672670000
7	30.48	(1.200)	50	1672450000	1672680000
8	35.56	(1.400)	50	1672460000	1672690000
9	40.64	(1.600)	50	1672470000	1672700000
10	45.72	(1.800)	50	1672480000	1672710000
11	50.80	(2.000)	50	1672490000	1672720000
12	55.88	(2.200)	50	1672500000	1672730000
13	60.96	(2.400)	50	1672510000	1672740000
14	66.04	(2.600)	50	1672520000	1672750000
15	71.12	(2.800)	50	1672530000	1672760000
16	76.20	(3.000)	50	1672540000	1672770000
17	81.28	(3.200)	20	1672550000	1672780000
18	86.36	(3.400)	20	1672560000	1672790000
19	91.44	(3.600)	20	1672570000	1672800000
20	96.52	(3.800)	20	1672580000	1672810000
21	101.60	(4.000)	20	1672590000	1672820000
22	106.68	(4.200)	20	1672600000	1672830000
23	111.76	(4.400)	20	1672610000	1672840000
24	116.84	(4.600)	20	1672620000	1672850000

Accessories

Possible colors

Additional colours on request



Coding

See chapter accessories



Fixing block

See chapter accessories



Marking strips

See chapter accessories



Screwdriver

See chapter accessories
Order No. 9008390000



Socket connectors with IDC

BLIDC 5.08

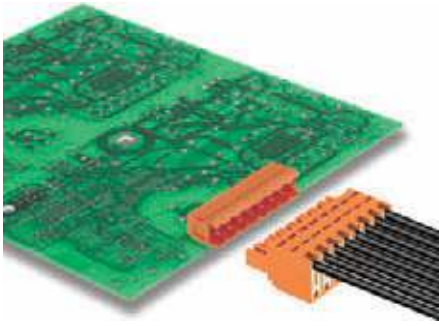

Socket connectors for conductor connection in IDC (Insulation Displacement Connection) system with straight 180° outlet direction. The socket connectors provide space for labelling and can be coded. Packaged in cardboard box.

- 0.35 - 0.75 mm² (IEC) / 22 - 20 AWG (UL)
- 400 V (IEC) / 300 V (UL)
- 11 A (IEC) / 5 A (UL)

Derating curve

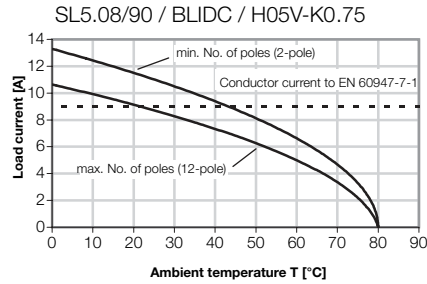

BLIDC 5.08

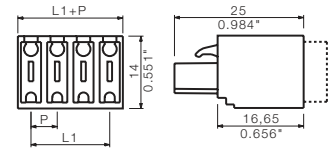

F

Technical data

Rated data to IEC 60664-1 / IEC 61984

Clamping range, max.	mm ²	0.32...0.75
Solid H05(07) V-U	mm ²	0.5...0.75
Stranded H07 V-R	mm ²	
Flexible H05(07) V-K	mm ²	0.5...0.75
Flexible with ferrule	mm ²	
Ferrule with plastic collar	mm ²	
Stripping length	mm	
Screwdriver blade	mm	0.6 x 3.5
according to norm		DIN 5264-A
Tightening torque range	Nm	

Rated current

at ambient temperature	20°C	40°C
A	11	9

Overvoltage category

	III	III	II
Pollution severity	3	2	2

Rated voltage	V	250	320	400
Rated impulse voltage	kV	4	4	4

UL 1059 rated data - E60693

	B	C	D
Rated voltage	V	300	300
Rated current	A	5	5
AWG conductor		22-20	

CSA C22.2 rated data - LR12400 B

	B	C	D
Rated voltage	V	300	300
Rated current	A	8	8
AWG conductor		22-20	

Material data

Type of insulating material	PBT
Flammability class acc. UL94	V-0
Contact base material	CuSn
Material of contact surface	tinned

Information

- Additional colours on request
- Rated current related to rated cross-section and min. No. of poles.
- for IDC contact 0.5: conductor to DIN EN 60352 pt 4
- AWG conductor: solid, 7 or 19 strands only
- Max. O.D. of conductor: 2.4 mm
- Rated data refer only to the component itself. Clearance and creepage distances to other components are to be designed in accordance with the relevant application standards.

SL5.08/90 / BLIDC / AWG22/7

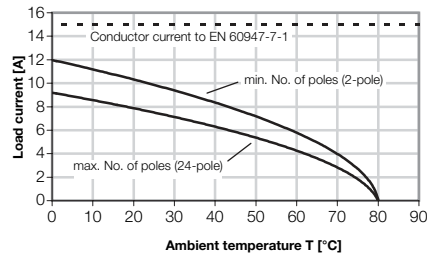

Ordering data

Solder pin length

Colour	orange	black
--------	--------	-------

Pitch 5.08 mm

Poles	L1 mm	(inch)	Qty.	Order No.	Order No.
2	5.08	(0.200)	100	1724940000	1759390000
3	10.16	(0.400)	100	1724950000	1759400000
4	15.24	(0.600)	100	1724960000	1759410000
5	20.32	(0.800)	50	1724970000	1759420000
6	25.40	(1.000)	50	1724980000	1759430000
7	30.48	(1.200)	50	1724990000	1759440000
8	35.56	(1.400)	50	1725000000	1759450000
9	40.64	(1.600)	50	1725010000	1759460000
10	45.72	(1.800)	50	1725020000	1759470000
11	50.80	(2.000)	50	1725030000	1759480000
12	55.88	(2.200)	50	1725040000	1759490000

BLIDC 5.08B

Accessories

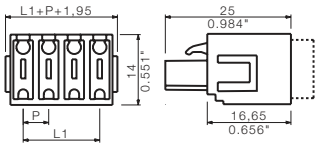

Possible colors
Additional colours on request



Coding
See chapter accessories

Ordering data

Solder pin length		Colour			
		orange	black		
Pitch 5.08 mm					
Poles	L1 mm	(inch)	Qty.	Order No.	Order No.
2	5.08	(0.200)	100	1759500000	1759610000
3	10.16	(0.400)	100	1759510000	1759620000
4	15.24	(0.600)	100	1759520000	1759630000
5	20.32	(0.800)	50	1759530000	1759640000
6	25.40	(1.000)	50	1759540000	1759650000
7	30.48	(1.200)	50	1759550000	1759660000
8	35.56	(1.400)	50	1759560000	1759670000
9	40.64	(1.600)	50	1759570000	1759680000
10	45.72	(1.800)	50	1759580000	1759690000
11	50.80	(2.000)	50	1759590000	1759700000
12	55.88	(2.200)	50	1759600000	1759710000



Fixing block
See chapter accessories



Marking strips
See chapter accessories



Mounting block
See chapter accessories



BLC 5.08BR

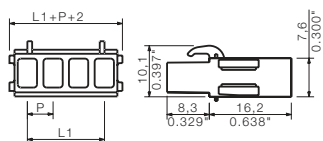

Ordering data

Solder pin length

Colour	<input type="checkbox"/> orange	<input type="checkbox"/> black
--------	---------------------------------	--------------------------------

Pitch 5.08 mm

Poles	L1 mm	(inch)	Qty.	Order No.	Order No.
2	5.08	(0.200)	100	1649370000	1712110000
3	10.16	(0.400)	100	1649380000	1712120000
4	15.24	(0.600)	100	1649390000	1712130000
5	20.32	(0.800)	50	1649400000	1712140000
6	25.40	(1.000)	50	1649410000	1712150000
7	30.48	(1.200)	50	1649420000	1712160000
8	35.56	(1.400)	50	1649430000	1712170000
9	40.64	(1.600)	50	1649440000	1712180000
10	45.72	(1.800)	50	1649450000	1712190000
11	50.80	(2.000)	50	1649460000	1712200000
12	55.88	(2.200)	50	1649470000	1712210000
13	60.96	(2.400)	50	1649480000	1712220000
14	66.04	(2.600)	50	1649490000	1712230000
15	71.12	(2.800)	50	1649500000	1712240000
16	76.20	(3.000)	50	1649510000	1712250000

Accessories

Possible colors

Additional colours on request



Coding

See chapter accessories



Fixing block

See chapter accessories



Marking strips

See chapter accessories



Crimping tool

See chapter accessories

DFFC - crimp contact



Ordering data

supplied as separate contacts, tinned

for cable size	Qty.	Order No.
0.22 – 0.35 mm ² / 24 – 22 AWG	250	1604250000
0.50 – 1.00 mm ² / 20 – 17 AWG	250	1567060000
1.50 – 2.50 mm ² / 16 – 14 AWG	250	1567070000

Ordering data

supplied on a strip, tinned

for cable size	Qty.	Order No.
0.22 – 0.35 mm ² / 24 – 22 AWG	3000	1604230000
0.50 – 1.00 mm ² / 20 – 17 AWG	3000	1480000000
1.50 – 2.50 mm ² / 16 – 14 AWG	3000	1480100000

BLL 5.08/90FI

Accessories

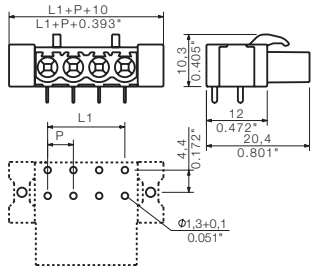

Possible colors

Additional colours on request



Coding

See chapter accessories

Ordering data

Solder pin length	3.2 mm
Colour	orange

Pitch 5.08 mm

Poles	L1 mm	(inch)	Qty.	Order No.	Order No.
2	5.08	(0.200)	100		1843750000
3	10.16	(0.400)	100		1843760000
4	15.24	(0.600)	100		1843770000
5	20.32	(0.800)	50		1843780000
6	25.40	(1.000)	50		1843790000
7	30.48	(1.200)	50		1843800000
8	35.56	(1.400)	50		1843810000
9	40.64	(1.600)	50		1843820000
10	45.72	(1.800)	50		1843830000
11	50.80	(2.000)	50		1843840000
12	55.88	(2.200)	50		1843850000
13	60.96	(2.400)	50		1843860000
14	66.04	(2.600)	50		1843870000
15	71.12	(2.800)	50		1843880000
16	76.20	(3.000)	50		1843890000
17	81.28	(3.200)	20		1843900000
18	86.36	(3.400)	20		1843910000
19	91.44	(3.600)	20		1843920000
20	96.52	(3.800)	20		1843930000
21	101.60	(4.000)	20		1843940000
22	106.68	(4.200)	20		1843950000
23	111.76	(4.400)	20		1843960000
24	116.84	(4.600)	20		1843970000



BLL 5.08/180B

Accessories

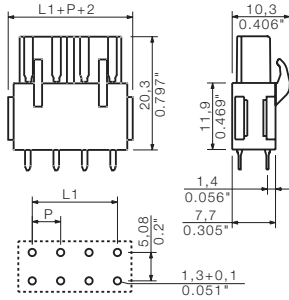

Possible colors

Additional colours on request



Coding

See chapter accessories

Ordering data

Solder pin length	3.2 mm
Colour	orange

Pitch 5.08 mm

Poles	L1 mm	(inch)	Qty.	Order No.	Order No.
2	5.08	(0.200)	100		1682730000
3	10.16	(0.400)	100		1682740000
4	15.24	(0.600)	100		1682750000
5	20.32	(0.800)	50		1682760000
6	25.40	(1.000)	50		1682770000
7	30.48	(1.200)	50		1682780000
8	35.56	(1.400)	50		1682790000
9	40.64	(1.600)	50		1682800000
10	45.72	(1.800)	50		1682810000
11	50.80	(2.000)	50		1682820000
12	55.88	(2.200)	50		1682830000
13	60.96	(2.400)	50		1682840000
14	66.04	(2.600)	50		1682850000
15	71.12	(2.800)	50		1682860000
16	76.20	(3.000)	50		1682870000
17	81.28	(3.200)	20		1682880000
18	86.36	(3.400)	20		1682890000
19	91.44	(3.600)	20		1682900000
20	96.52	(3.800)	20		1682910000
21	101.60	(4.000)	20		1682920000
22	106.68	(4.200)	20		1682930000
23	111.76	(4.400)	20		1682940000
24	116.84	(4.600)	20		1682950000



Fixing block

See chapter accessories



