

# C5D25170H

## Silicon Carbide Schottky Diode

### Z-REC<sup>®</sup> RECTIFIER

|                              |   |        |
|------------------------------|---|--------|
| $V_{RRM}$                    | = | 1700 V |
| $I_F(T_c=135^\circ\text{C})$ | = | 33.6 A |
| $Q_c$                        | = | 255 nC |

#### Features

- 1.7kV Schottky Rectifier
- Zero Reverse Recovery Current
- High-Frequency Operation
- Temperature-Independent Switching
- Extremely Fast Switching
- Positive Temperature Coefficient on  $V_F$

#### Benefits

- Replace Bipolar with Unipolar Rectifiers
- Essentially No Switching Losses
- Higher Efficiency
- Reduction of Heat Sink Requirements
- Parallel Devices Without Thermal Runaway

#### Applications

- Switch Mode Power Supplies (SMPS)
- Boost diodes in PFC or DC/DC stages
- Free Wheeling Diodes in Inverter stages
- 1500V Solar Inverter

#### Package



TO-247-2



| Part Number | Package  | Marking  |
|-------------|----------|----------|
| C5D25170H   | TO-247-2 | C5D25170 |

#### Maximum Ratings ( $T_c=25^\circ\text{C}$ unless otherwise specified)

| Symbol         | Parameter                                  | Value              | Unit             | Test Conditions                                                                                                                       | Note   |
|----------------|--------------------------------------------|--------------------|------------------|---------------------------------------------------------------------------------------------------------------------------------------|--------|
| $V_{RRM}$      | Repetitive Peak Reverse Voltage            | 1700               | V                |                                                                                                                                       |        |
| $V_R$          | DC Peak Reverse Voltage                    | 1700               | V                |                                                                                                                                       |        |
| $I_F$          | Continuous Forward Current                 | 70<br>33.6<br>25.6 | A                | $T_c=25^\circ\text{C}$<br>$T_c=135^\circ\text{C}$<br>$T_c=150^\circ\text{C}$                                                          | Fig. 3 |
| $I_{FRM}$      | Repetitive Peak Forward Surge Current      | 99<br>57           | A                | $T_c=25^\circ\text{C}, t_p=10\text{ ms}, \text{Half Sine Pulse}$<br>$T_c=110^\circ\text{C}, t_p=10\text{ ms}, \text{Half Sine Pulse}$ |        |
| $I_{FSM}$      | Non-Repetitive Forward Surge Current       | 117<br>88          | A                | $T_c=25^\circ\text{C}, t_p=10\text{ ms}, \text{Half Sine Pulse}$<br>$T_c=110^\circ\text{C}, t_p=10\text{ ms}, \text{Half Sine Pulse}$ |        |
| $P_{tot}$      | Power Dissipation                          | 384<br>167         | W                | $T_c=25^\circ\text{C}$<br>$T_c=110^\circ\text{C}$                                                                                     | Fig. 4 |
| $T_J, T_{stg}$ | Operating Junction and Storage Temperature | -55 to<br>+175     | $^\circ\text{C}$ |                                                                                                                                       |        |
|                | TO-247 Mounting Torque                     | 1<br>8.8           | Nm<br>lbf-in     | M3 Screw<br>6-32 Screw                                                                                                                |        |

### Electrical Characteristics

| Symbol | Parameter                 | Typ.               | Max.       | Unit          | Test Conditions                                                                                                                                                                                   | Note   |
|--------|---------------------------|--------------------|------------|---------------|---------------------------------------------------------------------------------------------------------------------------------------------------------------------------------------------------|--------|
| $V_F$  | Forward Voltage           | 1.5<br>2.5         | 1.8<br>3.0 | V             | $I_F = 25\text{ A } T_J = 25^\circ\text{C}$<br>$I_F = 25\text{ A } T_J = 175^\circ\text{C}$                                                                                                       | Fig. 1 |
| $I_R$  | Reverse Current           | 20<br>120          | 200<br>300 | $\mu\text{A}$ | $V_R = 1700\text{ V } T_J = 25^\circ\text{C}$<br>$V_R = 1700\text{ V } T_J = 175^\circ\text{C}$                                                                                                   | Fig. 2 |
| $Q_C$  | Total Capacitive Charge   | 255                |            | nC            | $V_R = 1700\text{ V}, I_F = 25\text{ A}$<br>$di/dt = 200\text{ A}/\mu\text{s}$<br>$T_J = 25^\circ\text{C}$                                                                                        | Fig. 5 |
| C      | Total Capacitance         | 1950<br>190<br>140 |            | pF            | $V_R = 0\text{ V}, T_J = 25^\circ\text{C}, f = 1\text{ MHz}$<br>$V_R = 800\text{ V}, T_J = 25^\circ\text{C}, f = 1\text{ MHz}$<br>$V_R = 1700\text{ V}, T_J = 25^\circ\text{C}, f = 1\text{ MHz}$ | Fig. 6 |
| $E_C$  | Capacitance Stored Energy | 175                |            | $\mu\text{J}$ | $V_R = 1700\text{ V}$                                                                                                                                                                             | Fig. 7 |

Note: This is a majority carrier diode, so there is no reverse recovery charge.

### Thermal Characteristics

| Symbol          | Parameter                                | Typ. | Unit                      | Note   |
|-----------------|------------------------------------------|------|---------------------------|--------|
| $R_{\theta JC}$ | Thermal Resistance from Junction to Case | 0.39 | $^\circ\text{C}/\text{W}$ | Fig. 8 |

### Typical Performance

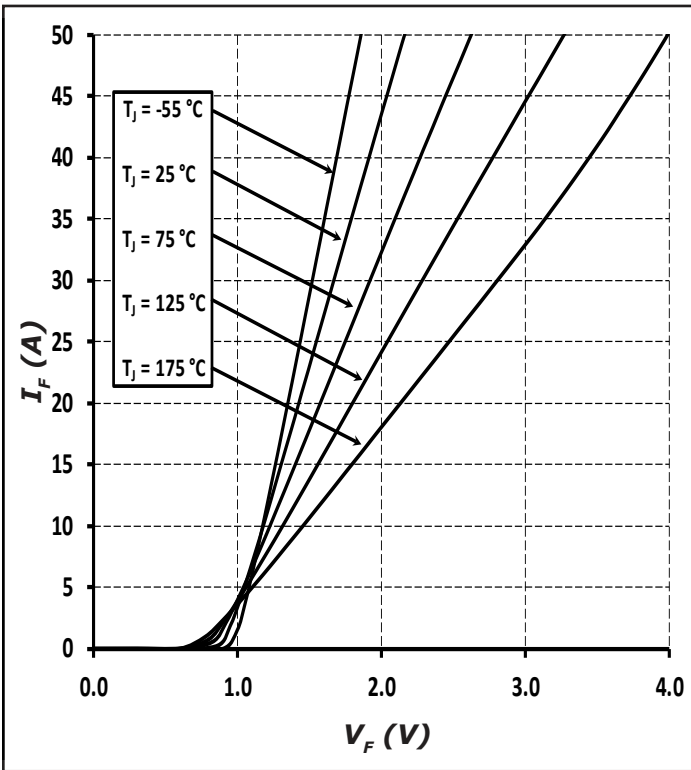

Figure 1. Forward Characteristics

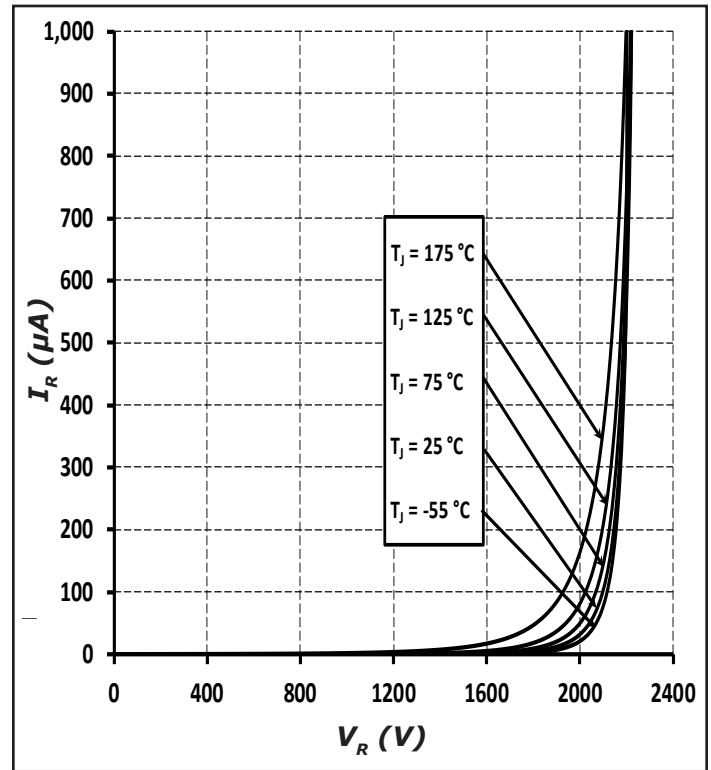

Figure 2. Reverse Characteristics

## Typical Performance

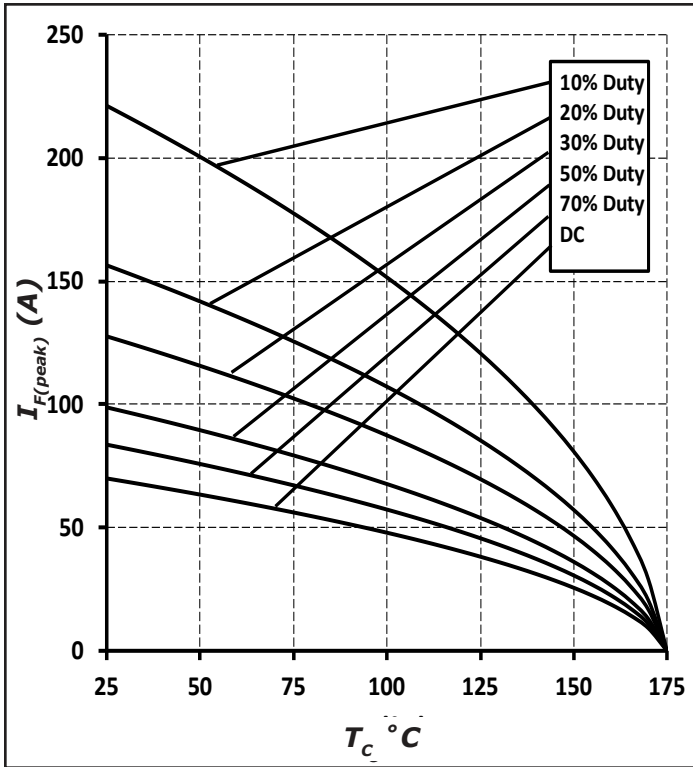

Figure 3. Current Derating

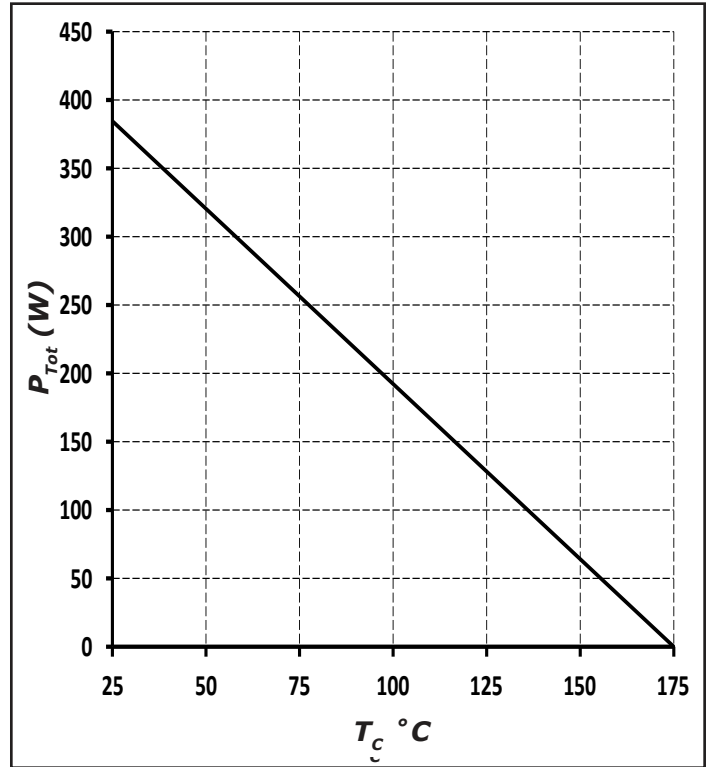

Figure 4. Power Derating

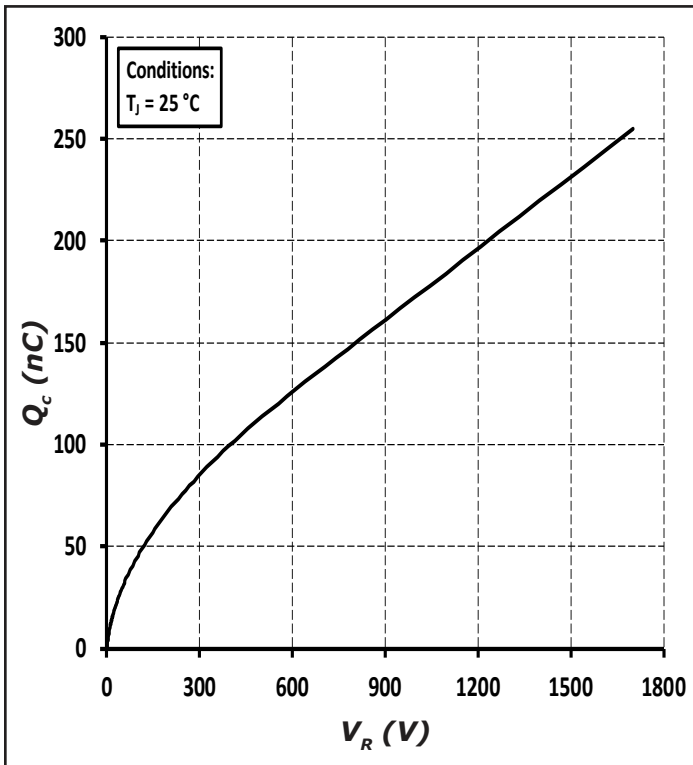

Figure 5. Recovery Charge vs. Reverse Voltage

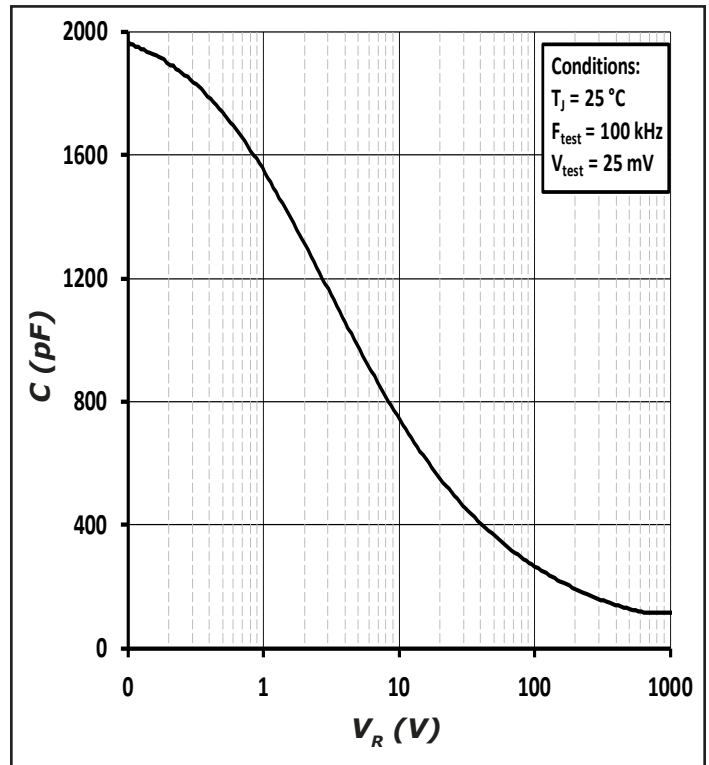

Figure 6. Capacitance vs. Reverse Voltage

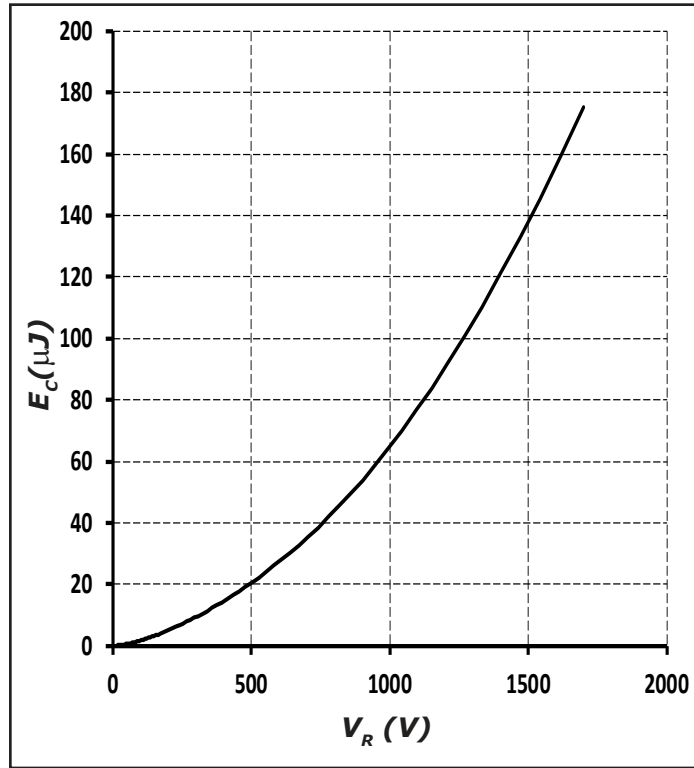

Figure 7. Typical Capacitance Stored Energy

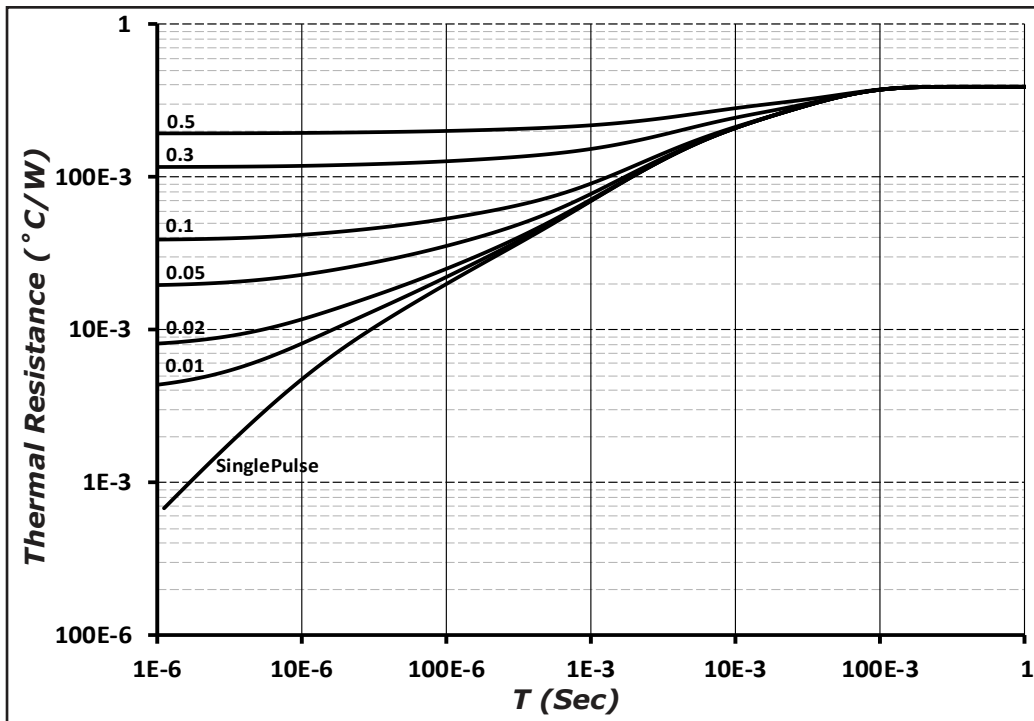
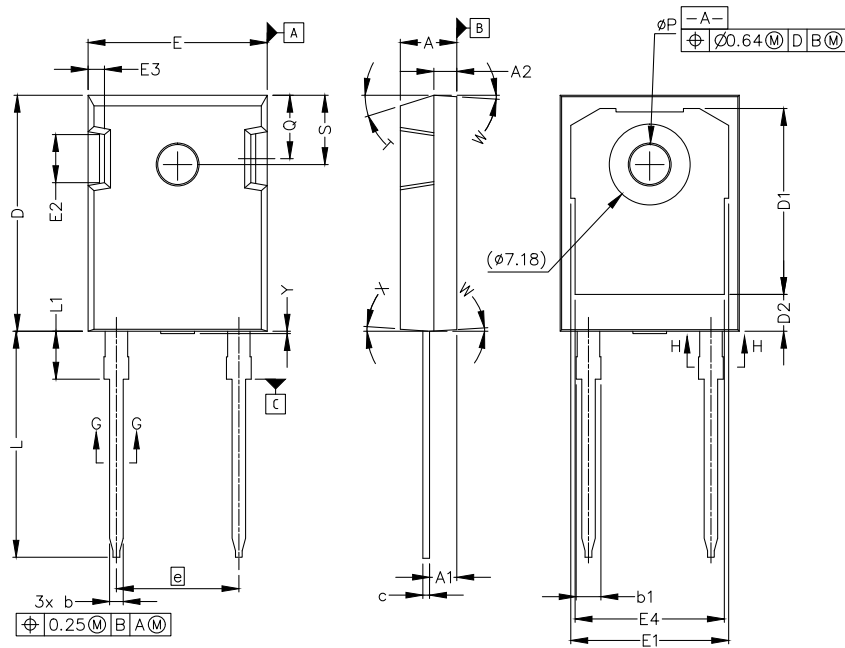

Figure 8. Transient Thermal Impedance

## Package Dimensions

Package TO-247-2



| POS | Inches     |       | Millimeters |       |
|-----|------------|-------|-------------|-------|
|     | Min        | Max   | Min         | Max   |
| A   | 0.190      | 0.205 | 4.70        | 5.31  |
| A1  | 0.087      | 0.102 | 2.21        | 2.59  |
| A2  | 0.059      | 0.098 | 1.50        | 2.49  |
| b   | 0.039      | 0.055 | 0.99        | 1.40  |
| b1  | 0.065      | 0.095 | 1.65        | 2.41  |
| c   | 0.015      | 0.035 | 0.38        | 0.89  |
| D   | 0.819      | 0.845 | 20.80       | 21.46 |
| D1  | 0.640      | 0.683 | 16.25       | 17.35 |
| D2  | 0.112      | 0.124 | 2.86        | 3.16  |
| E   | 0.620      | 0.640 | 15.49       | 16.26 |
| E1  | 0.516      | 0.557 | 13.10       | 14.15 |
| E2  | 0.135      | 0.201 | 3.43        | 5.10  |
| E3  | 0.039      | 0.075 | 1.00        | 1.90  |
| E4  | 0.487      | 0.529 | 12.38       | 13.43 |
| e   | 0.428 BSC  |       | 10.88 BSC   |       |
| L   | 0.78       | 0.80  | 19.81       | 20.32 |
| L1  | -          | 0.177 | -           | 4.50  |
| ØP  | 0.138      | 0.144 | 3.51        | 3.66  |
| Q   | 0.212      | 0.244 | 5.38        | 6.20  |
| S   | 0.238      | 0.248 | 6.04        | 6.3   |
| T   | 17.5° REF. |       |             |       |
| W   | 3.5° REF.  |       |             |       |
| X   | 4° REF.    |       |             |       |
| Y   | 0          | 0.5   | 0           | 0.02  |

## Recommended Solder Pad Layout

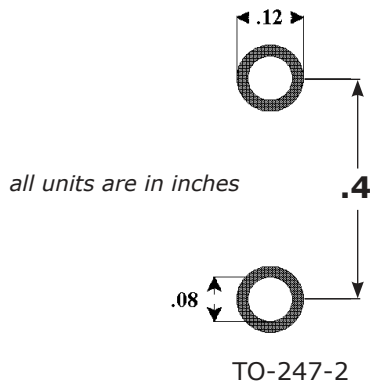

| Part Number | Package  | Marking  |
|-------------|----------|----------|
| C5D25170H   | TO-247-2 | C5D25170 |

Note: Recommended soldering profiles can be found in the applications note here: [http://www.wolfspeed.com/power\\_app\\_notes/soldering](http://www.wolfspeed.com/power_app_notes/soldering)



## Diode Model

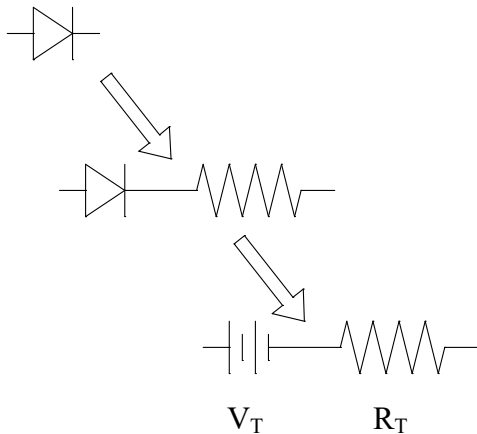

$$V_{fT} = V_T + I_f R_T$$

$$V_T = 0.94 + (T_J * -1.0 * 10^{-3})$$

$$R_T = 0.027 + (T_J * 2.8 * 10^{-4})$$

Note:  $T_J$  = Diode Junction Temperature In Degrees Celsius,  
valid from 25°C to 175°C

## Notes

- RoHS Compliance**  
 The levels of RoHS restricted materials in this product are below the maximum concentration values (also referred to as the threshold limits) permitted for such substances, or are used in an exempted application, in accordance with EU Directive 2011/65/EC (RoHS2), as implemented January 2, 2013. RoHS Declarations for this product can be obtained from your Wolfspeed representative or from the Product Ecology section of our website at <http://www.wolfspeed.com/power/tools-and-support/product-ecology>.
- REACH Compliance**  
 REACH substances of high concern (SVHCs) information is available for this product. Since the European Chemical Agency (ECHA) has published notice of their intent to frequently revise the SVHC listing for the foreseeable future, please contact a Cree representative to insure you get the most up-to-date REACH SVHC Declaration. REACH banned substance information (REACH Article 67) is also available upon request.
- This product has not been designed or tested for use in, and is not intended for use in, applications implanted into the human body nor in applications in which failure of the product could lead to death, personal injury or property damage, including but not limited to equipment used in the operation of nuclear facilities, life-support machines, cardiac defibrillators or similar emergency medical equipment, aircraft navigation or communication or control systems, or air traffic control systems.

## Related Links

- Cree SiC Schottky diode portfolio: <http://www.wolfspeed.com/Power/Products#SiCSchottkyDiodes>
- Schottky diode Spice models: <http://www.wolfspeed.com/power/tools-and-support/DIODE-model-request2>
- SiC MOSFET and diode reference designs: <http://go.pardot.com/l/101562/2015-07-31/349i>